

# Verkaufshandbuch 2022/23

## *Sales Catalogue 2022/23*



®  
**MARLIN**



## Qualitätsmöbel aus Deutschland Quality furniture from Germany

### Verkäuferschulungen

Gerne informieren wir Ihre Mitarbeiter/Innen in einem Zwei-Tagesseminar über die unterschiedlichen Anforderungen und umfangreichen Lösungen unserer Badmöbel.

Unsere Gebietsverkaufsleiter oder die Marketingabteilung steht Ihnen dabei zur Verfügung.  
stefanie.sudeck@jaka-bkl.de

### Sales training

We would be pleased to inform your staff in a two-day seminar about the different requirements and comprehensive solutions of our bathroom furniture.

Our area sales managers or the marketing department are at your disposal:  
stefanie.sudeck@jaka-bkl.de

Unsere Schulungstermine finden Sie online:  
Our sales trainings appointments online:



Selbstverständlich:

- ▶ Metall-Vollauszüge bei Schubkästen und Auszügen
- ▶ Softclose

Of course:

- ▶ Full extension metal slides drawers and pull-outs
- ▶ Soft close



Selbstverständlich:

- ▶ Türdämpfer

Of course:

- ▶ Door damper

Wir möchten, dass Sie schnell und einwandfrei beliefert werden. Denken Sie bitte daran, dass ein Auftrag erst dann zur Fertigung eingeplant wird, wenn alle Angaben vollständig sind und die entsprechend notwendigen Zeichnungen im Werk vorliegen.

Technische Änderungen, die der Weiterentwicklung dienen sowie kleine Modell- und Farbabweichungen bleiben uns vorbehalten, ebenso Druckfehler und Irrtümer. Mit Herausgabe dieser Liste verlieren alle bisherigen ihre Gültigkeit.  
**Alle Preisfelder enthalten Identnummern.**

Wir fertigen in Deutschland. Und das seit über 50 Jahren.

We want you to be supplied quickly and flawlessly. Please remember that an order is not scheduled for production until all information is complete and the necessary drawings are available in the factory.

We reserve the right to make technical changes that serve further development and small model and color deviations, as well as misprints and errors. With the publication of this list, all previous ones lose their validity.

**All the price boxes contain ID numbers.**

We manufacture in Germany. And that for more than 50 years.



JAKA-BKL GmbH | Jaka-Str. 3 | 32351 Stemwede  
Tel. +49 (0) 5773 / 88-0  
www.marlinbad.de | info@jaka-bkl.de



news

NEWS







# 3500maxus





# »3500maxus«

Piktogramme/pictograms



Keramik Waschtisch  
Ceramic washbasin



LED Lichtfarbe warm  
LED colour temperature warm



LED mit Sensorschalter,  
Helligkeit dimmbar  
LED with sensor switch,  
brightness dimmable

## Keramik Waschbecken weiß alpin Glanz (GSK) Ceramic on-top washbasin gloss alpine white (GSK)

≈ Beckenmaße in cm (BxHxT)  
basin dimensions in cm (WxHxD)

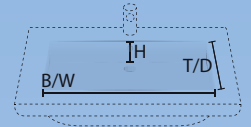

### One - Cubic



KWHER6 | 56 x 10 x 28 cm



Detail



### One - Round



KWONE4 | 38 x 11,5 x 28 cm



Detail



### Olive



KWOLI75 | 64 x 12 x 34 cm



Detail



### Rumba



KWAWG6 | 59,6 x 9,9 x 32,7 cm



**Weiß Glanz**  
Gloss White  
GSK



**Schwarz Matt**  
Matt Black  
GSKB



Detail

## Waschtischplattenfarben/washbasin plate colours

19 mm Plattenstärke/plate thickness



**Eiche Struktur Natur Nachbildung**  
Oak Structure Nature Finish  
GS55



**Schwarz Supermatt**  
Black Super Matt  
GS88

## Tischgestellfarben/table frame colours

## Spiegelschrank Korpusfarben/ mirror cabinet basic shell colours



**Eiche Struktur Natur Nachbildung**  
Oak Structure Nature Finish  
GS55



**Schwarz Supermatt**  
Black Super Matt  
GS25

## Schränke/cabinets 3500maxus

## Frontfarben/front colours

Dickkante/thick edge



**611**  
**Weiß Supermatt**  
White Super Matt  
GSP\_



**401**  
**Schwarz Supermatt**  
Black Super Matt  
GSS\_



**473**  
**Eiche Struktur Natur Nachbildung**  
Oak Structure Nature Finish  
GSM\_



**435**  
**Eiche Struktur Weiß Nachbildung**  
Oak Structure White Finish  
GSL\_



**426**  
**Eiche Struktur Braun Nachbildung**  
Oak Structure Brown Finish  
GSH\_

## Korpusfarben/basic shell colours

PG 1 Dickkante/thick edge



**611**  
**Weiß Supermatt**  
White Super Matt  
P



**401**  
**Schwarz Supermatt**  
Black Super Matt  
S



**473**  
**Eiche Struktur Natur Nachbildung**  
Oak Structure Nature Finish  
M



**435**  
**Eiche Struktur Weiß Nachbildung**  
Oak Structure White Finish  
L



**426**  
**Eiche Struktur Braun Nachbildung**  
Oak Structure Brown Finish  
H



## Griffleiste/handle bar



**Aluminium Matt**  
*Matt aluminium*

## Beleuchtung / lighting









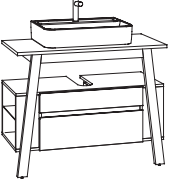

**Integrierte Aufbauleuchte LED**  
*Integrated top light LED*

**Lichtfarbe Wohlfühllicht (Warm)**  
*Luminous colour warm light*



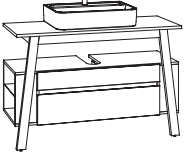

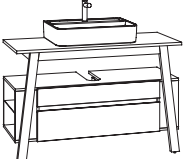







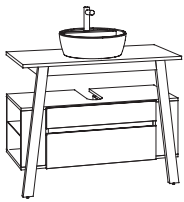



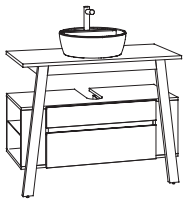

**Die Steckdose / Powerbox für Spiegelschränke ist auch in Ausführung für die Schweiz / Frankreich erhältlich. Bitte Mehrpreis beachten (siehe Seite 10).**  
*The power socket for mirror cabinets is also available for Switzerland / France. Please note extra charge (see page 10).*

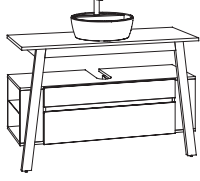
# 3500maxus »Sets mit Waschtisch One-Cubic/sets with washbasin One-Cubic«

Beschreibung Description	Maße in cm Dimensions in cm			Artikel-Nr. Article no.	Türanschlag Door stop	Identnummer ID number
	B/W	H	T/D			
PG1						
 <p><b>Set 100 cm bestehend aus:</b>  Aufsatz-Keramik-Waschtisch <b>One-Cubic</b>  Waschtischplatte 19 mm im Dekor  <b>Eiche Struktur Natur Nachbildung</b>  Waschtischunterschrank, 1 Schubkasten,  1 Auszug, 2 offene Fächer inkl. Glasein-  geboden  Tischgestell im Dekor <b>Eiche Struktur Natur  Nachbildung</b></p> <p><b>Set 100 cm width consisting of:</b>  on-top ceramic washbasin <b>One-Cubic</b>  washbasin plate 19 mm in the decor  <b>oak structure nature finish</b>  washbasin base cabinet, 1 drawer,  1 extension and 2 open compartments  incl. glass shelves  table frame in the decor <b>oak structure  nature finish</b></p>	100,4	92,9	48,5	GHSA10HM		4188
	60,0	14,0	42,0			Waschtischplatte und Tischgestell im Dekor <b>Eiche Struktur Natur Nachbildung</b>
 <p><b>Set 100 cm bestehend aus:</b>  Aufsatz-Keramik-Waschtisch <b>One-Cubic</b>  Waschtischplatte 19 mm im Dekor  <b>Schwarz Supermatt</b>  Waschtischunterschrank, 1 Schubkasten,  1 Auszug, 2 offene Fächer inkl. Glasein-  geboden  Tischgestell im Dekor <b>Schwarz Supermatt</b></p> <p><b>Set 100 cm width consisting of:</b>  on-top ceramic washbasin <b>One-Cubic</b>  washbasin plate 19 mm in the decor  <b>black super matt</b>  washbasin base cabinet, 1 drawer,  1 extension and 2 open compartments  incl. glass shelves  table frame in the decor <b>black super matt</b></p>	100,4	92,9	48,5	GHSA10HS		4457
	60,0	14,0	42,0			Waschtischplatte und Tischgestell im Dekor <b>Schwarz Supermatt</b>
 <p><b>Set 120 cm bestehend aus:</b>  Aufsatz-Keramik-Waschtisch <b>One-Cubic</b>  Waschtischplatte 19 mm im Dekor  <b>Eiche Struktur Natur Nachbildung</b>  Waschtischunterschrank, 1 Schubkasten,  1 Auszug, 2 offene Fächer inkl. Glasein-  geboden  Tischgestell im Dekor <b>Eiche Struktur Natur  Nachbildung</b></p> <p><b>Set 120 cm width consisting of:</b>  on-top ceramic washbasin <b>One-Cubic</b>  washbasin plate 19 mm in the decor  <b>oak structure nature finish</b>  washbasin base cabinet, 1 drawer,  1 extension and 2 open compartments  incl. glass shelves  table frame in the decor <b>oak structure  nature finish</b></p>	120,4	92,9	48,5	GHSA12HM		4434
	60,0	14,0	42,0			Waschtischplatte und Tischgestell im Dekor <b>Eiche Struktur Natur Nachbildung</b>
 <p><b>Set 120 cm bestehend aus:</b>  Aufsatz-Keramik-Waschtisch <b>One-Cubic</b>  Waschtischplatte 19 mm im Dekor  <b>Schwarz Supermatt</b>  Waschtischunterschrank, 1 Schubkasten,  1 Auszug, 2 offene Fächer inkl. Glasein-  geboden  Tischgestell im Dekor <b>Schwarz Supermatt</b></p> <p><b>Set 120 cm width consisting of:</b>  on-top ceramic washbasin <b>One-Cubic</b>  washbasin plate 19 mm in the decor  <b>black super matt</b>  washbasin base cabinet, 1 drawer,  1 extension and 2 open compartments  incl. glass shelves  table frame in the decor <b>black super matt</b></p>	120,4	92,9	48,5	GHSA12HS		4770
	60,0	14,0	42,0			Waschtischplatte und Tischgestell im Dekor <b>Schwarz Supermatt</b>

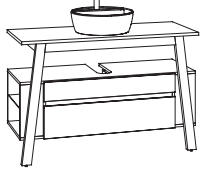













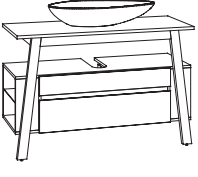

**i** Der Waschtisch One-Cubic wird inkl. Permanentablauf in Farbe Chrom geliefert. Anschluß durch Kunden.  
The One-Cubic washbasin is supplied with a permanent drain in colour chrome. Installation by customer.

# 3500maxus »Sets mit Waschtisch One-Round/sets with washbasin One-Round«

Beschreibung Description	Maße in cm Dimensions in cm			Artikel-Nr. Article no.	Türanschlag Door stop	Identnummer ID number						
	B/W	H	T/D									
PG1												
 <p><b>Set 100 cm bestehend aus:</b>                      Aufsatz-Keramik-Waschtisch <b>One-Round</b>                      Waschtischplatte 19 mm im Dekor  <b>Eiche Struktur Natur Nachbildung</b>                      Waschtischunterschrank, 1 Schubkasten,                      1 Auszug, 2 offene Fächer inkl. Glaseinlegeboden                      Tischgestell im Dekor <b>Eiche Struktur Natur Nachbildung</b></p> <p><b>Set 100 cm width consisting of:</b>                      on-top ceramic washbasin <b>One-Round</b>                      washbasin plate 19 mm in the decor  <b>oak structure nature finish</b>                      washbasin base cabinet, 1 drawer,                      1 extension and 2 open compartments                      incl. glass shelves                      table frame in the decor <b>oak structure nature finish</b></p>	100,4	92,9	48,5	GHSA10NM		3852  Waschtischplatte und Tischgestell im Dekor <b>Eiche Struktur Natur Nachbildung</b>    washbasin plate and table frame in the decor <b>oak structure nature finish</b>  						
	42,0	14,0	42,0				42,0	100,4	1,9	48,5	100,0	36,7
 <p><b>Set 100 cm bestehend aus:</b>                      Aufsatz-Keramik-Waschtisch <b>One-Round</b>                      Waschtischplatte 19 mm im Dekor  <b>Schwarz Supermatt</b>                      Waschtischunterschrank, 1 Schubkasten,                      1 Auszug, 2 offene Fächer inkl. Glaseinlegeboden                      Tischgestell im Dekor <b>Schwarz Supermatt</b></p> <p><b>Set 100 cm width consisting of:</b>                      on-top ceramic washbasin <b>One-Round</b>                      washbasin plate 19 mm in the decor  <b>black super matt</b>                      washbasin base cabinet, 1 drawer,                      1 extension and 2 open compartments                      incl. glass shelves                      table frame in the decor <b>black super matt</b></p>	100,4	92,9	48,5	GHSA10NS		4121  Waschtischplatte und Tischgestell im Dekor <b>Schwarz Supermatt</b>    washbasin plate and table frame in the decor <b>black super matt</b>  						
	42,0	14,0	42,0				42,0	100,4	1,9	48,5	100,0	36,7
 <p><b>Set 120 cm bestehend aus:</b>                      Aufsatz-Keramik-Waschtisch <b>One-Round</b>                      Waschtischplatte 19 mm im Dekor  <b>Eiche Struktur Natur Nachbildung</b>                      Waschtischunterschrank, 1 Schubkasten,                      1 Auszug, 2 offene Fächer inkl. Glaseinlegeboden                      Tischgestell im Dekor <b>Eiche Struktur Natur Nachbildung</b></p> <p><b>Set 120 cm width consisting of:</b>                      on-top ceramic washbasin <b>One-Round</b>                      washbasin plate 19 mm in the decor  <b>oak structure nature finish</b>                      washbasin base cabinet, 1 drawer,                      1 extension and 2 open compartments                      incl. glass shelves                      table frame in the decor <b>oak structure nature finish</b></p>	120,4	92,9	48,5	GHSA12NM		4098  Waschtischplatte und Tischgestell im Dekor <b>Eiche Struktur Natur Nachbildung</b>    washbasin plate and table frame in the decor <b>oak structure nature finish</b>  						
	42,0	14,0	42,0				42,0	120,4	1,9	48,5	120,0	36,7
 <p><b>Set 120 cm bestehend aus:</b>                      Aufsatz-Keramik-Waschtisch <b>One-Round</b>                      Waschtischplatte 19 mm im Dekor  <b>Schwarz Supermatt</b>                      Waschtischunterschrank, 1 Schubkasten,                      1 Auszug, 2 offene Fächer inkl. Glaseinlegeboden                      Tischgestell im Dekor <b>Schwarz Supermatt</b></p> <p><b>Set 120 cm width consisting of:</b>                      on-top ceramic washbasin <b>One-Round</b>                      washbasin plate 19 mm in the decor  <b>black super matt</b>                      washbasin base cabinet, 1 drawer,                      1 extension and 2 open compartments                      incl. glass shelves                      table frame in the decor <b>black super matt</b></p>	120,4	92,9	48,5	GHSA12NS		4434  Waschtischplatte und Tischgestell im Dekor <b>Schwarz Supermatt</b>    washbasin plate and table frame in the decor <b>black super matt</b>  						
	42,0	14,0	42,0				42,0	120,4	1,9	48,5	120,0	36,7

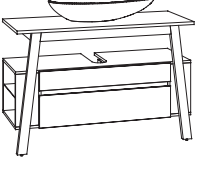
**i** Der Waschtisch One-Round wird inkl. Permanentablauf in Farbe Chrom geliefert. Anschluß durch Kunden.  
 The One-Round washbasin is supplied with a permanent drain in colour chrome. Installation by customer.

# 3500maxus »Sets mit Waschtisch Olive/sets with washbasin Olive«







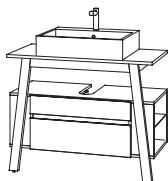

Beschreibung Description	Maße in cm Dimensions in cm			Artikel-Nr. Article no.	Türanschlag Door stop	Identnummer ID number
	B/W	H	T/D			
PG1						
 <p><b>Set 100 cm bestehend aus:</b>  Aufsatz-Keramik-Waschtisch <b>Olive</b>  Waschtischplatte 19 mm im Dekor <b>Eiche Struktur Natur Nachbildung</b>  Waschtischunterschrank, 1 Schubkasten, 1 Auszug, 2 offene Fächer inkl. Glaseinlegeboden  Tischgestell im Dekor <b>Eiche Struktur Natur Nachbildung</b></p> <p><b>Set 100 cm width consisting of:</b>  on-top ceramic washbasin <b>Olive</b>  washbasin plate 19 mm in the decor <b>oak structure nature finish</b>  washbasin base cabinet, 1 drawer, 1 extension and 2 open compartments incl. glass shelves  table frame in the decor <b>oak structure nature finish</b></p>	100,4	93,4	48,5	GHSA10LM		4345 Waschtischplatte und Tischgestell im Dekor <b>Eiche Struktur Natur Nachbildung</b>   washbasin plate and table frame in the decor <b>oak structure nature finish</b> 
	74,0	14,5	38,5			
 <p><b>Set 100 cm bestehend aus:</b>  Aufsatz-Keramik-Waschtisch <b>Olive</b>  Waschtischplatte 19 mm im Dekor <b>Schwarz Supermatt</b>  Waschtischunterschrank, 1 Schubkasten, 1 Auszug, 2 offene Fächer inkl. Glaseinlegeboden  Tischgestell im Dekor <b>Schwarz Supermatt</b></p> <p><b>Set 100 cm width consisting of:</b>  on-top ceramic washbasin <b>Olive</b>  washbasin plate 19 mm in the decor <b>black super matt</b>  washbasin base cabinet, 1 drawer, 1 extension and 2 open compartments incl. glass shelves  table frame in the decor <b>black super matt</b></p>	100,4	93,4	48,5	GHSA10LS		4614 Waschtischplatte und Tischgestell im Dekor <b>Schwarz Supermatt</b>   washbasin plate and table frame in the decor <b>black super matt</b> 
	74,0	14,5	38,5			
 <p><b>Set 120 cm bestehend aus:</b>  Aufsatz-Keramik-Waschtisch <b>Olive</b>  Waschtischplatte 19 mm im Dekor <b>Eiche Struktur Natur Nachbildung</b>  Waschtischunterschrank, 1 Schubkasten, 1 Auszug, 2 offene Fächer inkl. Glaseinlegeboden  Tischgestell im Dekor <b>Eiche Struktur Natur Nachbildung</b></p> <p><b>Set 120 cm width consisting of:</b>  on-top ceramic washbasin <b>Olive</b>  washbasin plate 19 mm in the decor <b>oak structure nature finish</b>  washbasin base cabinet, 1 drawer, 1 extension and 2 open compartments incl. glass shelves  table frame in the decor <b>oak structure nature finish</b></p>	120,4	93,4	48,5	GHSA12LM		4591 Waschtischplatte und Tischgestell im Dekor <b>Eiche Struktur Natur Nachbildung</b>   washbasin plate and table frame in the decor <b>oak structure nature finish</b> 
	74,0	14,5	38,5			
 <p><b>Set 120 cm bestehend aus:</b>  Aufsatz-Keramik-Waschtisch <b>Olive</b>  Waschtischplatte 19 mm im Dekor <b>Schwarz Supermatt</b>  Waschtischunterschrank, 1 Schubkasten, 1 Auszug, 2 offene Fächer inkl. Glaseinlegeboden  Tischgestell im Dekor <b>Schwarz Supermatt</b></p> <p><b>Set 120 cm width consisting of:</b>  on-top ceramic washbasin <b>Olive</b>  washbasin plate 19 mm in the decor <b>black super matt</b>  washbasin base cabinet, 1 drawer, 1 extension and 2 open compartments incl. glass shelves  table frame in the decor <b>black super matt</b></p>	120,4	93,4	48,5	GHSA12LS		4927 Waschtischplatte und Tischgestell im Dekor <b>Schwarz Supermatt</b>   washbasin plate and table frame in the decor <b>black super matt</b> 
	74,0	14,5	38,5			

**i** Der Waschtisch Olive wird inkl. Permanentablauf in Farbe Chrom geliefert. Anschluß durch Kunden. Es wird eine Stand- oder Wandarmatur benötigt.  
The Olive washbasin is supplied with a permanent drain in colour chrome. Installation by customer. A floor-standing or wall-mounted fitting is required.

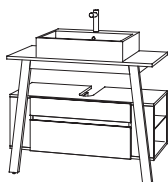
3500maxus »Sets mit Waschtisch Rumba Weiß Glanz/sets with washbasin Rumba gloss white«

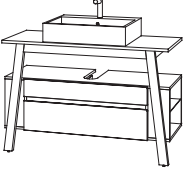
Beschreibung Description	Maße in cm Dimensions in cm			Artikel-Nr. Article no.	Türanschlag Door stop	Identnummer ID number
	B/W	H	T/D			

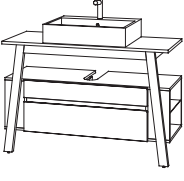





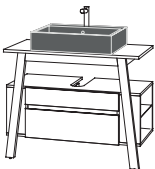
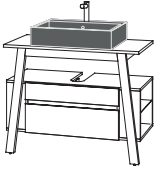
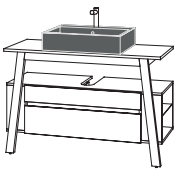
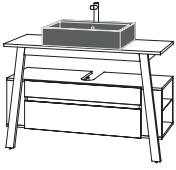

PG1

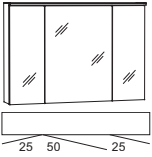
	<p><b>Set 100 cm bestehend aus:</b></p> <p>Aufsatz-Keramik-Waschtisch <b>Rumba</b> Waschtischplatte 19 mm im Dekor <b>Eiche Struktur Natur Nachbildung</b> Waschtischunterschrank, 1 Schubkasten, 1 Auszug, 2 offene Fächer inkl. Glasein- legeboden Tischgestell im Dekor <b>Eiche Struktur Natur Nachbildung</b></p>	100,4	90,9	48,5	GHSA10AM	WT: Weiß Glanz	3763	<p>Waschtischplatte und Tischgestell im Dekor <b>Eiche Struktur Natur Nachbildung</b></p>  <p><b>wb: gloss white</b></p> <p>washbasin plate and table frame in the decor <b>oak structure nature finish</b></p> 
	<p><b>Set 100 cm width consisting of:</b> on-top ceramic washbasin <b>Rumba</b> washbasin plate 19 mm in the decor <b>oak structure nature finish</b> washbasin base cabinet, 1 drawer, 1 extension and 2 open compartments incl. glass shelves table frame in the decor <b>oak structure nature finish</b></p>	61,2	12,0	46,6				
	<p><b>Set 100 cm bestehend aus:</b></p> <p>Aufsatz-Keramik-Waschtisch <b>Rumba</b> Waschtischplatte 19 mm im Dekor <b>Schwarz Supermatt</b> Waschtischunterschrank, 1 Schubkasten, 1 Auszug, 2 offene Fächer inkl. Glasein- legeboden Tischgestell im Dekor <b>Schwarz Supermatt</b></p>	100,4	90,9	48,5	GHSA10AS	WT: Weiß Glanz	4031	<p>Waschtischplatte und Tischgestell im Dekor <b>Schwarz Supermatt</b></p>  <p><b>wb: gloss white</b></p> <p>washbasin plate and table frame in the decor <b>black super matt</b></p> 
	<p><b>Set 100 cm width consisting of:</b> on-top ceramic washbasin <b>Rumba</b> washbasin plate 19 mm in the decor <b>black super matt</b> washbasin base cabinet, 1 drawer, 1 extension and 2 open compartments incl. glass shelves table frame in the decor <b>black super matt</b></p>	61,2	12,0	46,6				
	<p><b>Set 120 cm bestehend aus:</b></p> <p>Aufsatz-Keramik-Waschtisch <b>Rumba</b> Waschtischplatte 19 mm im Dekor <b>Eiche Struktur Natur Nachbildung</b> Waschtischunterschrank, 1 Schubkasten, 1 Auszug, 2 offene Fächer inkl. Glasein- legeboden Tischgestell im Dekor <b>Eiche Struktur Natur Nachbildung</b></p>	120,4	90,9	48,5	GHSA12AM	WT: Weiß Glanz	4009	<p>Waschtischplatte und Tischgestell im Dekor <b>Eiche Struktur Natur Nachbildung</b></p>  <p><b>wb: gloss white</b></p> <p>washbasin plate and table frame in the decor <b>oak structure nature finish</b></p> 
	<p><b>Set 120 cm width consisting of:</b> on-top ceramic washbasin <b>Rumba</b> washbasin plate 19 mm in the decor <b>oak structure nature finish</b> washbasin base cabinet, 1 drawer, 1 extension and 2 open compartments incl. glass shelves table frame in the decor <b>oak structure nature finish</b></p>	61,2	12,0	46,6				
	<p><b>Set 120 cm bestehend aus:</b></p> <p>Aufsatz-Keramik-Waschtisch <b>Rumba</b> Waschtischplatte 19 mm im Dekor <b>Schwarz Supermatt</b> Waschtischunterschrank, 1 Schubkasten, 1 Auszug, 2 offene Fächer inkl. Glasein- legeboden Tischgestell im Dekor <b>Schwarz Supermatt</b></p>	120,4	90,9	48,5	GHSA12AS	WT: Weiß Glanz	4345	<p>Waschtischplatte und Tischgestell im Dekor <b>Schwarz Supermatt</b></p>  <p><b>wb: gloss white</b></p> <p>washbasin plate and table frame in the decor <b>black super matt</b></p> 
	<p><b>Set 120 cm width consisting of:</b> on-top ceramic washbasin <b>Rumba</b> washbasin plate 19 mm in the decor <b>black super matt</b> washbasin base cabinet, 1 drawer, 1 extension and 2 open compartments incl. glass shelves table frame in the decor <b>black super matt</b></p>	61,2	12,0	46,6				

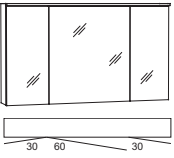
3500maxus »Sets mit Waschtisch Rumba Schwarz Matt/sets with washbasin Rumba matt black«

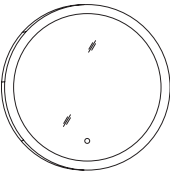

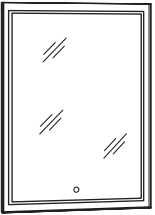
Beschreibung Description	Maße in cm Dimensions in cm			Artikel-Nr. Article no.	Türanschlag Door stop	Identnummer ID number
	B/W	H	T/D			
PG1						
 <p><b>Set 100 cm bestehend aus:</b>                      Aufsatz-Keramik-Waschtisch Rumba                      Waschtischplatte 19 mm im Dekor  <b>Eiche Struktur Natur Nachbildung</b>                      Waschtischunterschrank, 1 Schubkasten,                      1 Auszug, 2 offene Fächer inkl. Glasein-                      legeboden                      Tischgestell im Dekor <b>Eiche Struktur                      Natur Nachbildung</b></p> <p><b>Set 100 cm width consisting of:</b>                      on-top ceramic washbasin <b>Rumba</b>                      washbasin plate 19 mm in the decor  <b>oak structure nature finish</b>                      washbasin base cabinet, 1 drawer,                      1 extension and 2 open compartments                      incl. glass shelves                      table frame in the decor <b>oak structure                      nature finish</b></p>	100,4	90,9	48,5	GHSA10AMS	WT: Schwarz Matt	4031
	61,2	12,0	46,6			
 <p><b>Set 100 cm bestehend aus:</b>                      Aufsatz-Keramik-Waschtisch Rumba                      Waschtischplatte 19 mm im Dekor  <b>Schwarz Supermatt</b>                      Waschtischunterschrank, 1 Schubkasten,                      1 Auszug, 2 offene Fächer inkl. Glasein-                      legeboden                      Tischgestell im Dekor <b>Schwarz Supermatt</b></p> <p><b>Set 100 cm width consisting of:</b>                      on-top ceramic washbasin <b>Rumba</b>                      washbasin plate 19 mm in the decor  <b>black super matt</b>                      washbasin base cabinet, 1 drawer,                      1 extension and 2 open compartments                      incl. glass shelves                      table frame in the decor <b>black super matt</b></p>	100,4	90,9	48,5	GHSA10ASS	WT: Schwarz Matt	4300
	61,2	12,0	46,6			
 <p><b>Set 120 cm bestehend aus:</b>                      Aufsatz-Keramik-Waschtisch Rumba                      Waschtischplatte 19 mm im Dekor  <b>Eiche Struktur Natur Nachbildung</b>                      Waschtischunterschrank, 1 Schubkasten,                      1 Auszug, 2 offene Fächer inkl. Glasein-                      legeboden                      Tischgestell im Dekor <b>Eiche Struktur                      Natur Nachbildung</b></p> <p><b>Set 120 cm width consisting of:</b>                      on-top ceramic washbasin <b>Rumba</b>                      washbasin plate 19 mm in the decor  <b>oak structure nature finish</b>                      washbasin base cabinet, 1 drawer,                      1 extension and 2 open compartments                      incl. glass shelves                      table frame in the decor <b>oak structure                      nature finish</b></p>	120,4	90,9	48,5	GHSA12AMS	WT: Schwarz Matt	4278
	61,2	12,0	46,6			
 <p><b>Set 120 cm bestehend aus:</b>                      Aufsatz-Keramik-Waschtisch Rumba                      Waschtischplatte 19 mm im Dekor  <b>Schwarz Supermatt</b>                      Waschtischunterschrank, 1 Schubkasten,                      1 Auszug, 2 offene Fächer inkl. Glasein-                      legeboden                      Tischgestell im Dekor <b>Schwarz Supermatt</b></p> <p><b>Set 120 cm width consisting of:</b>                      on-top ceramic washbasin <b>Rumba</b>                      washbasin plate 19 mm in the decor  <b>black super matt</b>                      washbasin base cabinet, 1 drawer,                      1 extension and 2 open compartments                      incl. glass shelves                      table frame in the decor <b>black super matt</b></p>	120,4	90,9	48,5	GHSA12ASS	WT: Schwarz Matt	4614
	61,2	12,0	46,6			



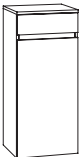

## 3500maxus »Spiegelschränke und Spiegelpaneele/mirror cabinets and mirror panels«

Beschreibung Description	Maße in cm Dimensions in cm			Artikel-Nr. Article no.	Türanschlag Door stop	Identnummer ID number
	B/W	H	T/D			
 <p>Spiegelschrank, 3 Spiegeltüren 6 Glaseinlegeböden, inkl. Schalter/ Steckdose, integrierte LED-Aufbauleuchte, 4000 K, 9,6 W, 1050 Lumen, EEK F</p> <p><i>mirror cabinet, 3 mirror doors 6 glass boards, incl. switch/socket integrated LED-lighting, 4000 K, 9,6 W, 1050 lumen, EEC F</i></p>	100,0	69,6	17,6	<b>SLWB10</b>		<b>1523</b>
Dieses Produkt enthält eine Lichtquelle der Energieeffizienzklasse F						
 <p>Spiegelschrank, 3 Spiegeltüren 6 Glaseinlegeböden, inkl. Schalter/ Steckdose, integrierte LED-Aufbauleuchte, 4000 K, 11,5 W, 1260 Lumen, EEK F</p> <p><i>mirror cabinet, 3 mirror doors 6 glass boards, incl. switch/socket integrated LED-lighting, 4000 K, 11,5 W, 1260 lumen, EEC F</i></p>	120,0	69,6	17,6	<b>SLWB12</b>		<b>1702</b>
Dieses Produkt enthält eine Lichtquelle der Energieeffizienzklasse F						
 <p>Spiegelpaneel, Sensorschalter, satiniert, LED Beleuchtung, 4000 K, 20,8 W, 2905 Lumen, EEK G <b>Helligkeit dimmbar</b></p> <p><i>mirror panel, sensor switch, satined, LED-lighting, 4000 K, 20,8 W, 2905 lumen, EEC G <b>brighness dimmable</b></i></p>	78,0	78,0	2,8	<b>SPK78</b>	 	<b>1292</b>
Dieses Produkt enthält eine Lichtquelle der Energieeffizienzklasse G						
 <p>Spiegelpaneel, Sensorschalter, satiniert, LED Beleuchtung, 4000 K, 24,5 W, 430 Lumen, EEK G <b>Helligkeit dimmbar</b></p> <p><i>mirror panel, sensor switch, satined, LED-lighting, 4000 K, 24,5 W, 430 lumen, EEC G <b>brighness dimmable</b></i></p>	60,0	80,0	2,7	<b>SPLEK6</b>	 	<b>1008</b>
Dieses Produkt enthält eine Lichtquelle der Energieeffizienzklasse G						

EEK/EEC=Energieeffizienzklasse/energy efficiency category  
Leuchtmittel sind nicht austauschbar / illuminants are not interchangeable.

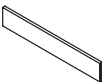
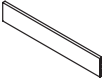
## 3500maxus »Beistellschränke/side cabinets«

						PG1
 <p>Highboard inkl. Abdeckplatte 1 Tür, 1 Schubkasten 2 Glaseinlegeböden</p> <p><i>highboard incl. top 1 door, 1 drawer 2 glass boards</i></p>	40,0	91,2	35,0	<b>GHBST4FL</b> <b>GHBST4FR</b>	Links/ <i>left</i> Rechts/ <i>right</i>	<b>992</b>
 <p>Mittelschrank inkl. Abdeckplatte 2 Türen, 1 Schubkasten 3 Glaseinlegeböden</p> <p><i>medium cabinet incl. top 2 doors, 1 drawer 3 glass boards</i></p>	40,0	148,8	35,0	<b>GMTST4FL</b> <b>GMTST4FR</b>	Links/ <i>left</i> Rechts/ <i>right</i>	<b>1362</b>
 <p>Hochschrank 2 Türen, 1 Schubkasten 3 Glaseinlegeböden</p> <p><i>tower cabinet 2 doors / 1 drawer 3 glass boards</i></p>	40,0	178,7	35,0	<b>GHTST4L</b> <b>GHTST4R</b>	Links/ <i>left</i> Rechts/ <i>right</i>	<b>1546</b>

Beschreibung Description	Maße in cm Dimensions in cm			Artikel-Nr. Article no.	Türanschlag Door stop	Identnummer ID number
	B/W	H	T/D			
 <p>Handtuchhalter 1-armig <b>Schwarz Matt</b> (inkl. Adapter zum <b>unterschrauben</b> an der Waschtischplatte)</p> <p><i>towel rail 1-arm <b>mat black</b> (incl. adapter for <b>mounting</b> under the washbasin plate)</i></p>	5,0	1,0	33,0	<b>HHU133</b>		<b>161</b>
 <p>Inneneinteilung für 70 cm Auszug</p> <p><i>internal partitioning for 70 cm extension</i></p>	68,0	6,0	1,1	<b>IEG70</b>		<b>137</b>
 <p>Inneneinteilung für 90 cm Auszug</p> <p><i>internal partitioning for 90 cm extension</i></p>	88,0	6,0	1,1	<b>IEG90</b>		<b>157</b>
 <p>Schubkasteneinsatz (Kunststoff) für oberen Auszug vom WT-Unterschrank</p> <p><i>drawer insert part (plastic) for top drawer from base cabinet</i></p>	33,7	4,3	33,0	<b>SMBEG3</b>		<b>69</b>
 <p>Steckdose/Powerbox für Spiegelschränke Ausführung Schweiz IP44 mit USB-C Stecker</p> <p><i>Power socket for mirror cabinets Switzerland type IP44 with USB-C plug</i></p>				<b>Mehrpreis extra charge</b>		<b>138</b>
 <p>Steckdose/Powerbox für Spiegelschränke Ausführung Frankreich mit USB-C Stecker</p> <p><i>Power socket for mirror cabinets France type with USB-C plug</i></p>				<b>Mehrpreis extra charge</b>		<b>138</b>

**i** Weiteres Zubehör finden Sie im Register 3970.  
Further accessoires can be found in register 3970.





# 3510clarus

3510





# »3510clarus«

Piktogramme/pictograms



Keramik Waschtisch  
Ceramic washbasin



LED Lichtfarbe warm  
LED colour temperature warm



LED mit Bewegungssensor  
LED with motion sensor

## Keramik Waschtisch weiß alpin Glanz (RTK) Ceramic washbasin gloss alpine white (RTK)

 ≈ Beckenmaße in cm (BxHxT)  
basin dimensions in cm (WxHxD)

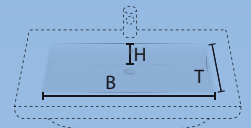

KWRTM8 |  44,0 x 11,5 x 26,0 cm



KWRTM10 |  50,0 x 11,5 x 26,0 cm



KWRTM12D |  41,0 x 11,5 x 26,0 cm

**!** Diese Keramikwaschtische benötigen keine Wandbefestigung.  
These ceramic basins do not require wall mounting.

## Schränke/cabinets 3510clarus

### Frontfarben/front colours

#### Dickkante/thick edge

611



**Weiß Supermatt**  
White Super Matt  
RTP\_

401



**Schwarz Supermatt**  
Black Super Matt  
RTS\_

473



**Eiche Struktur Natur Nachbildung**  
Oak Structure Nature Finish  
RTM\_

435



**Eiche Struktur Weiß Nachbildung**  
Oak Structure White Finish  
RTL\_

426



**Eiche Struktur Braun Nachbildung**  
Oak Structure Brown Finish  
RTH\_

### Korpusfarben/basic shell colours

#### PG 1 Dickkante/thick edge

401



**Schwarz Supermatt**  
Black Super Matt  
S/RT25

### Griffleiste/handle bar



**Schwarz Matt Struktur**  
Matt Black Structure

### Beleuchtung / lighting



**Integrierte Aufbauleuchte LED**  
Integrated top light LED

**Lichtfarbe Wohlfühllicht (Warm)**  
Luminous colour warm light



**Integrierte Unterbauleuchte LED**  
Integrated under-cabinet light LED

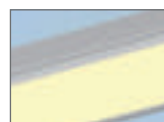

**Lichtfarbe Wohlfühllicht (Warm)**  
Luminous colour warm light



Die Steckdose / Powerbox für Spiegelschränke ist auch in Ausführung für die Schweiz / Frankreich erhältlich. Bitte Mehrpreis beachten (siehe Seite 6).  
The power socket for mirror cabinets is also available for Switzerland / France. Please note extra charge (see page 6).

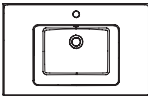

# 3510clarus »80 cm Keramik/ceramic«

Beschreibung Description	Maße in cm Dimensions in cm			Artikel-Nr. Article no.	Türanschlag Door stop	Identnummer ID number
	B/W	H	T/D			

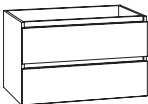

	Keramik-Waschtisch inkl. Überlauf  <i>ceramic washbasin incl. overflow</i>	80,5	1,8	46,0	KWRTM8  	717
---	---	------	-----	------	---	-----

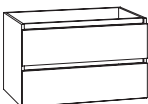
						PG1
--	--	--	--	--	--	-----

	Waschtisch-Unterschrank 1 Schubkasten, 1 Auszug  <i>washbasin base cabinet 1 drawer, 1 extension</i>	80,0	47,8	46,0	BWKDSA8	1725
---	---	------	------	------	---------	------

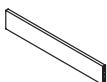

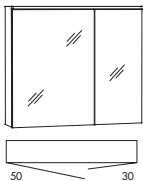



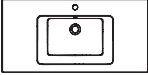

	Waschtisch-Unterschrank 1 Schubkasten, 1 Auszug <b>mit LED-Beleuchtung und Bewegungs- sensor, 4000 K, 3,6 W, 264 Lumen, EEK F</b>  <i>washbasin base cabinet 1 drawer, 1 extension <b>with LED-lighting and motion sensor 4000 K, 3,6 W, 264 lumen, EEC F</b></i>	80,0	47,8	46,0	   Dieses Produkt enthält eine Lichtquelle der Energieeffizienzklasse F	2419
---	---	------	------	------	---	------

	Inneneinteilung für 80 cm Auszug  <i>internal partitioning for 80 cm extension</i>	78,0	6,0	1,1	IEG80	148
---	---	------	-----	-----	-------	-----

	Spiegelschrank, 2 beidseitig verspiegelte Türen, 2 Glaseinlegeböden, inkl. Schalter/ Steckdose, integrierte LED-Aufbauleuchte, 4000 K, 7,7 W, 840 Lumen, EEK F und integrierte LED-Unterbauleuchte zur Waschtischausleuchtung, 4000 K, 7,5 W, 1050 Lumen, EEK F  <i>mirror cabinet, 2 doors mirrored on both sides, 2 glass boards, incl. switch/socket integrated LED-lighting, 4000 K, 7,7 W, 840 lumen, EEC F and integrated under-cabinet luminaire for washbasin illumination, 4000 K, 7,5 W, 1050 lumen, EEC F</i>	80,0	69,6	17,6	SLWA8L    Dieses Produkt enthält Licht- quellen der Energieeffizienzklasse F	1635
---	--	------	------	------	---	------

EEK/EEC=Energieeffizienzklasse/energy efficiency category  
Leuchtmittel sind nicht austauschbar / illuminants are not interchangeable.

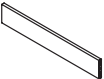
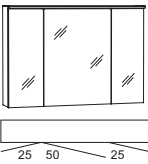





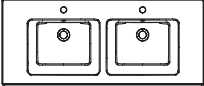

# 3510clarus »100 cm Keramik/ceramic«

Beschreibung Description	Maße in cm Dimensions in cm			Artikel-Nr. Article no.	Türanschlag Door stop	Identnummer ID number
	B/W	H	T/D			
 <p>Keramik-Waschtisch inkl. Überlauf</p> <p><i>ceramic washbasin incl. overflow</i></p>	101,5	1,8	46,0	<b>KWRM10</b>		<b>896</b>
						PG1
 <p>Waschtisch-Unterschrank 1 Schubkasten, 1 Auszug</p> <p><i>washbasin base cabinet 1 drawer, 1 extension</i></p>	100,0	47,8	46,0	<b>BWKDSA10</b>		<b>1904</b>
 <p>Waschtisch-Unterschrank 1 Schubkasten, 1 Auszug <b>mit LED-Beleuchtung und Bewegungs- sensor, 4000 K, 4,6 W, 334 Lumen, EEK F</b></p> <p><i>washbasin base cabinet 1 drawer, 1 extension <b>with LED-lighting and motion sensor 4000 K, 4,6 W, 334 lumen, EEC F</b></i></p>	100,0	47,8	46,0	<b>BWKDSAL10</b>	  <p>Dieses Produkt enthält eine Lichtquelle der Energieeffizienzklasse F</p>	<b>2688</b>
 <p>Inneneinteilung für 100 cm Auszug</p> <p><i>internal partitioning for 100 cm extension</i></p>	98,0	6,0	1,1	<b>IEG100</b>		<b>171</b>
 <p>Spiegelschrank, 3 Spiegeltüren 6 Glaseinlegeböden, inkl. Schalter/ Steckdose, integrierte LED-Aufbauleuchte, 4000 K, 9,6 W, 1050 Lumen, EEK F und integrierte LED-Unterbauleuchte zur Waschtischausleuchtung, 4000 K, 9,5 W, 1330 Lumen, EEK F</p> <p><i>mirror cabinet, 3 mirror doors 6 glass boards, incl. switch/socket integrated LED-lighting, 4000 K, 9,6 W, 1050 lumen, EEC F and integrated under-cabinet luminaire for washbasin illumination, 4000 K, 9,5 W, 1330 lumen, EEC F</i></p>	100,0	69,6	17,6	<b>SLWA10</b>	 <p>Dieses Produkt enthält Licht- quellen der Energieeffizienzklasse F</p>	<b>1792</b>

EEK/EEC=Energieeffizienzklasse/energy efficiency category  
Leuchtmittel sind nicht austauschbar / illuminants are not interchangeable.

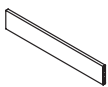
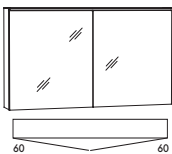

# 3510clarus »120 cm Keramik/ceramic«

Beschreibung Description	Maße in cm Dimensions in cm			Artikel-Nr. Article no.	Türanschlag Door stop	Identnummer ID number
	B/W	H	T/D			



	<p>Keramik-Waschtisch inkl. Überlauf</p> <p><i>ceramic washbasin incl. overflow</i></p>	121,5	1,8	46,0	<p>KWRM12D</p> 	1165
						PG1
	<p>Waschtisch-Unterschrank 1 Schubkasten, 1 Auszug</p> <p><i>washbasin base cabinet 1 drawer, 1 extension</i></p>	120,0	47,8	46,0	<p>BWKDSA12</p>	2061
	<p>Waschtisch-Unterschrank 1 Schubkasten, 1 Auszug <b>mit LED-Beleuchtung und Bewegungs- sensor, 4000 K, 5,5 W, 404 Lumen, EEK F</b></p> <p><i>washbasin base cabinet 1 drawer, 1 extension <b>with LED-lighting and motion sensor 4000 K, 5,5 W, 404 lumen, EEC F</b></i></p>	120,0	47,8	46,0	<p>BWKDSAL12</p>   <p>Dieses Produkt enthält eine Lichtquelle der Energieeffizienzklasse F</p>	2912
	<p>Inneneinteilung für 120 cm Auszug</p> <p><i>internal partitioning for 120 cm extension</i></p>	118,0	6,0	1,1	<p>IEG120</p>	199
	<p>Spiegelschrank, 2 beidseitig verspiegelte Türen, 4 Glaseinlegeböden, inkl. Schalter/ Steckdose, integrierte LED-Aufbauleuchte, 4000 K, 11,5 W, 1260 Lumen, EEK F und integrierte LED-Unterbauleuchte zur Waschtischausleuchtung, 4000 K, 11,5 W, 1610 Lumen, EEK F</p> <p><i>mirror cabinet, 2 doors mirrored on both sides, 4 glass boards, incl. switch/socket integrated LED-lighting, 4000 K, 11,5 W, 1260 lumen, EEC F and integrated under-cabinet luminaire for washbasin illumination, 4000 K, 11,5 W, 1610 lumen, EEC F</i></p>	120,0	69,6	17,6	<p>SLWA12D</p>  <p>Dieses Produkt enthält Licht- quellen der Energieeffizienzklasse F</p>	2128

EEK/EEC=Energieeffizienzklasse/energy efficiency category  
Leuchtmittel sind nicht austauschbar / illuminants are not interchangeable.

## 3510clarus »Beistellschränke/side cabinets«

Beschreibung Description	Maße in cm Dimensions in cm			Artikel-Nr. Article no.	Türanschlag Door stop	Identnummer ID number
	B/W	H	T/D			
 Highboard inkl. Abdeckplatte 1 Tür, 1 Schubkasten 2 Glaseinlegeböden  <i>highboard incl. top 1 door, 1 drawer 2 glass boards</i>	40,0	91,2	35,0	<b>BHBST4FL</b> <b>BHBST4FR</b>	Links/ <i>left</i> Rechts/ <i>right</i>	PG1 <b>1165</b>
 Mittelschrank inkl. Abdeckplatte 2 Türen, 1 Schubkasten 3 Glaseinlegeböden  <i>medium cabinet incl. top 2 doors, 1 drawer 3 glass boards</i>	40,0	148,8	35,0	<b>BMTST4FL</b> <b>BMTST4FR</b>	Links/ <i>left</i> Rechts/ <i>right</i>	<b>1702</b>
 Hochschrank 2 Türen, 1 Schubkasten 3 Glaseinlegeböden  <i>tower cabinet 2 doors / 1 drawer 3 glass boards</i>	40,0	178,7	35,0	<b>BHTST4L</b> <b>BHTST4R</b>	Links/ <i>left</i> Rechts/ <i>right</i>	<b>1792</b>

## 3510clarus »Zubehör/accessoires«

Beschreibung Description	Maße in cm Dimensions in cm			Artikel-Nr. Article no.	Türanschlag Door stop	Identnummer ID number
	B/W	H	T/D			
 Schubkasteneinsatz (Kunststoff) für oberen Auszug vom WT-Unterschrank  <i>drawer insert part (plastic) for top drawer from base cabinet</i>	33,7	4,3	33,0	<b>SMBEG3</b>		<b>69</b>
 Steckdose/Powerbox für Spiegelschränke Ausführung Schweiz IP44 mit USB-C Stecker  <i>Power socket for mirror cabinets Switzerland type IP44 with USB-C plug</i>				<b>Mehrpreis extra charge</b>		<b>138</b>
 Steckdose/Powerbox für Spiegelschränke Ausführung Frankreich mit USB-C Stecker  <i>Power socket for mirror cabinets France type with USB-C plug</i>				<b>Mehrpreis extra charge</b>		<b>138</b>

**i** Weiteres Zubehör finden Sie im Register 3970.  
*Further accessoires can be found in register 3970.*



Wichtige Änderungen / Important changes



**Beistellschränke** und **Zubehör**  
finden Sie ab sofort in den Rubriken

**3990beistellschränke**

**3970zubehör**

**Montageskizzen** finden Sie ausschließlich  
im Internet unter **www.marlinbad.de**

*From now on you will find **side cabinets** and  
**accessories** in their respective categories*

**3990beistellschränke**

**3970zubehör**

**Assembly sketches** can be downloaded  
on our website **www.marlinbad.de**



# GÄSTEBÄDER GUEST BATHROOM







# 3010guest





# 3010guest



# »3010guest«

## Piktogramme/pictograms



Mineralmarmor Waschtisch  
Marble minerals washbasin



LED Lichtfarbe kalt  
LED colour temperature cold



LED mit Bewegungssensor  
LED with motion sensor



Glas Waschtisch  
Glass washbasin



LED Lichtfarbe warm  
LED colour temperature warm



LED mit Sensorschalter  
LED with sensor switch

## Mineralmarmor Waschtisch weiß alpin Glanz (GB69) Marble minerals washbasin gloss alpine white (GB69)

≈ Beckenmaße in cm (BxHxT)  
basin dimensions in cm (WxHxD)

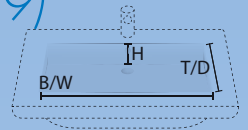

3010.1

MWGBS5 | 32,5 x 10 x 23 cm

## Glas Waschtisch weiß Glanz (GB79) Glass washbasin gloss white (GB79)



3010.1

GWGBS5 | 33 x 10 x 22 cm  
Glasbecken links und rechts möglich. *Glass-basin left and right possible.*

## Mineralmarmor Waschtisch weiß alpin Glanz (GB69) Marble minerals washbasin gloss alpine white (GB69)



3010.2

MWGB06 | 54 x 10 x 21 cm

# »3010guest«

## Mineralmarmor Waschtisch weiß alpin Glanz (GB69)

Marble minerals washbasin gloss alpine white (GB69)

 ≈ Beckenmaße in cm (BxHxT)  
basin dimensions in cm (WxHxD)

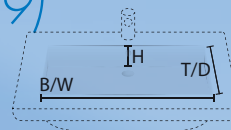

3010.3

MWGBS7 |  11 cm hoch/high





Detail

## Mineralmarmor Waschtisch weiß alpin Glanz (GB69)

Marble minerals washbasin gloss alpine white (GB69)



3010.4

MWSTA6R |  38 x 10 x 24 cm  
MWSTAL6R |  38 x 10 x 24 cm\*

NEW



(L) mit LED-Beleuchtung  
(L) with LED-lighting



Detail

## Mineralmarmor Waschtisch weiß alpin Glanz (GB69)

Marble minerals washbasin gloss alpine white (GB69)



3010.5

MWGBA6 |  35,7 x 10 x 30 cm



Detail

## Glas Waschtisch weiß Glanz (GB79)

Glass washbasin gloss white (GB79)



3010.6

GWGB05 |  33 x 11 x 26,5 cm  
Glasbecken links und rechts möglich. *Glas-basin left and right possible.*



Detail



# »3010guest«

## Mineralmarmor Waschtisch weiß alpin Glanz (GB69) Marble minerals washbasin gloss alpine white (GB69)

 ≈ Beckenmaße in cm (BxHxT)  
basin dimensions in cm (WxHxD)

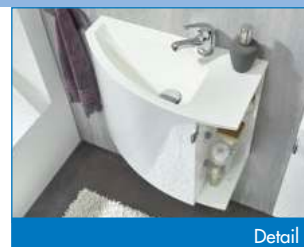
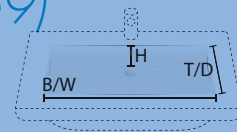

Detail

3010.7

MWGGB6 |  13 cm hoch/high

## Mineralmarmor Waschtisch weiß alpin Glanz (GB69) Marble minerals washbasin gloss alpine white (GB69)



Detail

3010.8

MWGBC6 |  Ø 23,5 cm x 10,9 cm hoch/high

## Mineralmarmor Waschtisch weiß alpin Glanz (GB69) Marble minerals washbasin gloss alpine white (GB69)



Detail

3010.9

MWGBD6 |  38 x 22 x 10,6 cm

## Schränke/cabinets

### Frontfarben/front colours

3010. 1, 2, 3, 5, 6, 7 guest

#### MDF-foliert/MDF-coated

273



**Eiche Struktur Natur Nachbildung**  
Oak Structure Nature Finish  
GBM\_

961



**Weiß Glanz**  
Gloss White  
GBG\_

226



**Eiche Struktur Braun Nachbildung** NEW  
Oak Structure Brown Finish  
GBH\_

438



**Anthrazit Glanz**  
Gloss Anthracite  
GBF\_

### Korpusfarben/basic shell colours

3010. 1, 2, 3, 5, 6 guest

#### PG 2 Dickkante/thick edge

473



**Eiche Struktur Natur Nachbildung**  
Oak Structure Nature Finish  
M/GB55

042



**Weiß Glanz Folie**  
Gloss White  
G/GB50

426



**Eiche Struktur Braun Nachbildung** NEW  
Oak Structure Brown Finish  
H/GB70

438



**Anthrazit Glanz Folie**  
Gloss Anthracite  
F/GB30

#### PG 3 MDF-foliert/MDF-coated

### Korpusfarben/basic shell colours

3010.7 guest

#### PG 2 Dickkante/thick edge

473



**Eiche Struktur Natur Nachbildung**  
Oak Structure Nature Finish  
M/GB55

286



**Weiß Seidenglanz**  
Silk Gloss White  
E/GB86

426



**Eiche Struktur Braun Nachbildung** NEW  
Oak Structure Brown Finish  
H/GB70

284



**Anthrazit Seidenglanz**  
Silk Gloss Anthracite  
A/GB84

## Schränke/cabinets

Frontfarben/front colours

3010. 4, 8, 9 guest

Dickkante/thick edge

473



**Eiche Struktur Natur Nachbildung**

*Oak Structure Nature Finish*

GBL\_

286



**Weiß Seidenglanz**

*Silk Gloss White*

GBE\_

426



**Eiche Struktur Braun Nachbildung** NEW

*Oak Structure Brown Finish*

GBX\_

284



**Anthrazit Seidenglanz**

*Silk Gloss Anthracite*

GBA\_

Korpusfarben/basic shell colours

3010. 4, 8, 9 guest

PG 1 Dickkante/thick edge

473



**Eiche Struktur Natur Nachbildung**

*Oak Structure Nature Finish*

M/GB55

286



**Weiß Seidenglanz**

*Silk Gloss White*

E/GB86

426



**Eiche Struktur Braun Nachbildung** NEW

*Oak Structure Brown Finish*

H/GB70

284



**Anthrazit Seidenglanz**

*Silk Gloss Anthracite*

A/GB84

## Regalfarben/ shelf colours

287



**Weiß Seidenglanz**  
Silk Gloss White  
GB86

285



**Anthrazit Seidenglanz**  
Silk Gloss Anthracite  
GB84

474



**Eiche Struktur Nachbildung**  
Oak Structure Finish  
GB55

427



**Eiche Struktur Braun Nachbildung** NEW  
Oak Structure Brown Finish  
H/GB70

## Griffe/handles

3010. 1, 6



**Chrom Glanz**  
Gloss Chrome  
173  
⌀—⌀ 320 mm

3010.2



**Chrom Glanz**  
Gloss Chrome  
330  
⌀—⌀ 16 mm

3010. 4



**Chrom Glanz**  
Gloss Chrome  
384  
⌀—⌀ 184 mm

3010. 3, 5, 7, 8, 9



**Chrom Glanz**  
Gloss Chrome  
329  
⌀—⌀ 20 mm

⌀—⌀ = Bohrabstand/ hole spacing

3010. 8, 9







„Push-to-open“ möglich  
„Push-to-open“ possible

## Armatur/amature

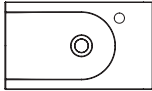
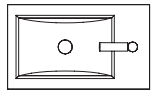



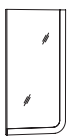

**MBCAP**  
Einhebel-Waschtischarmatur chrom inkl.  
Zugstange und Befestigungsmaterial

single lever top, chrome incl. eccentric  
tappet and fastening materials

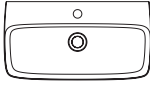
Beschreibung Description	Maße in cm Dimensions in cm			Artikel-Nr. Article no.	Türanschlag Door stop	Identnummer ID number	
	B/W	H	T/D				
 <p><b>Mineralmarmor-Waschtisch</b> Ablage rechts inkl. Permanentablauf</p> <p><i>marble minerals washbasin</i> <i>depot on the right</i> <i>incl. permanent drain valve</i></p>	50,4	2,0	30,0	MWGBS5		670	
 <p><b>Glas-Waschtisch</b> Becken links und rechts möglich inkl. Permanentablauf</p> <p><i>glass washbasin</i> <i>basin left and right possible</i> <i>incl. permanent drain valve</i></p>	50,4	1,2	30,0	GWGBS5		670	
 <p>Raumsparisiphon</p> <p><i>basin siphon</i></p>				RSS		134	
 <p>Einhebel-Waschtischarmatur chrom inkl. Zugstange und Befestigungsmaterial</p> <p><i>single lever tap, chrome</i> <i>incl. eccentric tappet and fastening materials</i></p>				MBCAP		208	
						PG2	PG3
 <p>Waschtisch-Unterschrank 1 Klappe, 1 offenes Fach</p> <p><i>washbasin base cabinet</i> <i>1 flap door, 1 open case</i></p>	50,0	47,8	29,8	WMJK5		808	1022
 <p>Spiegelpaneel LED Beleuchtung, satiniert 6000 K, 10,75 W, 1161 Lumen, EEK</p> <p><i>mirror panel</i> <i>LED-lighting, satined</i> <i>6000 K, 10,75 W, 1161 lumen, EEC</i></p>	40,0	80,0	2,5	SPLEA4		751	
						PG2	PG3
 <p>Mittelschrank 1 Tür, 1 offenes Fach, 2 Glaseinlegeböden, <b>nur Anschlag rechts möglich</b></p> <p><i>medium cabinet</i> <i>1 door, 1 open case, 2 glass boards</i> <b>only door stop right possible</b></p>	20,0	147,0	17,5	MT2	Rechts/right	785	992

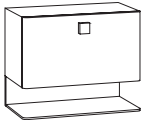

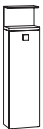
EEK/EEC=Energieeffizienzklasse/energy efficiency category  
Leuchtmittel sind nicht austauschbar / illuminants are not interchangeable.

Beschreibung Description	Maße in cm Dimensions in cm			Artikel-Nr. Article no.	Türanschlag Door stop	Identnummer ID number		
	B/W	H	T/D			PG2	PG3	
 <p>Mineralmarmor-Waschtisch inkl. Permanentablauf</p> <p><i>marble minerals washbasin incl. permanent drain valve</i></p>	60,1	9,0	32,0	MWGBO6			808	
 <p>Raumsparophon</p> <p><i>basin siphon</i></p>				RSS			134	
 <p>Einhebel-Waschtischarmatur chrom inkl. Zugstange und Befestigungsmaterial</p> <p><i>single lever tap, chrome incl. eccentric tappet and fastening materials</i></p>				MBCAP			208	
 <p>Waschtisch-Unterschrank 1 Klappe, 1 offenes Fach</p> <p><i>washbasin base cabinet 1 flap door, 1 open case</i></p>	56,0	47,8	29,9	WMMK6			739	923
 <p>Spiegelpaneel LED Beleuchtung, satiniert 6000 K, 24,0 W, 2592 Lumen, EEK</p> <p><i>mirror panel LED-lighting, satined 6000 K, 24,0 W, 2592 lumen, EEC</i></p>	57,0	90,0	2,5	SPLB5				854
 <p>Highboard mit Glasablage 1 Tür, 1 offenes Fach, 2 Glaseinlegeböden</p> <p><i>high board 1 door, 1 open case, 2 glass boards</i></p>	30,0	110,9	18,1	HBRT3LG HBRT3RG	Links/left Rechts/right		577	808

EEK/EEC=Energieeffizienzklasse/energy efficiency category

Leuchtmittel sind nicht austauschbar / illuminants are not interchangeable.

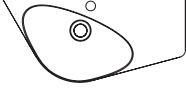

Beschreibung Description	Maße in cm Dimensions in cm			Artikel-Nr. Article no.	Türanschlag Door stop	Identnummer ID number
	B/W	H	T/D			

	Mineralmarmor-Waschtisch Ablage rechts inkl. Permanentablauf	65,0	2,0/ 12,0	32,5	MWGBS7		785
	<i>marble minerals washbasin depot on the right incl. permanent drain valve</i>						

	Raumsparsiphon				RSPAR-4		109
	basin siphon						

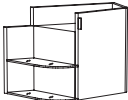







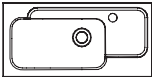

	Einhebel-Waschtischarmatur chrom inkl. Zugstange und Befestigungsmaterial				MBCAP		208
	<i>single lever tap, chrome incl. eccentric tappet and fastening materials</i>						

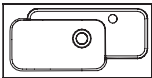
							PG2	PG3
	Waschtisch-Unterschrank 1 Tür, 1 offenes Fach mit 2 Glasablagen	65,0	47,8	32,5	WMNT7		808	946
	<i>washbasin base cabinet 1 door, 1 open case with 2 glass shelves</i>							

	Spiegelpanel LED Beleuchtung, satiniert 6000 K, 19,0 W, 2079 Lumen, EEK	53,0	88,0	2,5	SPLEC5		811
	<i>mirror panel LED-lighting, satined 6000 K, 19,0 W, 2079 lumen, EEC</i>						

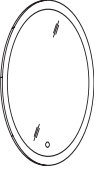
							PG2	PG3
	Mittelschrank 1 Tür, 1 offenes Fach mit 2 Glasablagen 2 Glaseinlegeböden	40,0	147,0	15,6	MRRT4L MRRT4R	Links/left Rechts/right	1200	1384
	<i>medium cabinet 1 door, 1 open case with 2 glass shelves 2 glass boards</i>							





EEK/EEC=Energieeffizienzklasse/energy efficiency category  
Leuchtmittel sind nicht austauschbar / illuminants are not interchangeable.

Beschreibung Description	Maße in cm Dimensions in cm			Artikel-Nr. Article no.	Türanschlag Door stop	Identnummer ID number
	B/W	H	T/D			
 <p>Mineralmarmor-Waschtisch <b>Ablage rechts</b> inkl. Permanentablauf</p> <p><i>marble minerals washbasin depot on the right incl. permanent drain valve</i></p>	60,5	2,0	30,0	<b>MWSTA6R</b>		<b>692</b>
						
 <p>Mineralmarmor-Waschtisch <b>Ablage rechts, inkl. Permanentablauf mit LED-Beleuchtung und Bewegungssensor, 6000 K, 5,3 W, 413 Lumen, EEK G</b></p> <p><i>marble minerals washbasin depot on the right, incl. permanent drain valve with LED-lighting and motion sensor 6000 K, 5,3 W, 413 lumen, EEC G</i></p>	60,5	3,4	30,0	<b>MWSTAL6R</b>		<b>1085</b>
   <p>Dieses Produkt enthält eine Lichtquelle der Energieeffizienzklasse G</p>						
						PG1
 <p>Waschtisch-Unterschrank 2 Türen</p> <p><i>washbasin base cabinet 2 doors</i></p>	60,0	47,8	29,5	<b>WMKT6</b>		<b>624</b>
 <p>Spiegelpaneel, Sensorschalter, satiniert, LED Beleuchtung, 4000 K, 17,3 W, 2415 Lumen, EEK G <b>Helligkeit dimmbar</b></p> <p><i>mirror panel, sensor switch, satined, LED-lighting, 4000 K, 17,3 W, 2415 lumen, EEC G brighness dimmable</i></p>	55,0	78,0	2,8	<b>SPE55</b>		<b>1131</b>
					  <p>Dieses Produkt enthält eine Lichtquelle der Energieeffizienzklasse G</p>	
 <p>Highboard inkl. Abdeckplatte 1 Tür 2 Glaseinlegeböden <b>Griff senkrecht</b></p> <p><i>high cabinet incl. top 1 door 2 glass shelves handle vertical</i></p>	30,0	91,2	17,6	<b>HBFT3FL</b> <b>HBFT3FR</b>	Links/ <i>left</i> Rechts/ <i>right</i>	<b>600</b>
 <p>Highboard inkl. Abdeckplatte 1 Tür 2 Glaseinlegeböden <b>Griff senkrecht</b></p> <p><i>high cabinet incl. top 1 door 2 glass shelves handle vertical</i></p>	40,0	91,2	17,6	<b>HBFT4FL</b> <b>HBFT4FR</b>	Links/ <i>left</i> Rechts/ <i>right</i>	<b>646</b>



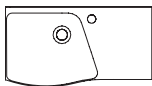

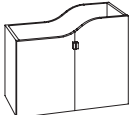
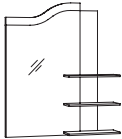

EEK/EEC=Energieeffizienzklasse/energy efficiency category

Leuchtmittel sind nicht austauschbar / illuminants are not interchangeable.

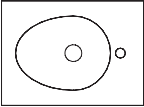



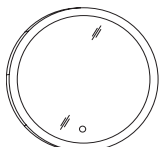





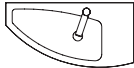

Beschreibung Description	Maße in cm Dimensions in cm			Artikel-Nr. Article no.	Türanschlag Door stop	Identnummer ID number	
	B/W	H	T/D			PG2	PG3
 <p>Mineralmarmor-Waschtisch Ablage rechts inkl. Permanentablauf</p> <p><i>marble minerals washbasin depot on the right incl. permanent drain valve</i></p>	60,4	2,0/ 10,0	33,0	<b>MWGBA6</b>			<b>1061</b>
 <p>Raumsparsiphon</p> <p><i>basin siphon</i></p>				<b>RSS</b>			<b>134</b>
 <p>Einhebel-Waschtischarmatur chrom inkl. Zugstange und Befestigungsmaterial</p> <p><i>single lever tap, chrome incl. eccentric tappet and fastening materials</i></p>				<b>MBCAP</b>			<b>208</b>
						<b>PG2</b>	<b>PG3</b>
 <p>Waschtisch-Unterschrank 2 Türen</p> <p><i>washbasin base cabinet 2 doors</i></p>	60,0	34,9/ 42,9	29,9	<b>WMMT6</b>		<b>686</b>	<b>870</b>
 <p>Spiegelpaneel mit 3 Glasablagen rechts LED Beleuchtung, satiniert 6000 K, 3,6 W, 270 Lumen, EEK G</p> <p><i>mirror panel with 3 glass shelves right LED-lighting, satined 6000 K, 3,6 W, 270 lumen, EEC G</i></p>	59,0	62,0/ 70,0	1,9/ 9,9	<b>SPRA6</b>			<b>855</b>
						<b>PG2</b>	<b>PG3</b>
 <p>Highboard inkl. Abdeckplatte 1 Tür 2 Glaseinlegeböden</p> <p><i>high cabinet incl. top 1 door 2 glass shelves</i></p>	30,0	91,2	17,6	<b>HBFT3FL</b> <b>HBFT3FR</b>	Links/ <i>left</i> Rechts/ <i>right</i>	<b>692</b>	<b>946</b>
 <p>Highboard inkl. Abdeckplatte 1 Tür 2 Glaseinlegeböden</p> <p><i>high cabinet incl. top 1 door 2 glass shelves</i></p>	40,0	91,2	17,6	<b>HBFT4FL</b> <b>HBFT4FR</b>	Links/ <i>left</i> Rechts/ <i>right</i>	<b>785</b>	<b>1038</b>

EEK/EEC=Energieeffizienzklasse/energy efficiency category  
Leuchtmittel sind nicht austauschbar / illuminants are not interchangeable.

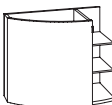
Beschreibung Description	Maße in cm Dimensions in cm			Artikel-Nr. Article no.	Türanschlag Door stop	Identnummer ID number	
	B/W	H	T/D			PG2	PG3
 <p><b>Glas-Waschtisch</b> Becken links und rechts möglich inkl. Permanentablauf</p> <p><b>glass washbasin</b> basin left and right possible incl. permanent drain valve</p>	50,4	1,2	37,1	<b>GWGB05</b>			<b>808</b>
 <p>Raumsparsiphon <i>basin siphon</i></p>				<b>RSS</b>			<b>134</b>
 <p>Einhebel-Waschtischarmatur chrom inkl. Zugstange und Befestigungsmaterial</p> <p><i>single lever tap, chrome incl. eccentric tappet and fastening materials</i></p>				<b>MBCAP</b>			<b>208</b>
						<b>PG2</b>	<b>PG3</b>
 <p>Waschtisch-Unterschrank 1 Auszug</p> <p><i>washbasin base cabinet 1 extension</i></p>	50,0	31,6	36,5	<b>WGGAS</b>			<b>790</b> <b>960</b>
 <p>Spiegelpaneel LED Beleuchtung, satiniert 6000 K, 19,0 W, 2079 Lumen, EEK</p> <p><i>mirror panel LED-lighting, satined 6000 K, 19,0 W, 2079 lumen, EEC</i></p>	53,0	88,0	2,5	<b>SPLEC5</b>			<b>811</b>
 <p>Spiegelpaneel, Sensorschalter, satiniert, LED Beleuchtung, 4000 K, 13,5 W, 1890 Lumen, EEK G <b>Helligkeit dimmbar</b></p> <p><i>mirror panel, sensor switch, satined, LED-lighting, 4000 K, 13,5 W, 1890 lumen, EEC G brighness dimmable</i></p>	55,0	55,0	2,8	<b>SPK55</b>			<b>992</b>
						<b>PG2</b>	<b>PG3</b>
 <p>Highboard inkl. Abdeckplatte 1 Tür 2 Glaseinlegeböden <b>Griff senkrecht</b></p> <p><i>high cabinet incl. top 1 door 2 glass shelves handle vertical</i></p>	30,0	91,2	17,6	<b>HBFT3FL</b> <b>HBFT3FR</b>	Links/left Rechts/right		<b>692</b> <b>946</b>
 <p>Highboard inkl. Abdeckplatte 1 Tür 2 Glaseinlegeböden <b>Griff senkrecht</b></p> <p><i>high cabinet incl. top 1 door 2 glass shelves handle vertical</i></p>	40,0	91,2	17,6	<b>HBFT4FL</b> <b>HBFT4FR</b>	Links/left Rechts/right		<b>785</b> <b>1038</b>









EEK/EEC=Energieeffizienzklasse/energy efficiency category

Leuchtmittel sind nicht austauschbar / illuminants are not interchangeable.

	Beschreibung Description	Maße in cm Dimensions in cm			Artikel-Nr. Article no.	Türanschlag Door stop	Identnummer ID number
		B/W	H	T/D			
	Mineralmarmor-Waschtisch Ablage rechts inkl. Permanentablauf  marble minerals washbasin depot on the right incl. permanent drain valve	60,0	14,0	10,5/ 30,1	MWGBB6  		646
	Raumsparsiphon  basin siphon				RSPAR-4		109
	Einhebel-Waschtischarmatur chrom inkl. Zugstange und Befestigungsmaterial  single lever tap, chrome incl. eccentric tappet and fastening materials				MBCAP		208
							PG2
	Waschtisch-Unterschrank 1 Tür, 1 Regal mit 3 Böden  washbasin base cabinet 1 door, 1 shelf with 3 boards	60,0	47,8	30,0	WMMTR6		951
	Spiegelpaneel LED Beleuchtung, satiniert 4000 K, 10,5 W, 1470 Lumen, EEK G  mirror panel LED-lighting, satined 4000 K, 10,5 W, 1470 lumen, EEC G	45,0	68,2	2,0	SPLEI45  		634
							PG2
	Highboard inkl. Abdeckplatte mit Regal 1 Tür, 1 Glaseinlegeboden Regal mit 3 Glasablagen  high cabinet incl. top with glass shelf 1 door, 1 glass board shelf with 3 glass boards	30,0	95,6	10,5/ 18,6	HBRG3L  Links/left		1016
	Highboard inkl. Abdeckplatte mit Regal 1 Tür, 1 Glaseinlegeboden Regal mit 3 Glasablagen  high cabinet incl. top with glass shelf 1 door, 1 glass board shelf with 3 glass boards	30,0	95,6	10,5/ 18,6	HBRG3R  Rechts/right		1016
	Regal für seitliche Montage oder frei- hängend, inkl. Aufhänger 3 feste Einlegeböden  shelf for side mounting or free-hanging incl. hanging brackets 3 fixed shelves	15,0	68,2	11,6	REA15		345

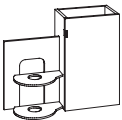
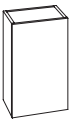
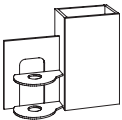
EEK/EEC=Energieeffizienzklasse/energy efficiency category  
Leuchtmittel sind nicht austauschbar / illuminants are not interchangeable.









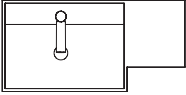

 Regalfarben unbedingt mit angeben, Übersicht siehe Seite 8. Please indicate shelf colours, overview see page 8.

	Beschreibung Description	Maße in cm Dimensions in cm			Artikel-Nr. Article no.	Türanschlag Door stop	Identnummer ID number
		B/W	H	T/D			
	Mineralmarmor-Waschtisch Ablage rechts inkl. Permanentablauf  <i>marble minerals washbasin depot on the right incl. permanent drain valve</i>	60,0	1,2/ 12,4	30,0 20,0	MWGBC6  		992
	Designsiphon  <i>design siphon</i>				DS		249
	Einhebel-Waschtischarmatur chrom inkl. Zugstange und Befestigungsmaterial  <i>single lever tap, chrome incl. eccentric tappet and fastening materials</i>				MBCAP		208
							PG1
	Waschtisch-Unterschrank <b>mit Griff</b> 1 Tür, 1 Glaseinlegeboden  <i>washbasin base cabinet with handle 1 door, 1 glass board</i>	30,0	47,8	20,5	WMMT3	Rechts/ <i>right</i>	420
	Waschtisch-Unterschrank <b>mit Griff</b> 1 Tür, 1 Glaseinlegeboden, 1 Waschtischunterschrank-Regal mit 2 Acrylglasböden  <i>washbasin base cabinet with handle 1 door, 1 glass board 1 washbasin base cabinet-shelf with 2 acryl glass boards</i>	60,0	47,8	20,5	WMMGT6	Rechts/ <i>right</i>	715
	Waschtisch-Unterschrank <b>push to open</b> 1 Tür, 1 Glaseinlegeboden  <i>washbasin base cabinet push to open 1 door, 1 glass board</i>	30,0	47,8	20,5	WMMT3P	Rechts/ <i>right</i>	420
	Waschtisch-Unterschrank <b>push to open</b> 1 Tür, 1 Glaseinlegeboden, 1 Waschtischunterschrank-Regal mit 2 Acrylglasböden  <i>washbasin base cabinet push to open 1 door, 1 glass board 1 washbasin base cabinet-shelf with 2 acryl glass boards</i>	60,0	47,8	20,5	WMMGT6P	Rechts/ <i>right</i>	715
	Spiegelpaneel LED Beleuchtung, satiniert 4000 K, 20,25 W, 2835 Lumen, EEK G  <i>mirror panel LED-lighting, satined 4000 K, 20,25 W, 2835 lumen, EEK G</i>	45,0	80,0	2,0	SPLEJ45  		845
	Regal für seitliche Montage oder frei- hängend, inkl. Aufhänger  <i>shelf for side mounting or free-hanging incl. hanging brackets</i>	15,0	80,0	11,6	REAM15		434
	Regal freihängend inkl. Aufhänger  <i>shelf free-hanging incl. hanging brackets</i>	30,0	47,8	11,6	REAK30		383



EEK/EEC=Energieeffizienzklasse/energy efficiency category



Leuchtmittel sind nicht austauschbar / illuminants are not interchangeable.

 Regalfarben unbedingt mit angeben, Übersicht siehe Seite 8. Please indicate shelf colours, overview see page 8.

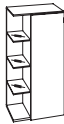
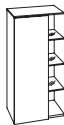
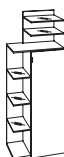
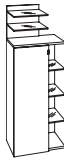
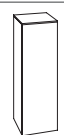
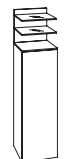
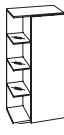
Beschreibung Description	Maße in cm Dimensions in cm			Artikel-Nr. Article no.	Türanschlag Door stop	Identnummer ID number
	B/W	H	T/D			
 <p>Mineralmarmor-Waschtisch Ablage rechts inkl. Permanentablauf</p> <p><i>marble minerals washbasin depot on the right incl. permanent drain valve</i></p>	60,0	1,2/ 12,4	22,0 30,0	MWGBD6		1085
 <p>Einhebel-Waschtischarmatur chrom inkl. Zugstange und Befestigungsmaterial</p> <p><i>single lever tap, chrome incl. eccentric tappet and fastening materials</i></p>				MBCAP		208
						PG1
 <p>Waschtisch-Unterschrank <b>mit Griff</b> 1 Tür, 1 Regal mit 2 Glasablagen</p> <p><i>washbasin base cabinet <b>with handle</b> 1 door, 1 shelf with 2 glass boards</i></p>	60,0	47,8 59,0	29,5	WMDTR6		739
 <p>Waschtisch-Unterschrank <b>push to open</b> 1 Tür, 1 Regal mit 2 Glasablagen</p> <p><i>washbasin base cabinet <b>push to open</b> 1 door, 1 shelf with 2 glass boards</i></p>	60,0	47,8 59,0	29,5	WMDTR6P		739
 <p>Spiegelpaneel, Sensorschalter, satiniert, LED Beleuchtung, 4000 K, 20,5 W, 2870 Lumen, EEK G <b>Helligkeit dimmbar</b></p> <p><i>mirror panel, sensor switch, satined, LED-lighting, 4000 K, 20,5 W, 2870 lumen, EEC G <b>brighthness dimmable</b></i></p>	40,0	80,0	2,0	SPLEK4	 	739
 <p>Highboard inkl. Abdeckplatte <b>mit Griff</b> 1 Tür, 2 Glaseinlegeböden</p> <p><i>Highboard incl. top <b>with handle</b> 1 door, 2 glass boards</i></p>	30,0	90,4	17,6	HBLT3FL HBLT3FR	Links/left Rechts/right	554
 <p>Highboard inkl. Abdeckplatte <b>mit Griff</b> 1 Tür, 2 Glaseinlegeböde Regal mit 2 Glasböden oben</p> <p><i>Highboard incl. top <b>with handle</b> 1 door, 2 glass boards shelf with 2 glass boards above</i></p>	30,0	119,0	17,6	HBRT3FL HBRT3FR	Links/left Rechts/right	785

EEK/EEC=Energieeffizienzklasse/energy efficiency category  
Leuchtmittel sind nicht austauschbar / illuminants are not interchangeable.

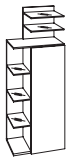
Beschreibung Description	Maße in cm Dimensions in cm			Artikel-Nr. Article no.	Türanschlag Door stop	Identnummer ID number
	B/W	H	T/D			
						PG1
 <p>Highboard inkl. Abdeckplatte <b>mit Griff</b> 1 Tür rechts, 2 Glaseinlegeböden Regal links mit 3 Glasablagen</p> <p><i>Highboard incl. top with handle 1 door right, 2 glass boards shelf left with 3 glass boards</i></p>	45,0	90,4	17,6	<b>HBRT45FL</b> <b>HBRT45FR</b>	Links/ <i>left</i> Rechts/ <i>right</i>	<b>992</b>
 <p>Highboard inkl. Abdeckplatte <b>mit Griff</b> 1 Tür links, 2 Glaseinlegeböden Regal rechts mit 3 Glasablagen</p> <p><i>Highboard incl. top with handle 1 door left, 2 glass boards shelf right with 3 glass boards</i></p>	45,0	90,4	17,6	<b>HBTR45FL</b> <b>HBTR45FR</b>	Links/ <i>left</i> Rechts/ <i>right</i>	<b>992</b>
 <p>Highboard inkl. Abdeckplatte <b>mit Griff</b> 1 Tür rechts, 2 Glaseinlegeböden Regal links mit 3 Glasablagen, Regal mit 2 Glasböden oben</p> <p><i>Highboard incl. top with handle 1 door right, 2 glass boards shelf left with 3 glass boards shelf with 2 glass boards above</i></p>	45,0	119,0	17,6	<b>HBRRT45L</b> <b>HBRRT45R</b>	Links/ <i>left</i> Rechts/ <i>right</i>	<b>1246</b>
 <p>Highboard inkl. Abdeckplatte <b>mit Griff</b> 1 Tür links, 2 Glaseinlegeböden Regal rechts mit 3 Glasablagen, Regal mit 2 Glasböden oben</p> <p><i>Highboard incl. top with handle 1 door left, 2 glass boards shelf right with 3 glass boards, shelf with 2 glass boards above</i></p>	45,0	119,0	17,6	<b>HBTR45L</b> <b>HBTR45R</b>	Links/ <i>left</i> Rechts/ <i>right</i>	<b>1246</b>
 <p>Highboard inkl. Abdeckplatte <b>push to open</b>, 1 Tür, 2 Glaseinlegeböden</p> <p><i>Highboard incl. top push to open, 1 door, 2 glass boards</i></p>	30,0	90,4	17,6	<b>HBLT3PFL</b> <b>HBLT3PFR</b>	Links/ <i>left</i> Rechts/ <i>right</i>	<b>554</b>
 <p>Highboard inkl. Abdeckplatte <b>push to open</b>, 1 Tür, 2 Glaseinlegeböden Regal mit 2 Glasböden oben</p> <p><i>Highboard incl. top push to open, 1 door, 2 glass boards shelf with 2 glass boards above</i></p>	30,0	119,0	17,6	<b>HBRT3PFL</b> <b>HBRT3PFR</b>	Links/ <i>left</i> Rechts/ <i>right</i>	<b>785</b>
 <p>Highboard inkl. Abdeckplatte <b>push to open</b>, 1 Tür rechts, 2 Glaseinlegeböden Regal links mit 3 Glasablagen</p> <p><i>Highboard incl. top push to open 1 door right, 2 glass boards shelf left with 3 glass boards</i></p>	45,0	90,4	17,6	<b>HBRT45PFL</b> <b>HBRT45PFR</b>	Links/ <i>left</i> Rechts/ <i>right</i>	<b>992</b>
 <p>Highboard inkl. Abdeckplatte <b>push to open</b>, 1 Tür links, 2 Glaseinlegeböden Regal rechts mit 3 Glasablagen</p> <p><i>Highboard incl. top push to open 1 door left, 2 glass boards shelf right with 3 glass boards</i></p>	45,0	90,4	17,6	<b>HBTR45PFL</b> <b>HBTR45PFR</b>	Links/ <i>left</i> Rechts/ <i>right</i>	<b>992</b>

Beschreibung Description	Maße in cm Dimensions in cm			Artikel-Nr. Article no.	Türanschlag Door stop	Identnummer ID number
	B/W	H	T/D			
PG 1						
 <p>Highboard inkl. Abdeckplatte <b>push to open</b>, 1 Tür rechts, 2 Glaseinlegeböden Regal links mit 3 Glasablagen, Regal mit 2 Glasböden oben</p> <p><i>Highboard incl. top <b>push to open</b> 1 door right, 2 glass boards shelf left with 3 glass boards, shelf with 2 glass boards above</i></p>	45,0	119,0	17,6	<b>HBRT45PL</b> <b>HBRT45PR</b>	Links/ <i>left</i> Rechts/ <i>right</i>	<b>1246</b>
 <p>Highboard inkl. Abdeckplatte <b>push to open</b>, 1 Tür links, 2 Glaseinlegeböden Regal rechts mit 3 Glasablagen, Regal mit 2 Glasböden oben</p> <p><i>Highboard incl. top <b>push to open</b> 1 door left, 2 glass boards shelf right with 3 glass boards, shelf with 2 glass boards above</i></p>	45,0	119,0	17,6	<b>HBTR45PL</b> <b>HBTR45PR</b>	Links/ <i>left</i> Rechts/ <i>right</i>	<b>1246</b>
 <p><b>i</b> Regal freihängend inkl. Aufhänger</p> <p><i>shelf free-hanging incl. Hanging brackets</i></p>	29,6	28,6	15,0	<b>RGB3</b>		<b>254</b>

**i** Regalfarben unbedingt mit angeben, Übersicht siehe Seite 8. *Please indicate shelf colours, overview see page 8.*





# PLANBAD PLANNED BATH







# 3360line

3360





# »3360line«

## Piktogramme/pictograms



Mineralmarmor Waschtisch  
Marble minerals washbasin



LED Lichtfarbe kalt  
LED colour temperature cold

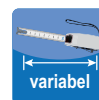

Waschtischplatte maßvariabel  
washbasin plate made to measure



Keramik Waschtisch  
Ceramic washbasin



LED Lichtfarbe warm  
LED colour temperature warm



LED mit Sensorschalter,  
Helligkeit dimmbar  
LED with sensor switch,  
brightness dimmable



Waschtischplatte freihängend?  
Konsolle bestellen  
Washbasin plate free-hanging?  
Order console

## Mineralmarmor Waschbecken weiß alpin Glanz (FE69) Marble minerals on-top washbasin gloss alpine white (FE69)

≈ Beckenmaße in cm (BxHxT)  
basin dimensions in cm (WxHxD)

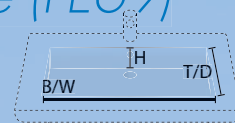

### Inga



MWING6 | 57 x 12 x 31 cm



Detail

## Keramik Waschbecken weiß alpin Glanz (FEK) Ceramic on-top washbasin gloss alpine white (FEK)



### Bella



KWBEL7 | 69 x 11 x 29 cm

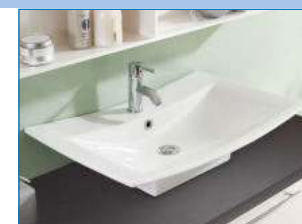

Detail



### Poco



KWPOC55 | 50 x 11 x 30 cm



Detail



### Rumba



KWAWG6 | 59,6 x 9,9 x 32,7 cm



**Weiß Glanz**  
Gloss White  
FEK



**Schwarz Matt**  
Matt Black  
FEKB



Detail

## Waschtischplattenfarben/washbasin plate colours

19 mm Plattenstärke/plate thickness  
PG 1

PG 2



**Eiche Struktur Natur Nachbildung**  
*Oak Structure Nature Finish*  
FE55



**Eiche Struktur Braun Nachbildung** NEW  
*Oak Structure Brown Finish*  
FE70

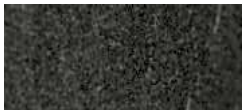

**Query Steindekor**  
*Query Stone Decor*  
FE92



**Nature Steindekor**  
*Nature Stone Decor*  
FE93



**Schwarz Supermatt**  
*Black Super Matt*  
FE88  
**Anti-Fingerprint-Beschichtung**  
*Anti-Fingerprint coating*



## Waschtischplattenfarben/washbasin plate colours

38 mm Plattenstärke/plate thickness



**Eiche Struktur Natur Nachbildung**  
*Oak Structure Nature Finish*  
FE55

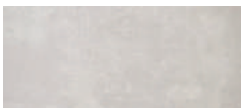

**Polaris**  
*Polaris*  
FE96



**Prado Achatgrau**  
*Prado Achatgrey*  
FE97



# »3360line«

## Schränke/cabinets 3360line

### Frontfarben/front colours

#### Dickkante/thick edge



**286**  
**Weiß Seidenglanz**  
*Silk Gloss White*  
FEE\_



**284**  
**Anthrazit Seidenglanz**  
*Silk Gloss Anthracite*  
FEA\_



**490**  
**Kastanie Graphit Nachbildung**  
*Graphite Chestnut Finish*  
FEC\_



**473**  
**Eiche Struktur Natur Nachbildung**  
*Oak Structure Nature Finish*  
FEM\_



**435**  
**Eiche Struktur Weiß Nachbildung**  
*Oak Structure White Finish*  
FEL\_



**426**  
**Eiche Struktur Braun Nachbildung**  
*Oak Structure Brown Finish*  
FEH\_

#### MDF-folier/MDF-coated



**961**  
**Weiß Glanz**  
*Gloss White*  
FEG\_



**438**  
**Anthrazit Glanz**  
*Gloss Anthracite*  
FEF\_

## Korpusfarben/basic shell colours

#### PG 1 Dickkante/thick edge



**286**  
**Weiß Seidenglanz**  
*Silk Gloss White*  
E/FE86



**284**  
**Anthrazit Seidenglanz**  
*Silk Gloss Anthracite*  
A/FE84



**490**  
**Kastanie Graphit Nachbildung**  
*Graphite Chestnut Finish*  
C/FE45



**473**  
**Eiche Struktur Natur Nachbildung**  
*Oak Structure Nature Finish*  
M/FE55



**435**  
**Eiche Struktur Weiß Nachbildung**  
*Oak Structure White Finish*  
L/FE40



**426**  
**Eiche Struktur Braun Nachbildung**  
*Oak Structure Brown Finish*  
H/FE70

#### PG 3 MDF-folier/MDF-coated



**042**  
**Weiß Glanz Folie**  
*Gloss White*  
G/FE50









**438**  
**Anthrazit Glanz Folie**  
*Gloss Anthracite*  
F/FE30

#### BITTE BEACHTEN:

Die Front-/Korpuskombination „MDF-folierte FRONT (Variante: 438/961)“ mit „Korpus PG1 (Variante: 284/286/426/435/473/490)“ wird zu PG2 abgerechnet.  
The front / basic shell combination „MDF-foiled front (variant: 438/961)“ with „basic shell PG1 (variant: 284/286/426/435/473/490)“ is billed to PG2.

## Regalfarben/ shelf colours

<p><b>287</b></p>  <p><b>Weiß Seidenglanz</b> Silk Gloss White FE86</p>	<p><b>285</b></p>  <p><b>Anthrazit Seidenglanz</b> Silk Gloss Anthracite FE84</p>
<p><b>491</b></p>  <p><b>Kastanie Graphit Nachbildung</b> Graphite Chestnut Finish FE45</p>	<p><b>474</b></p>  <p><b>Eiche Struktur Natur Nachbildung</b> Oak Structure Nature Finish FE55</p>
<p><b>436</b></p>  <p><b>Eiche Struktur Weiß Nachbildung</b> Oak Structure White Finish FE40</p>	<p><b>427</b></p>  <p><b>Eiche Struktur Braun Nachbildung</b> Oak Structure Brown Finish FE70</p>

## Griffe/handles



**Edelstahl Optik**  
Stainless design

Griffnummer/handlenumber: 265/266/386/267/268/269/270

⊕-⊕ 96 mm/128 mm/192 mm/256 mm/179-179 mm\*/179-179 mm\*/279-279 mm\*



**Schwarz Matt Struktur**  
Matt Black Structure

Griffnummer/handlenumber: 272/273/271/274/275/276/277

⊕-⊕ 96 mm/128 mm/192 mm/256 mm/179-179 mm\*/179-179 mm\*/279-279 mm\*

⊕-⊕ = Bohrabstand/hole spacing \*drei Grifflochbohrungen

Die Angabe einer Griffnummer ist ausreichend. Die Griffe werden passend zur jeweiligen Schrankbreite beigelegt.  
The indication of one handle number is sufficient. The handles are supplied to match the respective cabinet width.

## Beleuchtung / lighting



**Aufbauleuchte LED**  
Top light LED



**Seitlich und oben LED Beleuchtung**  
lateral and top LED lighting

**Lichtfarbe Tageslicht (Kalt)**

Louminous colour natural light (cold)













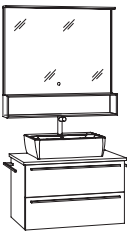



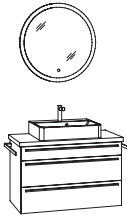

AW80, AWP80,  
AWP90,  
AW100, AWP100  
AW120, AWP120

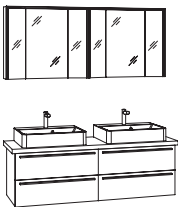

Die Steckdose / Powerbox für Spiegelschränke ist auch in Ausführung für die Schweiz / Frankreich erhältlich. Bitte Mehrpreis beachten (siehe Seite 21).  
The power socket for mirror cabinets is also available for Switzerland / France. Please note extra charge (see page 21).

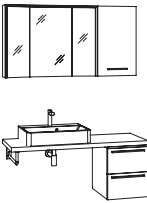

# 3360line »Beispiel-Kombinationen/example-combinations«

Beschreibung Description	Maße in cm Dimensions in cm			Artikel-Nr. Article no.	Türanschlag Door stop	Identnummer ID number		
	B/W	H	T/D			PG1	PG2	PG3
 <p>Kombination 80 cm bestehend aus: LED-Aufbauleuchte 80 cm Spiegelpaneel, Sensorschalter 80 cm Regal unter dem Spiegelpaneel 80 cm Aufsatz-Keramik-Waschbecken Poco weiß Waschtischplatte 19 mm <b>aus PG1</b> (Breite 80 cm) Waschtisch-Unterschrank 77 cm Handtuchhalter Handtuchhalter</p> <p><i>combination 80 cm width consisting of: LED top lighting 80 cm mirror panel, sensor switch 80 cm shelf below mirror panel 80 cm on-top ceramic washbasin Poco white washbasin plate 19 mm <b>from PG1</b> (width 80 cm) washbasin base cabinet 77 cm towel rail (2x)</i></p>	AWP80 SPBSA8 SRB8 KWPOC55 WTFP8M WPWSA7 HHF133 HHF133	  	370	370	370			
			1154	1154	1154			
			346	346	346			
			646	646	646			
			461	461	461			
			1407	1799	2215			
			102	102	102			
			102	102	102			
			<b>4588</b>	<b>4980</b>	<b>5396</b>			
			<b>Waschtischplattenfarbe aus PG1 washbasin plate colour from PG1</b>					
 <p>Kombination 100 cm bestehend aus: Spiegelpaneel, Sensorschalter 78 cm Aufsatz-Mineralmarmor-Waschbecken Inga Waschtischplatte 38 mm (Breite 100 cm) Waschtisch-Unterschrank 97 cm Handtuchhalter Handtuchhalter</p> <p><i>combination 100 cm width consisting of: mirror panel, sensor switch 78 cm on-top marble minerals washbasin Inga washbasin plate 38 mm (width 100 cm) washbasin base cabinet 97 cm towel rail (2x)</i></p>	SPK78 MWING6 WTFI10M WPWSA9 RHH RHH	  	1292	1292	1292			
			1038	1038	1038			
			577	577	577			
			1846	2261	2676			
			195	195	195			
			195	195	195			
			<b>5143</b>	<b>5558</b>	<b>5973</b>			
 <p>Kombination ca. 160 cm bestehend aus: Spiegelschrank, 3 Spiegeltüren 80 cm Spiegelschrank, 3 Spiegeltüren 80 cm Aufsatz-Mineralmarmor-Waschbecken Inga Aufsatz-Mineralmarmor-Waschbecken Inga Variable Waschtischplatte 38 mm (Breite 154,4 cm) Waschtisch-Unterschrank 77 cm Waschtisch-Unterschrank 77 cm</p> <p><i>combination ca. 160 cm width consisting of: mirror cabinet, 3 mirror doors 80 cm mirror cabinet, 3 mirror doors 80 cm on-top marble minerals washbasin Inga on-top marble minerals washbasin Inga variable washbasin plate 38 mm (width 154,4 cm) washbasin base cabinet 77 cm washbasin base cabinet 77 cm</i></p>	SDU8 SDU8 MWING6 MWING6 WTFV10 WPWSA7 WPWSA7	   	2238	2238	2238			
			2238	2238	2238			
			1038	1038	1038			
			1038	1038	1038			
			1152	1152	1152			
			1407	1799	2215			
			1407	1799	2215			
			<b>10518</b>	<b>11302</b>	<b>12134</b>			
 <p>Kombination 130 cm bestehend aus: Spiegelschrank, 3 Spiegeltüren 90 cm Oberschrank, 1 Tür 40 cm Aufsatz-Keramik-Waschbecken Rumba weiß Variable Waschtischplatte 19 mm <b>aus PG1</b> (Breite 130 cm) Unterschrank, 2 Auszüge 40 cm Designsiphon Waschtischkonsole mit Handtuchhalter</p> <p><i>ombination 130 cm width consisting mirror cabinet, 3 mirror doors 90 cm top cabinet, 1 door 40 cm on-top ceramic washbasin Rumba white variable washbasin plate 19 mm <b>from PG1</b> (width 130cm) base cabinet, 2 extensions 40 cm design siphon washbasin console with towel rail</i></p>	SDU9 OT40DR KWAWG6 WTFV10 UWAA4 DS HK45	  	2307	2307	2307			
			461	554	623			
			1107	1107	1107			
			936	936	936			
			946	1246	1638			
			236	236	236			
			397	397	397			
			<b>6390</b>	<b>6783</b>	<b>7244</b>			
			<b>Waschtischplattenfarbe aus PG1 washbasin plate colour from PG1</b>					

Handtuchhalter, Regale, Unterbauleuchtungen und weiteres Zubehör finden Sie in der Rubrik 3970zubehör.  
Towel rails, shelves, base lightings and other accessories can be found in the 3970accessories range.

# 3360line »Waschtische/washbasins«

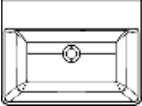
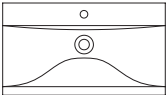
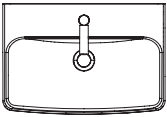
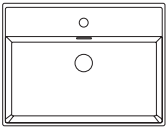
Beschreibung Description	Maße in cm Dimensions in cm			Artikel-Nr. Article no.	Waschtisch Washbasin	Identnummer ID number	
	B/W	H	T/D				
 <p>Aufsatz-Mineralmarmor-Waschtisch inkl. Überlaufgarnitur und Montageset MONK-4</p> <p><i>on-top marble minerals washbasin incl. overflow and mounting-set MONK-4</i></p>	60,0	12,0	45,0	<b>MWING6</b>	<b>INGA</b>	<b>1038</b>	
 <p>Aufsatz-Keramik-Waschtisch inkl. Überlauf und Montageset MONK-4</p> <p><i>on-top ceramic washbasin incl. overflow and mounting-set MONK-4</i></p>	71,0	16,0	44,5	<b>KWBEL7</b>	<b>BELLA</b>	<b>900</b>	
 <p>Aufsatz-Keramik-Waschtisch inkl. Überlauf und Montageset MONK-4</p> <p><i>on-top ceramic washbasin incl. overflow and mounting-set MONK-4</i></p>	56,0	15,0	38,0	<b>KWPOC55</b>	<b>POCO</b>	<b>646</b>	
 <p>Aufsatz-Keramik-Waschtisch inkl. Überlauf und Montageset MONK-4</p> <p><i>on-top ceramic washbasin incl. overflow and mounting-set MONK-4</i></p>	61,2	12,0	46,6	<b>KWAWG6</b>	<b>RUMBA</b>	<b>FEK</b> Weiß Glanz/ <i>gloss white</i>	<b>FEKB</b> Schwarz Matt/ <i>matt black</i>

BITTE BEACHTEN: Sehen Sie die unterschiedlichen Maße der Waschtischplattenfräsungen auf Seite 22 - 23  
PLEASE NOTE: see the different dimensions of the washbasin plate notchs on page 22 - 23

# 3360line »Waschtischplatten 19mm/washbasin plates 19mm«



Beschreibung Description	Maße in cm Dimensions in cm			Artikel-Nr. Article no.	Waschtisch Washbasin	Identnummer ID number	
	B/W	H	T/D				

Die Waschtischkonsole WK finden Sie auf Seite 21  
The washbasin console WK can be found on page 21

						PG 1	PG 2
<p>Waschtischplatte inkl. Ausfräsung mittig Fixmaß, Plattenstärke 19mm</p> <p>Washbasin plate <b>with central notch</b> fixed size, plate thickness 19mm</p>	80,4	1,9	48,5	WTF18M	INGA	461	692
				WTFB8M	BELLA		
				WTFP8M	POCO		
				WTFA8M	RUMBA		
<p>Waschtischplatte inkl. Ausfräsung mittig Fixmaß, Plattenstärke 19mm</p> <p>Washbasin plate <b>with central notch</b> fixed size, plate thickness 19mm</p>	100,4	1,9	48,5	WTF110M	INGA	554	830
				WTFB110M	BELLA		
				WTFP110M	POCO		
				WTFA110M	RUMBA		
<p>Waschtischplatte inkl. Ausfräsung links Fixmaß, Plattenstärke 19mm</p> <p>Washbasin plate <b>with notch left</b> fixed size, plate thickness 19mm</p>	120,4	1,9	48,5	WTF112L	INGA	646	969
				WTFB112L	BELLA		
				WTFP112L	POCO		
				WTFA112L	RUMBA		
<p>Waschtischplatte inkl. Ausfräsung rechts Fixmaß, Plattenstärke 19mm</p> <p>Washbasin plate <b>with notch right</b> fixed size, plate thickness 19mm</p>	120,4	1,9	48,5	WTF112R	INGA	646	969
				WTFB112R	BELLA		
				WTFP112R	POCO		
				WTFA112R	RUMBA		
<p>Waschtischplatte inkl. Ausfräsung mittig Fixmaß, Plattenstärke 19mm</p> <p>Washbasin plate <b>with central notch</b> fixed size, plate thickness 19mm</p>	120,4	1,9	48,5	WTF112M	INGA	646	969
				WTFB112M	BELLA		
				WTFP112M	POCO		
				WTFA112M	RUMBA		
<p>Waschtischplatte ohne Ausfräsung Fixmaß, Plattenstärke 19mm</p> <p>Washbasin plate <b>without notch</b> fixed size, plate thickness 19mm</p>	80,4	1,9	48,5	WTF8		439	670
	100,4	1,9	48,5	WTF10		530	808
	120,4	1,9	48,5	WTF12		623	946
<p>Waschtischplatte ohne Ausfräsung Variables Maß, Plattenstärke 19mm Die Platte kann in cm-Schritten im Wunschmaß von 80,4 bis 200,4 cm bestellt werden.</p> <p>Washbasin plate <b>without notch</b> variable size, plate thickness 19mm The plate can be ordered in a width of 80,4 to 200,4 cm in steps of 1 cm.</p>	10,0	1,9	48,5	WTFV10		72	106
							Preis pro angefangene 10 cm Price per 10 cm or part thereof
<p>Bei Planung mit Unterschränken empfehlen wir einen seitlichen Überstand von mindestens 0,2 cm auf jeder Seite zu berücksichtigen. When planning with base units we recommend considering an overhang of at least 0.2 cm on each side.</p>							

**i** Waschtischplattenfarben unbedingt mit angeben, Übersicht siehe Seite 2 / Please indicate washbasin plate colours, overview see page 2  
Die Ausfräsungen sind beispielhaft, weitere Informationen auf den Seiten 22 - 23 / The notches are exemplary, further information on pages 22 - 23



Beschreibung Description	Maße in cm Dimensions in cm			Artikel-Nr. Article no.	Waschtisch Washbasin	Identnummer ID number
	B/W	H	T/D			

Die Waschtischkonsole WK finden Sie auf Seite 21  
The washbasin console WK can be found on page 21

	Waschtischplatte inkl. Ausfräsung mittig Fixmaß, Plattenstärke 38mm	80,4	3,8	48,5	WTPI8M	INGA	485
	Washbasin plate with central notch fixed size, plate thickness 38mm				WTPB8M	BELLA	
					WTPP8M	POCO	
					WTPA8M	RUMBA	
	Waschtischplatte inkl. Ausfräsung mittig Fixmaß, Plattenstärke 38mm	100,4	3,8	48,5	WTPI10M	INGA	577
	Washbasin plate with central notch fixed size, plate thickness 38mm				WTPB10M	BELLA	
					WTPP10M	POCO	
					WTPA10M	RUMBA	
	Waschtischplatte inkl. Ausfräsung links Fixmaß, Plattenstärke 38mm	120,4	3,8	48,5	WTPI12L	INGA	670
	Washbasin plate with notch left fixed size, plate thickness 38mm				WTPB12L	BELLA	
					WTPP12L	POCO	
					WTPA12L	RUMBA	
	Waschtischplatte inkl. Ausfräsung rechts Fixmaß, Plattenstärke 38mm	120,4	3,8	48,5	WTPI12R	INGA	670
	Washbasin plate with notch right fixed size, plate thickness 38mm				WTPB12R	BELLA	
					WTPP12R	POCO	
					WTPA12R	RUMBA	
	Waschtischplatte inkl. Ausfräsung mittig Fixmaß, Plattenstärke 38mm	120,4	3,8	48,5	WTPI12M	INGA	670
	Washbasin plate with central notch fixed size, plate thickness 38mm				WTPB12M	BELLA	
					WTPP12M	POCO	
					WTPA12M	RUMBA	
	Waschtischplatte ohne Ausfräsung Fixmaß, Plattenstärke 38mm	80,4	3,8	48,5	WTP8		461
	Washbasin plate without notch fixed size, plate thickness 38mm	100,4	3,8	48,5	WTP10		554
		120,4	3,8	48,5	WTP12		646
	Waschtischplatte ohne Ausfräsung Variables Maß, Plattenstärke 38mm Die Platte kann in cm-Schritten im Wunschmaß von 80,4 bis 200,4 cm bestellt werden.	10,0	3,8	48,5	WTPV10		72
	Washbasin plate without notch variable size, plate thickness 38mm The plate can be ordered in a width of 80,4 to 200,4 cm in steps of 1 cm.						Preis pro angefangene 10 cm Price per 10 cm or part thereof
<p>Bei Planung mit Unterschränken empfehlen wir einen seitlichen Überstand von mindestens 0,2 cm auf jeder Seite zu berücksichtigen. When planning with base units we recommend considering an overhang of at least 0.2 cm on each side.</p>							

**i** Waschtischplattenfarben unbedingt mit angeben, Übersicht siehe Seite 2 / Please indicate washbasin plate colours, overview see page 2  
Die Ausfräsungen sind beispielhaft, weitere Informationen auf den Seiten 22 - 23 / The notches are exemplary, further information on pages 22 - 23

# 3360line »Unter- und Oberschrank-Regale variabel / base & wall unit shelves variable«

Beschreibung Description	Maße in cm Dimensions in cm			Artikel-Nr. Article no.	Türanschlag Door stop	Identnummer ID number
	B/W	H	T/D			

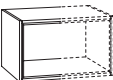
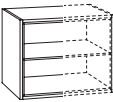









	Unterschrankregal variabel 1 offenes Einschubfach, inkl. Aufhängung <i>base cabinet shelf variable 1 open case, incl. hanging brackets</i>	15,0 - 60,0	23,8	46,0	RFAV6	575
	Unterschrankregal variabel 1 offenes Einschubfach, inkl. Aufhängung <i>base cabinet shelf variable 1 open case, incl. hanging brackets</i>	15,0 - 60,0	36,6	46,0	RFBV6	671
	Unterschrankregal variabel 1 offenes Einschubfach, 1 fester Einlege- boden, inkl. Aufhängung <i>base cabinet shelf variable 1 open case, 1 fixed shelf incl. hanging brackets</i>	15,0 - 60,0	47,8	46,0	RFCV6	767









**BITTE BEACHTEN:** Das Unterschrankregal und das offene Einschubfach können in voneinander abweichenden Dekoren bestellt werden.  
**PLEASE NOTE:** The base cabinet shelf and the open case can be ordered in different colours.

	Oberschrankregal für Spiegelschrank/- paneel 3 feste Einlegeböden, inkl. Aufhängung <b>Bei Bestellung Breite des Regals angeben!</b>  <i>wall unit shelf for mirror cabinet/- panel 3 fixed shelves, incl. mounting hange When ordering, please state the width of the shelf!</i>	15,0 - 60,0	68,2	15,6	REBV	769
--	--	----------------	------	------	------	-----

Die Regale können in cm-Schritten von 15-60 cm Breite individuell bestellt werden / *the shelves can be ordered in cm steps from 15-60 cm wide*

 Regalfarben unbedingt mit angeben, Übersicht siehe Seite 4. *Please indicate shelf colours, overview see page 4.*











Beschreibung <i>Description</i>	Maße in cm <i>Dimensions in cm</i>			Artikel-Nr. <i>Article no.</i>	Türanschlag <i>Door stop</i>	Identnummer <i>ID number</i>		
	B/W	H	T/D			PG1	PG2	PG3
 Waschtisch-Unterschrank mit Siphon-Ausschnitt mittig, 1 Schubkasten <i>washbasin base cabinet with siphon-cutout center, 1 drawer</i>	77,0	23,8	48,0	WPWS7		946	1107	1384
 Waschtisch-Unterschrank mit Siphon-Ausschnitt mittig, 2 Schubkästen <i>washbasin base cabinet with siphon-cutout center, 2 drawers</i>	77,0	36,6	48,0	WPWSS7		1269	1431	1707
 Waschtisch-Unterschrank mit Siphon-Ausschnitt mittig, 1 Schubkasten, 1 Auszug <i>washbasin base cabinet with siphon-cutout center, 1 drawer, 1 extension</i>	77,0	47,8	48,0	WPWSA7		1407	1799	2215
 Waschtisch-Unterschrank mit Siphon-Ausschnitt mittig, 2 Schubkästen, 1 Auszug <i>washbasin base cabinet with siphon-cutout center, 2 drawers, 1 extension</i>	77,0	60,6	48,0	WPWSSA7		1684	2123	2538
 Waschtisch-Unterschrank mit Siphon-Ausschnitt mittig, 1 Schubkasten <i>washbasin base cabinet with siphon-cutout center, 1 drawer</i>	97,0	23,8	48,0	WPWS9		1016	1176	1453
 Waschtisch-Unterschrank mit Siphon-Ausschnitt mittig, 2 Schubkästen <i>washbasin base cabinet with siphon-cutout center, 2 drawers</i>	97,0	36,6	48,0	WPWSS9		1362	1546	1846
 Waschtisch-Unterschrank mit Siphon-Ausschnitt mittig, 1 Schubkasten, 1 Auszug <i>washbasin base cabinet with siphon-cutout center, 1 drawer, 1 extension</i>	97,0	47,8	48,0	WPWSA9		1546	1846	2261
 Waschtisch-Unterschrank mit Siphon-Ausschnitt mittig, 2 Schubkästen, 1 Auszug <i>washbasin base cabinet with siphon-cutout center, 2 drawers, 1 extension</i>	97,0	60,6	48,0	WPWSSA9		1846	2261	2676
 Waschtisch-Unterschrank mit Siphon-Ausschnitt links, 1 Schubkasten <i>washbasin base cabinet with siphon-cutout left, 1 drawer</i>	117,0	23,8	48,0	WPWS11L		1061	1292	1591
 Waschtisch-Unterschrank mit Siphon-Ausschnitt rechts, 1 Schubkasten <i>washbasin base cabinet with siphon-cutout right, 1 drawer</i>	117,0	23,8	48,0	WPWS11R		1061	1292	1591
 Waschtisch-Unterschrank mit Siphon-Ausschnitt mittig, 1 Schubkasten <i>washbasin base cabinet with siphon-cutout center, 1 drawer</i>	117,0	23,8	48,0	WPWS11M		1061	1292	1591

Beschreibung Description	Maße in cm Dimensions in cm			Artikel-Nr. Article no.	Türanschlag Door stop	Identnummer ID number		
	B/W	H	T/D			PG1	PG2	PG3
 <p>Waschtisch-Unterschrank mit Siphon-Ausschnitt links, 2 Schubkästen <i>washbasin base cabinet with siphon-cutout left, 2 drawers</i></p>	117,0	36,6	48,0	WPWSS11L		1453	1684	2053
 <p>Waschtisch-Unterschrank mit Siphon-Ausschnitt rechts, 2 Schubkästen <i>washbasin base cabinet with siphon-cutout right, 2 drawers</i></p>	117,0	36,6	48,0	WPWSS11R		1453	1684	2053
 <p>Waschtisch-Unterschrank mit Siphon-Ausschnitt mittig, 2 Schubkästen <i>washbasin base cabinet with siphon-cutout center, 2 drawers</i></p>	117,0	36,6	48,0	WPWSS11M		1453	1684	2053
 <p>Waschtisch-Unterschrank mit Siphon-Ausschnitt links, 1 Schubkasten, 1 Auszug <i>washbasin base cabinet with siphon-cutout left, 1 drawer, 1 extension</i></p>	117,0	47,8	48,0	WPWSA11L		1661	2053	2423
 <p>Waschtisch-Unterschrank mit Siphon-Ausschnitt rechts, 1 Schubkasten, 1 Auszug <i>washbasin base cabinet with siphon-cutout right, 1 drawer, 1 extension</i></p>	117,0	47,8	48,0	WPWSA11R		1661	2053	2423
 <p>Waschtisch-Unterschrank mit Siphon-Ausschnitt mittig, 1 Schubkasten, 1 Auszug <i>washbasin base cabinet with siphon-cutout center, 1 drawer, 1 extension</i></p>	117,0	47,8	48,0	WPWSA11M		1661	2053	2423
 <p>Waschtisch-Unterschrank mit Siphon-Ausschnitt links, 2 Schubkästen, 1 Auszug <i>washbasin base cabinet with siphon-cutout left, 2 drawers, 1 extension</i></p>	117,0	60,6	48,0	WPWSSA11L		1984	2353	2745
 <p>Waschtisch-Unterschrank mit Siphon-Ausschnitt rechts, 2 Schubkästen, 1 Auszug <i>washbasin base cabinet with siphon-cutout right, 2 drawers, 1 extension</i></p>	117,0	60,6	48,0	WPWSSA11R		1984	2353	2745
 <p>Waschtisch-Unterschrank mit Siphon-Ausschnitt mittig, 2 Schubkästen, 1 Auszug <i>washbasin base cabinet with siphon-cutout center, 2 drawers, 1 extension</i></p>	117,0	60,6	48,0	WPWSSA11M		1984	2353	2745

# 3360line »Erweiterung der Waschtischlösungen/Extension of the washbasin solutions«

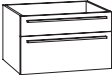
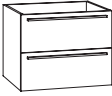
Beschreibung Description	Maße in cm Dimensions in cm			Artikel-Nr. Article no.	Türanschlag Door stop	Identnummer ID number		
	B/W	H	T/D					

## Ohne Abdeckplatte / without top

						PG1	PG2	PG3
	Unterschrank 1 Auszug  <i>base cabinet 1 extension</i>	40,0	23,8	48,0	<b>UWAA4</b>	<b>646</b>	<b>761</b>	<b>1085</b>
	Unterschrank 1 Schubkasten, 1 Auszug  <i>base cabinet 1 drawer, 1 extension</i>	40,0	36,6	48,0	<b>UWSA4</b>	<b>900</b>	<b>1107</b>	<b>1476</b>
	Unterschrank 2 Auszüge  <i>base cabinet 2 extensions</i>	40,0	47,8	48,0	<b>UWAA4</b>	<b>946</b>	<b>1246</b>	<b>1638</b>
	Unterschrank 1 Schubkasten, 2 Auszüge  <i>base cabinet 1 drawer, 2 extensions</i>	40,0	60,6	48,0	<b>UWSAA4</b>	<b>1269</b>	<b>1500</b>	<b>2076</b>
	 Unterschrank 1 Schubkasten, 1 Einschubregal, 1 Auszug  <i>base cabinet 1 drawer, 1 push-in shelf, 1 extension</i>	40,0	60,6	48,0	<b>UWSEA4</b>	<b>1154</b>	<b>1384</b>	<b>1799</b>
	Unterschrank 1 Auszug  <i>base cabinet 1 extension</i>	60,0	23,8	48,0	<b>UWA6</b>	<b>670</b>	<b>808</b>	<b>1200</b>
	Unterschrank 1 Schubkasten, 1 Auszug  <i>base cabinet 1 drawer, 1 extension</i>	60,0	36,6	48,0	<b>UWSA6</b>	<b>1038</b>	<b>1223</b>	<b>1638</b>
	Unterschrank 2 Auszüge  <i>base cabinet 2 extensions</i>	60,0	47,8	48,0	<b>UWAA6</b>	<b>1085</b>	<b>1269</b>	<b>1730</b>
	Unterschrank 1 Schubkasten, 2 Auszüge  <i>base cabinet 1 drawer, 2 extensions</i>	60,0	60,6	48,0	<b>UWSAA6</b>	<b>1362</b>	<b>1661</b>	<b>2123</b>
	 Unterschrank 1 Schubkasten, 1 Einschubregal, 1 Auszug  <i>base cabinet 1 drawer, 1 push-in shelf, 1 extension</i>	60,0	60,6	48,0	<b>UWSEA6</b>	<b>1292</b>	<b>1522</b>	<b>2076</b>









 Regalfarben unbedingt mit angeben, Übersicht siehe Seite 4. Please indicate shelf colours, overview see page 4



# 3360line »Erweiterung der Waschtischlösungen/Extension of the washbasin solutions«

Beschreibung Description	Maße in cm Dimensions in cm			Artikel-Nr. Article no.	Türanschlag Door stop	Identnummer ID number		
	B/W	H	T/D					









## Ohne Abdeckplatte / without top

						PG1	PG2	PG3
	Unterschrank 1 Auszug  <i>base cabinet 1 extension</i>	97,0	23,8	48,0	<b>UWA9</b>	<b>830</b>	<b>1016</b>	<b>1384</b>
	Unterschrank 1 Schubkasten, 1 Auszug  <i>base cabinet 1 drawer, 1 extension</i>	97,0	36,6	48,0	<b>UWSA9</b>	<b>1269</b>	<b>1638</b>	<b>2030</b>
	Unterschrank 2 Auszüge  <i>base cabinet 2 extensions</i>	97,0	47,8	48,0	<b>UWAA9</b>	<b>1315</b>	<b>1684</b>	<b>2076</b>
	Unterschrank 1 Schubkasten, 2 Auszüge  <i>base cabinet 1 drawer, 2 extensions</i>	97,0	60,6	48,0	<b>UWSAA9</b>	<b>1684</b>	<b>2215</b>	<b>2769</b>
	Unterschrank 1 Auszug  <i>base cabinet 1 extension</i>	117,0	23,8	48,0	<b>UWA11</b>	<b>900</b>	<b>1176</b>	<b>1569</b>
	Unterschrank 1 Schubkasten, 1 Auszug  <i>base cabinet 1 drawer, 1 extension</i>	117,0	36,6	48,0	<b>UWSA11</b>	<b>1431</b>	<b>1799</b>	<b>2215</b>
	Unterschrank 2 Auszüge  <i>base cabinet 2 extensions</i>	117,0	47,8	48,0	<b>UWAA11</b>	<b>1476</b>	<b>1868</b>	<b>2353</b>
	Unterschrank 1 Schubkasten, 2 Auszüge  <i>base cabinet 1 drawer, 2 extensions</i>	117,0	60,6	48,0	<b>UWSAA11</b>	<b>1915</b>	<b>2514</b>	<b>3091</b>

# 3360line »Erweiterung der Waschtischlösungen/Extension of the washbasin solutions«

Beschreibung Description	Maße in cm Dimensions in cm			Artikel-Nr. Article no.	Türanschlag Door stop	Identnummer ID number		
	B/W	H	T/D			PG1	PG2	PG3

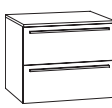
## Mit Abdeckplatte in Korpusfarbe / with top in carcass colour









						PG1	PG2	PG3
	Unterschrank 1 Auszug  <i>base cabinet 1 extension</i>	40,0	25,6	48,5	<b>UWA4F</b>	<b>715</b>	<b>830</b>	<b>1107</b>
	Unterschrank 1 Schubkasten, 1 Auszug  <i>base cabinet 1 drawer, 1 extension</i>	40,0	38,4	48,5	<b>UWSA4F</b>	<b>969</b>	<b>1176</b>	<b>1546</b>
	Unterschrank 2 Auszüge  <i>base cabinet 2 extensions</i>	40,0	49,6	48,5	<b>UWAA4F</b>	<b>1016</b>	<b>1315</b>	<b>1707</b>
	Unterschrank 1 Schubkasten, 2 Auszüge  <i>base cabinet 1 drawer, 2 extensions</i>	40,0	62,4	48,5	<b>UWSAA4F</b>	<b>1338</b>	<b>1569</b>	<b>2145</b>
	<b>i</b> Unterschrank 1 Schubkasten, 1 Einschubregal, 1 Auszug  <i>base cabinet 1 drawer, 1 push-in shelf, 1 extension</i>	40,0	62,4	48,5	<b>UWSEA4F</b>	<b>1223</b>	<b>1453</b>	<b>1868</b>
	Unterschrank 1 Auszug  <i>base cabinet 1 extension</i>	60,0	25,6	48,5	<b>UWA6F</b>	<b>761</b>	<b>900</b>	<b>1200</b>
	Unterschrank 1 Schubkasten, 1 Auszug  <i>base cabinet 1 drawer, 1 extension</i>	60,0	38,4	48,5	<b>UWSA6F</b>	<b>1131</b>	<b>1315</b>	<b>1707</b>
	Unterschrank 2 Auszüge  <i>base cabinet 2 extensions</i>	60,0	49,6	48,5	<b>UWAA6F</b>	<b>1176</b>	<b>1362</b>	<b>1822</b>
	Unterschrank 1 Schubkasten, 2 Auszüge  <i>base cabinet 1 drawer, 2 extensions</i>	60,0	62,4	48,5	<b>UWSAA6F</b>	<b>1453</b>	<b>1753</b>	<b>2215</b>
	<b>i</b> Unterschrank 1 Schubkasten, 1 Einschubregal, 1 Auszug  <i>base cabinet 1 drawer, 1 push-in shelf, 1 extension</i>	60,0	62,4	48,5	<b>UWSEA6F</b>	<b>1384</b>	<b>1615</b>	<b>2168</b>

**i** Regalfarben unbedingt mit angeben, Übersicht siehe Seite 4. Please indicate shelf colours, overview see page 4







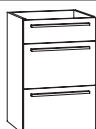

# 3360line »Erweiterung der Waschtischlösungen/Extension of the washbasin solutions«

Beschreibung Description	Maße in cm Dimensions in cm			Artikel-Nr. Article no.	Türanschlag Door stop	Identnummer ID number		
	B/W	H	T/D					

## Mit Abdeckplatte in Korpusfarbe / with top in carcase colour

						PG1	PG2	PG3
	Unterschrank 1 Auszug  <i>base cabinet 1 extension</i>	97,0	25,6	48,5	<b>UWA9F</b>	<b>992</b>	<b>1176</b>	<b>1569</b>
	Unterschrank 1 Schubkasten, 1 Auszug  <i>base cabinet 1 drawer, 1 extension</i>	97,0	38,4	48,5	<b>UWSA9F</b>	<b>1431</b>	<b>1799</b>	<b>2215</b>
	Unterschrank 2 Auszüge  <i>base cabinet 2 extensions</i>	97,0	49,6	48,5	<b>UWAA9F</b>	<b>1476</b>	<b>1846</b>	<b>2284</b>
	Unterschrank 1 Schubkasten, 2 Auszüge  <i>base cabinet 1 drawer, 2 extensions</i>	97,0	62,4	48,5	<b>UWSAA9F</b>	<b>1846</b>	<b>2307</b>	<b>2769</b>
	Unterschrank 1 Auszug  <i>base cabinet 1 extension</i>	117,0	25,6	48,5	<b>UWA11F</b>	<b>1038</b>	<b>1315</b>	<b>1753</b>
	Unterschrank 1 Schubkasten, 1 Auszug  <i>base cabinet 1 drawer, 1 extension</i>	117,0	38,4	48,5	<b>UWSA11F</b>	<b>1569</b>	<b>1961</b>	<b>2423</b>
	Unterschrank 2 Auszüge  <i>base cabinet 2 extensions</i>	117,0	49,6	48,5	<b>UWAA11F</b>	<b>1615</b>	<b>1984</b>	<b>2538</b>
	Unterschrank 1 Schubkasten, 2 Auszüge  <i>base cabinet 1 drawer, 2 extensions</i>	117,0	62,4	48,5	<b>UWSAA11F</b>	<b>2053</b>	<b>2653</b>	<b>3299</b>











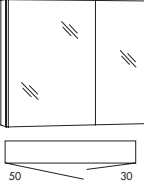



Beschreibung Description	Maße in cm Dimensions in cm			Artikel-Nr. Article no.	Türanschlag Door stop	Identnummer ID number		
	B/W	H	T/D					

Ohne Abdeckplatte / without top						PG1	PG2	PG3	
	Unterschrank ohne Abdeckplatte 1 Schubkasten, 2 Auszüge  <i>base cabinet without top 1 drawer, 2 extensions</i>	40,0	60,6	35,0	<b>UHSAA4</b>	<b>1131</b>	<b>1384</b>	<b>1892</b>	
		Unterschrank ohne Abdeckplatte 1 Schubkasten, 1 Einschubregal, 1 Auszug  <i>base cabinet without top 1 drawer, 1 push-in shelf, 1 extension</i>	40,0	60,6	35,0	<b>UHSEA4</b>	<b>1085</b>	<b>1338</b>	<b>1868</b>
		Unterschrank ohne Abdeckplatte 1 Schubkasten, 2 Auszüge  <i>base cabinet without top 1 drawer, 2 extensions</i>	60,0	60,6	35,0	<b>UHSAA6</b>	<b>1269</b>	<b>1546</b>	<b>1961</b>
		Unterschrank ohne Abdeckplatte 1 Schubkasten, 1 Einschubregal, 1 Auszug  <i>base cabinet without top 1 drawer, 1 push-in shelf, 1 extension</i>	60,0	60,6	35,0	<b>UHSEA6</b>	<b>1223</b>	<b>1500</b>	<b>1915</b>
		Unterschrank ohne Abdeckplatte 1 Schubkasten, 2 Auszüge  <i>base cabinet without top 1 drawer, 2 extensions</i>	97,0	60,6	35,0	<b>UHSAA9</b>	<b>1569</b>	<b>2007</b>	<b>2538</b>
		Unterschrank ohne Abdeckplatte 1 Schubkasten, 2 Auszüge  <i>base cabinet without top 1 drawer, 2 extensions</i>	117,0	60,6	35,0	<b>UHSAA11</b>	<b>1707</b>	<b>2238</b>	<b>2838</b>

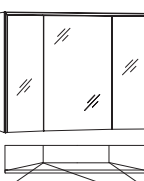
						PG1	Dickkante/thick edge	
	Maßvariable Abdeckplatte für Unterschränke ohne Abdeckplatte  <i>cover panel in variable dimensions for base cabinets without top</i>	200,0 max.	1,6	49,3 max.	<b>ADVF</b>		<b>221</b>	
Artikel nicht lieferbar in Weiß Glanz und Anthrazit Glanz / article not available in White Gloss and Anthracite Gloss								









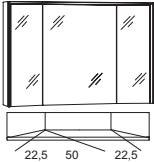

 Regalfarben unbedingt mit angeben, Übersicht siehe Seite 4. Please indicate shelf colours, overview see page 4.

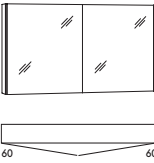
# 3360line »Spiegelschränke/mirror cabinets«

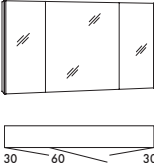
Beschreibung Description	Maße in cm Dimensions in cm			Artikel-Nr. Article no.	Türanschlag Door stop	Identnummer ID number
	B/W	H	T/D			
 <p>Spiegelschrank, 2 beidseitig verspiegelte Türen, 2 Glaseinlegeböden, inkl. Schalter/Steckdose, seitliche LED-Beleuchtung, 6000 K, 2x 6,3 W, 2x 660 Lumen, EEK F</p> <p><i>mirror cabinet, 2 doors mirrored on both sides, 2 glass boards, incl. switch/socket lateral LED-lighting, 6000 K, 2x 6,3 W, 2x 660 lumen, EEC F</i></p>	80,0	68,2	17,6	<b>SADA8L</b>	 <p>Dieses Produkt enthält eine Lichtquelle der Energieeffizienzklasse F</p>	<b>1707</b>
 <p>Spiegelschrank, 2 beidseitig verspiegelte Türen, 2 Glaseinlegeböden, inkl. Schalter/Steckdose, seitliche LED-Beleuchtung, 6000 K, 2x 6,3 W, 2x 660 Lumen, EEK F</p> <p><i>mirror cabinet, 2 doors mirrored on both sides, 2 glass boards, incl. switch/socket lateral LED-lighting, 6000 K, 2x 6,3 W, 2x 660 lumen, EEC F</i></p>	80,0	68,2	17,6	<b>SADA8R</b>	 <p>Dieses Produkt enthält eine Lichtquelle der Energieeffizienzklasse F</p>	<b>1707</b>
 <p>LED-Aufbauleuchte für Spiegelschrank mit LED-Mini-Stecker, 6000 K, 10,8 W, 1350 Lumen, EEK E</p> <p><i>LED-lighting for mirror cabinet with LED-mini-plug, 6000 K, 10,8 W, 1350 lumen, EEC E</i></p>	80,0	2,4	20,0	<b>AW80</b>	 <p>Dieses Produkt enthält eine Lichtquelle der Energieeffizienzklasse E</p>	<b>415</b>
 <p>Spiegelschrank, 3 Spiegeltüren - davon 2 trapezförmig angeordnet, 6 Glaseinlegeböden, inkl. Schalter/Steckdose, <b>seitlich und oben LED-Beleuchtung</b>, 6000 K, 17,2 W, 960 Lumen, EEK E</p> <p><i>mirror cabinet, 3 mirror doors - 2 of them are arranged in a trapeze, 6 glass shelves, incl. switch/socket, <b>lateral and top LED lighting</b>, 6000 K, 17,2 W, 960 lumen, EEC E</i></p>	80,0	68,2	17,6	<b>SDU8</b>	 <p>Dieses Produkt enthält eine Lichtquelle der Energieeffizienzklasse E</p>	<b>2238</b>
 <p>Spiegelschrank, 3 Spiegeltüren - davon 2 trapezförmig angeordnet, 6 Glaseinlegeböden, inkl. Schalter/Steckdose, <b>seitlich und oben LED-Beleuchtung</b>, 6000 K, 17,9 W, 960 Lumen, EEK E</p> <p><i>mirror cabinet, 3 mirror doors - 2 of them are arranged in a trapeze, 6 glass shelves, incl. switch/socket, <b>lateral and top LED lighting</b>, 6000 K, 17,9 W, 960 lumen, EEC E</i></p>	90,0	68,2	17,6	<b>SDU9</b>	 <p>Dieses Produkt enthält eine Lichtquelle der Energieeffizienzklasse E</p>	<b>2307</b>
 <p>Spiegelschrank, 3 beidseitig verspiegelte Türen, 4 Glaseinlegeböden, inkl. Schalter/Steckdose, seitliche LED-Beleuchtung, 6000 K, 2x 6,3 W, 2x 660 Lumen, EEK F</p> <p><i>mirror cabinet, 3 doors mirrored on both sides, 4 glass boards, incl. switch/socket lateral LED-lighting, 6000 K, 2x 6,3 W, 2x 660 lumen, EEC F</i></p>	100,0	68,2	17,6	<b>SADA10</b>	 <p>Dieses Produkt enthält eine Lichtquelle der Energieeffizienzklasse F</p>	<b>2076</b>
 <p>LED-Aufbauleuchte für Spiegelschrank mit LED-Mini-Stecker, 6000 K, 13,8 W, 1728 Lumen, EEK E</p> <p><i>LED-lighting for mirror cabinet with LED-mini-plug, 6000 K, 13,8 W, 1728 lumen, EEC E</i></p>	100,0	2,4	20,0	<b>AW100</b>	 <p>Dieses Produkt enthält eine Lichtquelle der Energieeffizienzklasse E</p>	<b>461</b>



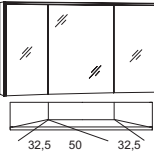







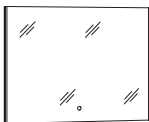





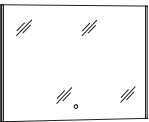

EEK/EEC=Energieeffizienzklasse/energy efficiency category  
Leuchtmittel sind nicht austauschbar / illuminants are not interchangeable.

# 3360line »Spiegelschränke/mirror cabinets«

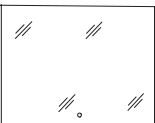
Beschreibung Description	Maße in cm Dimensions in cm			Artikel-Nr. Article no.	Türanschlag Door stop	Identnummer ID number
	B/W	H	T/D			
 <p>Spiegelschrank, 3 Spiegeltüren - davon 2 trapezförmig angeordnet, 6 Glaseinlegeböden, inkl. Schalter/Steckdose, <b>seitlich und oben LED-Beleuchtung</b>, 6000 K, 18,7 W, 960 Lumen, EEK E</p> <p><i>mirror cabinet, 3 mirror doors - 2 of them are arranged in a trapeze, 6 glass shelves, incl. switch/socket, <b>lateral and top LED lighting</b>, 6000 K, 18,7 W, 960 lumen, EEC E</i></p>	100,0	68,2	17,6	<b>SDU10</b>		<b>2376</b>
Dieses Produkt enthält eine Lichtquelle der Energieeffizienzklasse E						
 <p>Spiegelschrank, 2 beidseitig verspiegelte Türen, 4 Glaseinlegeböden, inkl. Schalter/Steckdose, seitliche LED-Beleuchtung, 6000 K, 2x 6,3 W, 2x 660 Lumen, EEK F</p> <p><i>mirror cabinet, 2 doors mirrored on both sides, 4 glass boards, incl. switch/socket lateral LED-lighting, 6000 K, 2x 6,3 W, 2x 660 lumen, EEC F</i></p>	120,0	68,2	17,6	<b>SADA12D</b>		<b>1961</b>
Dieses Produkt enthält eine Lichtquelle der Energieeffizienzklasse F						
 <p>Spiegelschrank, 3 beidseitig verspiegelte Türen, 6 Glaseinlegeböden, inkl. Schalter/Steckdose, seitliche LED-Beleuchtung, 6000 K, 2x 6,3 W, 2x 660 Lumen, EEK F</p> <p><i>mirror cabinet, 3 doors mirrored on both sides, 6 glass boards, incl. switch/socket lateral LED-lighting, 6000 K, 2x 6,3 W, 2x 660 lumen, EEC F</i></p>	120,0	68,2	17,6	<b>SADA12</b>		<b>2168</b>
Dieses Produkt enthält eine Lichtquelle der Energieeffizienzklasse F						
 <p>LED-Aufbauleuchte für Spiegelschrank mit LED-Mini-Stecker, 6000 K, 16,8 W, 2106 Lumen, EEK E</p> <p><i>LED-lighting for mirror cabinet with LED-mini-plug, 6000 K, 16,8 W, 2106 lumen, EEC E</i></p>	120,0	2,4	20,0	<b>AW120</b>		<b>485</b>
Dieses Produkt enthält eine Lichtquelle der Energieeffizienzklasse E						
 <p>Spiegelschrank, 3 Spiegeltüren - davon 2 trapezförmig angeordnet, 6 Glaseinlegeböden, inkl. Schalter/Steckdose, <b>seitlich und oben LED-Beleuchtung</b>, 6000 K, 20,3 W, 960 Lumen, EEK E</p> <p><i>mirror cabinet, 3 mirror doors - 2 of them are arranged in a trapeze, 6 glass shelves, incl. switch/socket, <b>lateral and top LED lighting</b>, 6000 K, 20,3 W, 960 lumen, EEC E</i></p>	120,0	68,2	17,6	<b>SDU12</b>		<b>2492</b>
Dieses Produkt enthält eine Lichtquelle der Energieeffizienzklasse E						







EEK/EEC=Energieeffizienzklasse/energy efficiency category  
Leuchtmittel sind nicht austauschbar / illuminants are not interchangeable.

# 3360line »Spiegelpaneele/mirror panels«

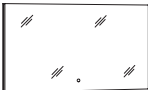
Beschreibung Description	Maße in cm Dimensions in cm			Artikel-Nr. Article no.	Türanschlag Door stop	Identnummer ID number
	B/W	H	T/D			
 <p>Spiegelpaneel, Sensorschalter, seitliche LED-Beleuchtung 6000 K, 2x 6,3 W, 2x 660 Lumen, EEK F <b>Helligkeit dimmbar</b></p> <p><i>mirror panel, sensor switch, lateral LED-lighting 6000 K, 2x 6,3 W, 2x 660 lumen, EEC F</i> <b>brighthness dimmable</b></p>	80,0	68,2	2,8	<b>SPBSA8</b>	  <p>Dieses Produkt enthält eine Lichtquelle der Energieeffizienzklasse F</p>	1154
 <p>LED-Aufbauleuchte für Spiegelpaneel mit LED-Mini-Stecker, 6000 K, 10,8 W, 1350 Lumen, EEK E <b>Helligkeit dimmbar</b></p> <p><i>LED-lighting for mirror panel with LED-mini-plug, 6000 K, 10,8 W, 1350 lumen, EEC E</i> <b>brighthness dimmable</b></p>	80,0	2,4	10,0	<b>AWP80</b>	  <p>Dieses Produkt enthält eine Lichtquelle der Energieeffizienzklasse E</p>	370
 <p>Spiegelpaneel, Sensorschalter, seitliche LED-Beleuchtung 6000 K, 2x 6,3 W, 2x 660 Lumen, EEK F <b>Helligkeit dimmbar</b></p> <p><i>mirror panel, sensor switch, lateral LED-lighting 6000 K, 2x 6,3 W, 2x 660 lumen, EEC F</i> <b>brighthness dimmable</b></p>	90,0	68,2	2,8	<b>SPBSA9</b>	  <p>Dieses Produkt enthält eine Lichtquelle der Energieeffizienzklasse F</p>	1200
 <p>LED-Aufbauleuchte für Spiegelpaneel mit LED-Mini-Stecker, 6000 K, 12,5 W, 1566 Lumen, EEK E <b>Helligkeit dimmbar</b></p> <p><i>LED-lighting for mirror panel with LED-mini-plug, 6000 K, 12,5 W, 1566 lumen, EEC E</i> <b>brighthness dimmable</b></p>	90,0	2,4	10,0	<b>AWP90</b>	  <p>Dieses Produkt enthält eine Lichtquelle der Energieeffizienzklasse E</p>	392
 <p>Spiegelpaneel, Sensorschalter, seitliche LED-Beleuchtung 6000 K, 2x 6,3 W, 2x 660 Lumen, EEK F <b>Helligkeit dimmbar</b></p> <p><i>mirror panel, sensor switch, lateral LED-lighting 6000 K, 2x 6,3 W, 2x 660 lumen, EEC F</i> <b>brighthness dimmable</b></p>	100,0	68,2	2,8	<b>SPBSA10</b>	  <p>Dieses Produkt enthält eine Lichtquelle der Energieeffizienzklasse F</p>	1246
 <p>LED-Aufbauleuchte für Spiegelpaneel mit LED-Mini-Stecker, 6000 K, 13,7 W, 1440 Lumen, EEK F <b>Helligkeit dimmbar</b></p> <p><i>LED-lighting for mirror panel with LED-mini-plug, 6000 K, 13,7 W, 1440 lumen, EEC F</i> <b>brighthness dimmable</b></p>	100,0	2,4	10,0	<b>AWP100</b>	  <p>Dieses Produkt enthält eine Lichtquelle der Energieeffizienzklasse F</p>	415

EEK/EEC=Energieeffizienzklasse/energy efficiency category  
Leuchtmittel sind nicht austauschbar / illuminants are not interchangeable.









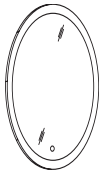

# 3360line »Spiegelpaneele/mirror panels«

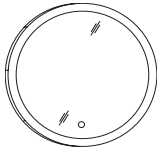
Beschreibung Description	Maße in cm Dimensions in cm			Artikel-Nr. Article no.	Türanschlag Door stop	Identnummer ID number
	B/W	H	T/D			
 <p>Spiegelpaneel, Sensorschalter, seitliche LED-Beleuchtung 6000 K, 2x 6,3 W, 2x 660 Lumen, EEK F <b>Helligkeit dimmbar</b></p> <p><i>mirror panel, sensor switch, lateral LED-lighting 6000 K, 2x 6,3 W, 2x 660 lumen, EEC F</i> <b>brighness dimmable</b></p>	120,0	68,2	2,8	<b>SPBSA12</b>	  <p>Dieses Produkt enthält eine Lichtquelle der Energieeffizienzklasse F</p>	<b>1292</b>
 <p>LED-Aufbauleuchte für Spiegelpaneel mit LED-Mini-Stecker, 6000 K, 17,3 W, 2160 Lumen, EEK E <b>Helligkeit dimmbar</b></p> <p><i>LED-lighting for mirror panel with LED-mini-plug, 6000 K, 17,3 W, 2160 lumen, EEC E</i> <b>brighness dimmable</b></p>	120,0	2,4	10,0	<b>AWP120</b>	  <p>Dieses Produkt enthält eine Lichtquelle der Energieeffizienzklasse E</p>	<b>439</b>

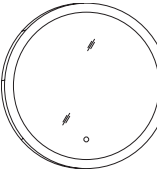
EEK/EEC=Energieeffizienzklasse/energy efficiency category  
Leuchtmittel sind nicht austauschbar / illuminants are not interchangeable.

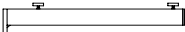

# 3360line »Spiegelpaneele und Zubehör/ mirror panels and accessoires«

Beschreibung Description	Maße in cm Dimensions in cm			Artikel-Nr. Article no.	Türanschlag Door stop	Identnummer ID number
	B/W	H	T/D			
 <p>Spiegelpaneel, Sensorschalter, satiniert, LED Beleuchtung, 4000 K, 17,3 W, 2415 Lumen, EEK G <b>Helligkeit dimmbar</b></p> <p><i>mirror panel, sensor switch, satined, LED-lighting, 4000 K, 17,3 W, 2415 lumen, EEC G</i> <b>brighness dimmable</b></p>	55,0	78,0	2,8	<b>SPE55</b>	  <p>Dieses Produkt enthält eine Lichtquelle der Energieeffizienzklasse G</p>	1131
 <p>Spiegelpaneel, Sensorschalter, satiniert, LED Beleuchtung, 4000 K, 13,5 W, 1890 Lumen, EEK G <b>Helligkeit dimmbar</b></p> <p><i>mirror panel, sensor switch, satined, LED-lighting, 4000 K, 13,5 W, 1890 lumen, EEC G</i> <b>brighness dimmable</b></p>	55,0	55,0	2,8	<b>SPK55</b>	  <p>Dieses Produkt enthält eine Lichtquelle der Energieeffizienzklasse G</p>	992
 <p>Spiegelpaneel, Sensorschalter, satiniert, LED Beleuchtung, 4000 K, 20,8 W, 2905 Lumen, EEK G <b>Helligkeit dimmbar</b></p> <p><i>mirror panel, sensor switch, satined, LED-lighting, 4000 K, 20,8 W, 2905 lumen, EEC G</i> <b>brighness dimmable</b></p>	78,0	78,0	2,8	<b>SPK78</b>	  <p>Dieses Produkt enthält eine Lichtquelle der Energieeffizienzklasse G</p>	1292
 <p>Waschtischkonsole mit Handtuchhalter, verchromt</p> <p><i>washbasin console with towel rail, chrome-plated</i></p>	4,0	15,0	45,0	<b>HK45</b>		397
 <p>Waschtischkonsole Stahlrohr 4 x 4 cm</p> <p><i>washbasin mounting bracket steel 4 x 4 cm</i></p>	4,0	4,0	39,2	<b>WK</b>		148
 <p>Steckdose/Powerbox für Spiegelschränke Ausführung <b>Schweiz</b> IP44 mit USB-C Stecker</p> <p><i>Power socket for mirror cabinets Switzerland type IP44 with USB-C plug</i></p>				<b>Mehrpreis extra charge</b>		138
 <p>Steckdose/Powerbox für Spiegelschränke Ausführung <b>Frankreich</b> mit USB-C Stecker</p> <p><i>Power socket for mirror cabinets France type with USB-C plug</i></p>				<b>Mehrpreis extra charge</b>		138

EEK/EEC=Energieeffizienzklasse/energy efficiency category  
Leuchtmittel sind nicht austauschbar / illuminants are not interchangeable.

**i** Weiteres Zubehör finden Sie im Register 3970 und Beistellschränke im Register 3990.  
**Further accessoires can be found in register 3970 and side cabinets in register 3990.**

# 3360line »Maße/dimensions«

Bohrlochhöhen für Schraubhaken, Anschlussmaße und Abflusshöhen/drilling point for screw hooks, dimensions for mounting and drain

Bei Montage ohne Unterschrank sind 2 Konsolen (WK oder HK45) erforderlich. Bei Montage mit einem Unterschrank, nur auf einer Seite, ist eine Konsole (WK oder HK45) auf der gegenüberliegenden Seite erforderlich.

2 brackets (WK or HK45) are required for installation without base unit. When mounting with a base cabinet, on one side only, a console (WK or HK45) is required on the opposite side.

INGA/WTFI8M  
WTFI8M

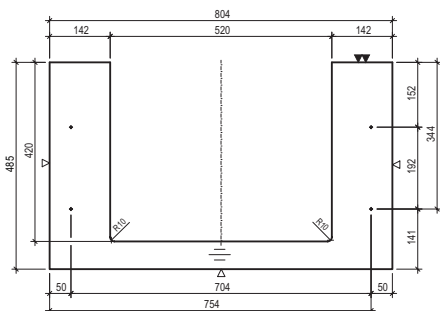

INGA/WTFI12L  
WTFI12L

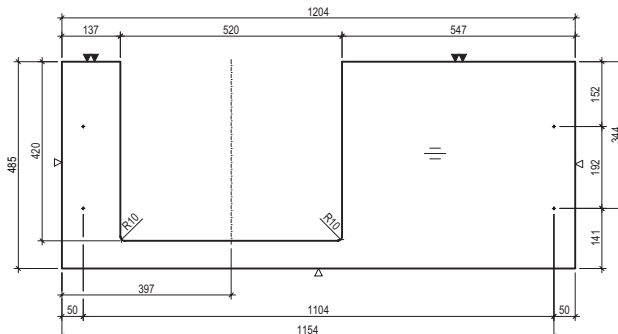

INGA/WTFI12M  
WTFI12M

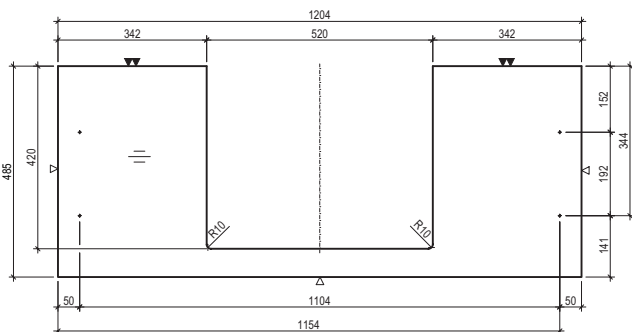

INGA/WTFI12R  
WTFI12R

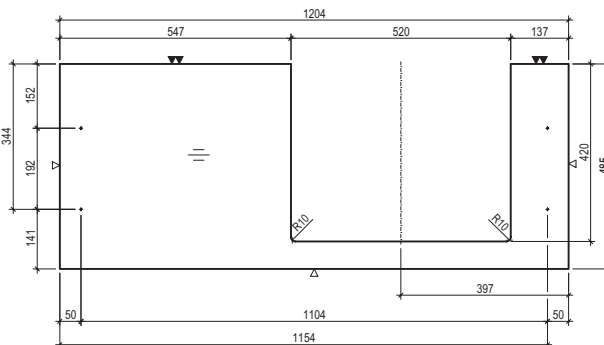

BELLA/WTFB8M  
WTPB8M

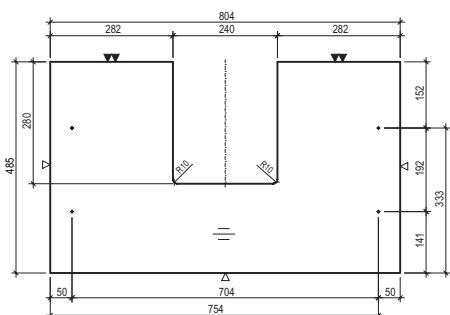

BELLA/WTFB12L  
WTPB12L

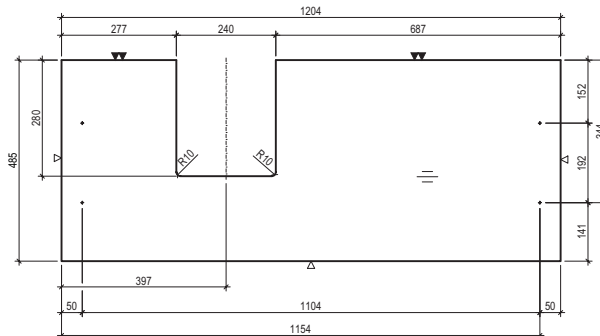

BELLA/WTFB12M  
WTPB12M

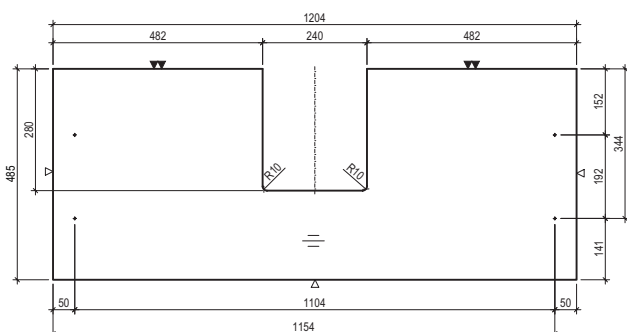

BELLA/WTFB12R  
WTPB12R

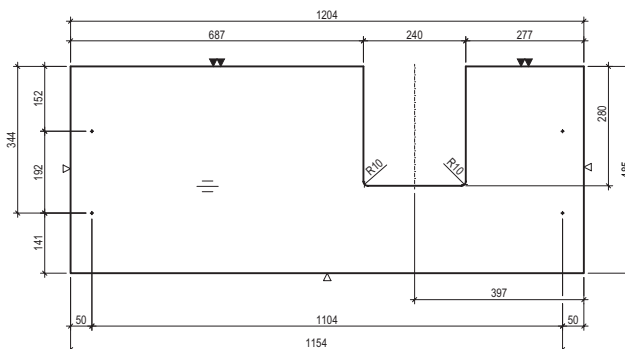

Achtung: Die Montage muss durch fachkundige Personen erfolgen. Der Untergrund zur Wandbefestigung ist vor Montage zu prüfen. Bitte wählen Sie entsprechend das geeignete Befestigungsmaterial. Fehlerhafte Montagen können das Möbel beschädigen oder dessen Funktion dauerhaft beeinträchtigen. Für Sach- und Personenschäden übernehmen wir im Falle einer unsachgemäßen Montage keine Haftung.

Attention: Assembly must be carried out by skilled personnel. The subsurface for the wall mounting must be checked before assembly. Please select a suitable mounting material. Faulty assembly can damage furniture or permanently impair its function. We will not be held responsible for damage to material or persons in the case of improper assembly.

# 3360line »Maße/dimensions«

Bohrlochhöhen für Schraubhaken, Anschlussmaße und Abflusshöhen/drilling point for screw hooks, dimensions for mounting and drain

Bei Montage ohne Unterschrank sind 2 Konsolen (WK oder HK45) erforderlich. Bei Montage mit einem Unterschrank, nur auf einer Seite, ist eine Konsole (WK oder HK45) auf der gegenüberliegenden Seite erforderlich.

2 brackets (WK or HK45) are required for installation without base unit. When mounting with a base cabinet, on one side only, a console (WK or HK45) is required on the opposite side.



POCO/WTFP8M  
WTPP8M

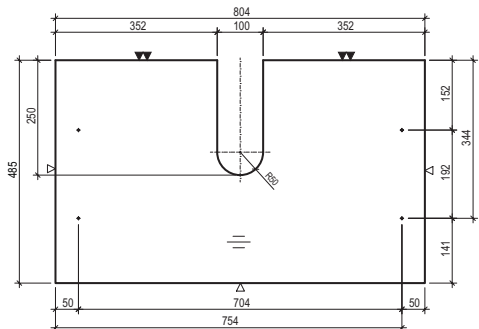

POCO/WTFP12L  
WTPP12L

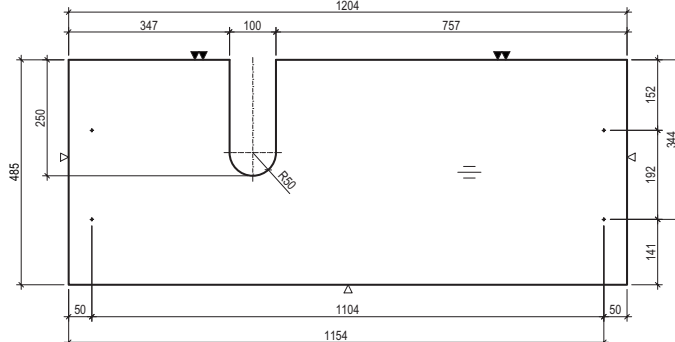

POCO/WTFP12M  
WTPP12M

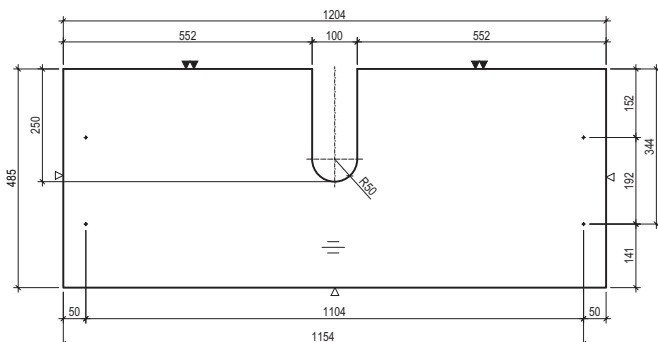

POCO/WTFP12R  
WTPP12R

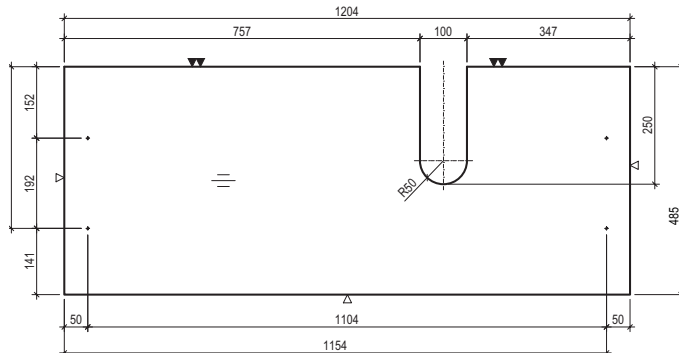

RUMBA/WTFA8M  
WTPA8M

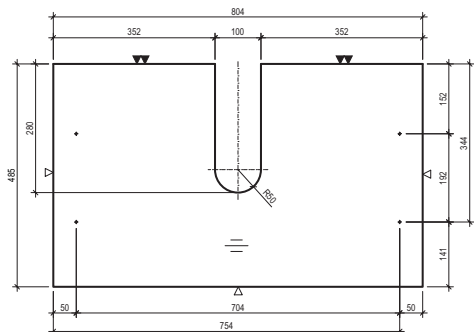

RUMBA/WTFA12L  
WTPA12L

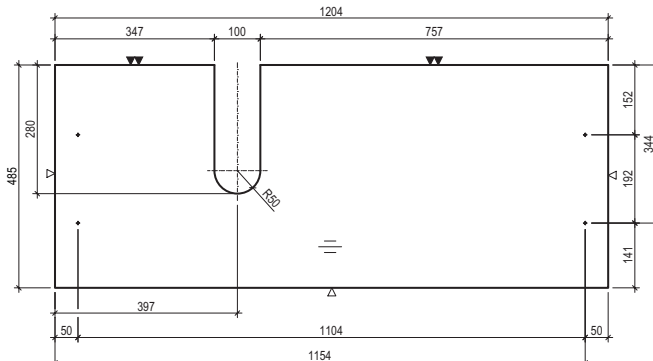

RUMBA/WTFA12M  
WTPA12M

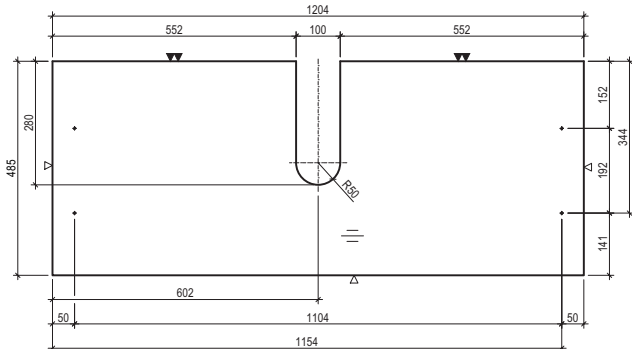

RUMBA/WTFA12R  
WTPA12R

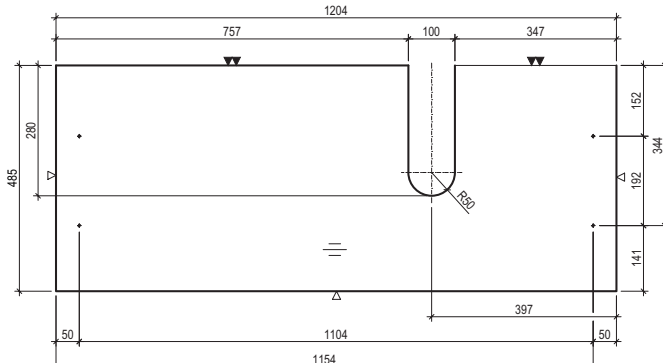

**!** Achtung: Die Montage muss durch fachkundige Personen erfolgen. Der Untergrund zur Wandbefestigung ist vor Montage zu prüfen. Bitte wählen Sie entsprechend das geeignete Befestigungsmaterial. Fehlerhafte Montagen können das Möbel beschädigen oder dessen Funktion dauerhaft beeinträchtigen. Für Sach- und Personenschäden übernehmen wir im Falle einer unsachgemäßen Montage keine Haftung.  
Attention: Assembly must be carried out by skilled personnel. The subsurface for the wall mounting must be checked before assembly. Please select a suitable mounting material. Faulty assembly can damage furniture or permanently impair its function. We will not be held responsible for damage to material or persons in the case of improper assembly.





# 3390line





# »3390line«

## Piktogramme/pictograms



Mineralmarmor Waschtisch  
Marble minerals washbasin



LED Lichtfarbe kalt  
LED colour temperature cold

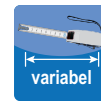

Waschtischplatte maßvariabel  
washbasin plate with variable size



Keramik Waschtisch  
Ceramic washbasin



LED Lichtfarbe warm  
LED colour temperature warm



LED mit Sensorschalter,  
Helligkeit dimmbar  
LED with sensor switch,  
brightness dimmable



Waschtischplatte freihängend?  
Konsolle bestellen! (Seite 24)  
Washbasin plate without base-unit?  
Include a console! (page 24)

## Mineralmarmor Waschbecken weiß alpin Glanz (FG69) Marble minerals on-top washbasin gloss alpine white (FG69)

≈ Beckenmaße in cm (BxHxD)  
basin dimensions in cm (WxHxD)

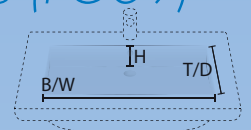

### Inga



MWING6 | 57 x 12 x 31 cm



Detail

## Keramik Waschbecken weiß alpin Glanz (FGK) Ceramic on-top washbasin gloss alpine white (FGK)



### Bella



KWBEL7 | 69 x 11 x 29 cm



Detail



### Poco



KWPOC55 | 50 x 11 x 30 cm



Detail



### Rumba



KWAWG6 | 59,6 x 9,9 x 32,7 cm



**Weiß Glanz**  
Gloss White  
FGK

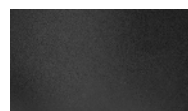

**Schwarz Matt**  
Matt Black  
FGKB



Detail

## Waschtischplattenfarben/washbasin plate colours

19 mm Plattenstärke/plate thickness

PG 1

PG 2



**Eiche Struktur Natur Nachbildung**  
*Oak Structure Nature Finish*  
FG55



**Eiche Struktur Braun Nachbildung** NEW  
*Oak Structure Brown Finish*  
FG70



**Query Steindekor**  
*Query Stone Decor*  
FG92



**Nature Steindekor**  
*Nature Stone Decor*  
FG93

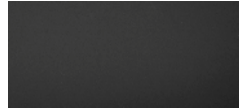

**Schwarz Supermatt**  
*Black Super Matt*  
FG88  
**Anti-Fingerprint-Beschichtung**  
*Anti-Fingerprint coating*

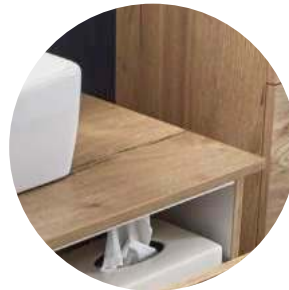

## Waschtischplattenfarben/washbasin plate colours

38 mm Plattenstärke/plate thickness



**Eiche Struktur Natur Nachbildung**  
*Oak Structure Nature Finish*  
FG55

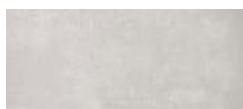

**Polaris**  
*Polaris*  
FG96



**Prado Achatgrau**  
*Prado Achatgrey*  
FG97





# »3390line«

## Schränke/cabinets 3390line

### Frontfarben/front colours

#### Dickkante/thick edge

286



**Weiß Seidenglanz**  
*Silk Gloss White*  
FGE\_

284



**Anthrazit Seidenglanz**  
*Silk Gloss Anthracite*  
FGA\_

490



**Kastanie Graphit Nachbildung**  
*Graphite Chestnut Finish*  
FGC\_

473



**Eiche Struktur Natur Nachbildung**  
*Oak Structure Nature Finish*  
FGM\_

435



**Eiche Struktur Weiß Nachbildung**  
*Oak Structure White Finish*  
FGL\_

426



**Eiche Struktur Braun Nachbildung**  
*Oak Structure Brown Finish*  
FGH\_

### Korpusfarben/basic shell colours

#### PG 1 Dickkante/thick edge

286



**Weiß Seidenglanz**  
*Silk Gloss White*  
E/FG86

284



**Anthrazit Seidenglanz**  
*Silk Gloss Anthracite*  
A/FG84

490



**Kastanie Graphit Nachbildung**  
*Graphite Chestnut Finish*  
C/FG45

473



**Eiche Struktur Natur Nachbildung**  
*Oak Structure Nature Finish*  
M/FG55

435



**Eiche Struktur Weiß Nachbildung**  
*Oak Structure White Finish*  
L/FG40

426



**Eiche Struktur Braun Nachbildung**  
*Oak Structure Brown Finish*  
H/FG70

# »3390line«

## Regalfarben/ shelf colours

 <b>287</b>	<b>Weiß Seidenglanz</b> <i>Silk Gloss White</i> FG86	 <b>285</b>	<b>Anthrazit Seidenglanz</b> <i>Silk Gloss Anthracite</i> FG84
 <b>491</b>	<b>Kastanie Graphit Nachbildung</b> <i>Graphite Chestnut Finish</i> FG45	 <b>474</b>	<b>Eiche Struktur Natur Nachbildung</b> <i>Oak Structure Nature Finish</i> FG55
 <b>436</b>	<b>Eiche Struktur Weiß Nachbildung</b> <i>Oak Structure White Finish</i> FG40	 <b>427</b>	<b>Eiche Struktur Braun Nachbildung</b> <i>Oak Structure Brown Finish</i> FG70

## Griffleiste/ handle bar



**Aluminium Matt**  
*Matt aluminium*

## Beleuchtung / lighting



**Aufbauleuchte LED**  
*Top light LED*



**Seitlich und oben LED Beleuchtung**  
*lateral and top LED lighting*

### Lichfarbe Tageslicht (Kalt)

*Luminous colour natural light (cold)*











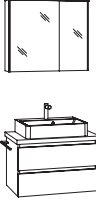





AW80, AWP80,  
AWP90,  
AW100, AWP100  
AW120, AWP120

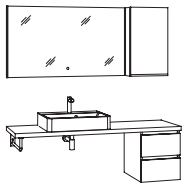

Die Steckdose / Powerbox für Spiegelschränke ist auch in Ausführung für die Schweiz / Frankreich erhältlich. Bitte Mehrpreis beachten (siehe Seite 24).  
The power socket for mirror cabinets is also available for Switzerland / France. Please note extra charge (see page 24).

# 3390line »Beispiel-Kombinationen/example-combinations«

Beschreibung Description	Maße in cm Dimensions in cm			Artikel-Nr. Article no.	Türanschlag Door stop	Identnummer ID number
	B/W	H	T/D			
 <p>Kombination 80 cm bestehend aus: LED-Aufbauleuchte 80 cm Spiegelschrank, 2 Spiegeltüren 80 cm Aufsatz-Mineralmarmor-Waschbecken Inga Waschtischplatte 38 mm (Breite 80cm) Waschtisch-Unterschrank 77 cm Handtuchhalter Handtuchhalter</p> <p><i>combination 80 cm width consisting of: LED top lighting 80 cm mirror cabinet, 2 mirror doors 80 cm on-top marble minerals washbasin Inga washbasin plate 38 mm (width 80cm) washbasin base cabinet 77 cm towel rail towel rail</i></p>				AW80 SADA8L MWING6 WTP18M GWPWSA7 HHF133 HHF133	  	PG1  415 1707 1038 485 1476 102 102 <hr/> 5325
 <p>Kombination 120 cm bestehend aus: LED-Aufbauleuchte 80cm Spiegelschrank, 2 Spiegeltüren 80 cm Aufsatz-Keramik-Waschbecken Poco Waschtischplatte 38 mm (Breite 120 cm) Waschtisch-Unterschrank 117 cm</p> <p><i>combination 120 cm width consisting of: LED top lighting 80 cm mirror cabinet, 2 mirror doors 80 cm on-top ceramic washbasin Poco washbasin plate 38mm (width 120 cm) washbasin base cabinet 117 cm</i></p>				AW80 SADA8L KWPOC55 WTPP12L GWPWSA11L	  	415 1707 646 670 1730 <hr/> 5168
 <p>Kombination ca. 160 cm bestehend aus: Spiegelpaneel, Sensorschalter 55cm Spiegelpaneel, Sensorschalter 55cm Aufsatz-Keramik-Waschbecken Poco Aufsatz-Keramik-Waschbecken Poco Variable Waschtischplatte 19mm <b>aus PG1</b> (Breite 154,4 cm) Waschtisch-Unterschrank 77cm Waschtisch-Unterschrank 77cm</p> <p><i>combination ca. 160 cm width consisting of: mirror panel, sensor switch 55 cm mirror panel, sensor switch 55 cm on-top ceramic washbasin Poco on-top ceramic washbasin Poco variable washbasin plate 19 mm <b>from PG1</b> (width 154,4 cm) washbasin base cabinet 77cm washbasin base cabinet 77cm</i></p>				SPE55 SPE55 KWPOC55 KWPOC55 WTFV10 GWPWSA7 GWPWSA7	     	1131 1131 646 646 1152 1476 1476 <hr/> 7658  <b>Waschtischplattenfarbe aus PG1 washbasin plate colour from PG1</b>
 <p>Kombination 130 cm bestehend aus: Spiegelpaneel, Sensorschalter 90 cm Oberschrank, 1 Tür 40 cm Aufsatz-Keramik-Waschbecken Rumba weiß Variable Waschtischplatte 38 mm (Breite 130 cm) Unterschrank, 2 Auszüge 40 cm Designsiphon Waschtischkonsole mit Handtuchhalter</p> <p><i>combination 130 cm width consisting of: mirror panel, sensor switch 90 cm top cabinet, 1 door 40 cm on-top ceramic washbasin Rumba white variable washbasin plate 38 mm (width 130 cm) base cabinet, 2 extensions 40 cm design siphon washbasin console with towel rail</i></p>				SPBSA9 GOT40DR KAWAWG6 WTPV10 GUWAAA4 DS HK45	     	1200 485 1107 936 1038 236 397 <hr/> 5399

Handtuchhalter, Regale, Unterbauleuchtungen und weiteres Zubehör finden Sie in der Rubrik 3970zubehör.  
Towel rails, shelves, base lightings and other accessories can be found in the 3970accessories range.

# 3390line »Waschtische/washbasins«

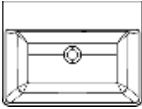
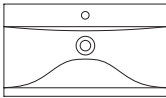
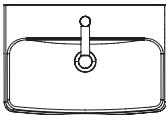
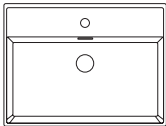
Beschreibung Description	Maße in cm Dimensions in cm			Artikel-Nr. Article no.	Waschtisch Washbasin	Identnummer ID number	
	B/W	H	T/D				
 <p>Aufsatz-Mineralmarmor-Waschtisch inkl. Überlaufgarnitur und Montageset MONK-4</p> <p><i>on-top marble minerals washbasin incl. overflow and mounting-set MONK-4</i></p>	60,0	12,0	45,0	<b>MWING6</b>	<b>INGA</b>	<b>1038</b>	
 <p>Aufsatz-Keramik-Waschtisch inkl. Überlauf und Montageset MONK-4</p> <p><i>on-top ceramic washbasin incl. overflow and mounting-set MONK-4</i></p>	71,0	16,0	44,5	<b>KWBEL7</b>	<b>BELLA</b>	<b>900</b>	
 <p>Aufsatz-Keramik-Waschtisch inkl. Überlauf und Montageset MONK-4</p> <p><i>on-top ceramic washbasin incl. overflow and mounting-set MONK-4</i></p>	56,0	15,0	38,0	<b>KWPOC55</b>	<b>POCO</b>	<b>646</b>	
 <p>Aufsatz-Keramik-Waschtisch inkl. Überlauf und Montageset MONK-4</p> <p><i>on-top ceramic washbasin incl. overflow and mounting-set MONK-4</i></p>	61,2	12,0	46,6	<b>KWAWG6</b>	<b>RUMBA</b>	<b>FGK</b> Weiß Glanz/ <i>gloss white</i>	<b>FGKB</b> Schwarz Matt/ <i>matt black</i>
						<b>1107</b>	<b>1384</b>









BITTE BEACHTEN: Sehen Sie die unterschiedlichen Maße der Waschtischplattenfräsungen auf Seite 25 - 26  
PLEASE NOTE: see the different dimensions of the washbasin plate notchs on page 25 - 26

# 3390line »Waschtischplatten 19mm/washbasin plates 19mm«



Beschreibung Description	Maße in cm Dimensions in cm			Artikel-Nr. Article no.	Waschtisch Washbasin	Identnummer ID number	
	B/W	H	T/D			PG 1	PG 2

Die Waschtischkonsole WK finden Sie auf Seite 24  
The washbasin console WK can be found on page 24

 <p>Waschtischplatte inkl. Ausfräsung mittig Fixmaß, Plattenstärke 19mm</p> <p>Washbasin plate <b>with central notch</b> fixed size, plate thickness 19mm</p>	80,4	1,9	48,5	WTFI8M	INGA	461	692
				WTFB8M	BELLA		
				WTFP8M	POCO		
				WTFA8M	RUMBA		
 <p>Waschtischplatte inkl. Ausfräsung mittig Fixmaß, Plattenstärke 19mm</p> <p>Washbasin plate <b>with central notch</b> fixed size, plate thickness 19mm</p>	100,4	1,9	48,5	WTFI10M	INGA	554	830
				WTFB10M	BELLA		
				WTFP10M	POCO		
				WTFA10M	RUMBA		
 <p>Waschtischplatte inkl. Ausfräsung links Fixmaß, Plattenstärke 19mm</p> <p>Washbasin plate <b>with notch left</b> fixed size, plate thickness 19mm</p>	120,4	1,9	48,5	WTFI12L	INGA	646	969
				WTFB12L	BELLA		
				WTFP12L	POCO		
				WTFA12L	RUMBA		
 <p>Waschtischplatte inkl. Ausfräsung rechts Fixmaß, Plattenstärke 19mm</p> <p>Washbasin plate <b>with notch right</b> fixed size, plate thickness 19mm</p>	120,4	1,9	48,5	WTFI12R	INGA	646	969
				WTFB12R	BELLA		
				WTFP12R	POCO		
				WTFA12R	RUMBA		
 <p>Waschtischplatte inkl. Ausfräsung mittig Fixmaß, Plattenstärke 19mm</p> <p>Washbasin plate <b>with central notch</b> fixed size, plate thickness 19mm</p>	120,4	1,9	48,5	WTFI12M	INGA	646	969
				WTFB12M	BELLA		
				WTFP12M	POCO		
				WTFA12M	RUMBA		
 <p>Waschtischplatte ohne Ausfräsung Fixmaß, Plattenstärke 19mm</p> <p>Washbasin plate <b>without notch</b> fixed size, plate thickness 19mm</p>	80,4	1,9	48,5	WTF8		439	670
	100,4	1,9	48,5	WTF10		530	808
	120,4	1,9	48,5	WTF12		623	946
 <p>Waschtischplatte ohne Ausfräsung Variables Maß, Plattenstärke 19mm Die Platte kann in cm-Schritten von 80,0 - 200,4 cm individuell bestellt werden</p> <p>Washbasin plate <b>without notch</b> variable size, plate thickness 19mm The plate can be moved in cm steps from 80,0 - 200,4 cm be ordered individually</p>	10,0	1,9	48,5	WTFV10		72	106
							Preis pro angefangene 10 cm Price per 10 cm or part thereof
<p>Bei Planung mit Unterschränken empfehlen wir einen seitlichen Überstand von mindestens 0,2 cm auf jeder Seite zu berücksichtigen. When planning with base units we recommend considering an overhang of at least 0.2 cm on each side.</p>							

**i** Waschtischplattenfarben unbedingt mit angeben, Übersicht siehe Seite 2 / Please indicate washbasin plate colours, overview see page 2  
Die Ausfräsungen sind beispielhaft, weitere Informationen auf den Seiten 25 - 26 / The notches are exemplary, further information on pages 25 - 26

# 3390line »Waschtischplatten 38mm/washbasin plates 38mm«



Beschreibung Description	Maße in cm Dimensions in cm			Artikel-Nr. Article no.	Waschtisch Washbasin	Identnummer ID number
	B/W	H	T/D			

Die Waschtischkonsole WK finden Sie auf Seite 24  
The washbasin console WK can be found on page 24

<p>Waschtischplatte inkl. Ausfräsung mittig Fixmaß, Plattenstärke 38mm</p> <p>Washbasin plate with central notch fixed size, plate thickness 38mm</p>	80,4	3,8	48,5	WTP18M	INGA	485
				WTPB8M	BELLA	
				WTPP8M	POCO	
				WTPA8M	RUMBA	
<p>Waschtischplatte inkl. Ausfräsung mittig Fixmaß, Plattenstärke 38mm</p> <p>Washbasin plate with central notch fixed size, plate thickness 38mm</p>	100,4	3,8	48,5	WTP110M	INGA	577
				WTPB10M	BELLA	
				WTPP10M	POCO	
				WTPA10M	RUMBA	
<p>Waschtischplatte inkl. Ausfräsung links Fixmaß, Plattenstärke 38mm</p> <p>Washbasin plate with notch left fixed size, plate thickness 38mm</p>	120,4	3,8	48,5	WTP112L	INGA	670
				WTPB12L	BELLA	
				WTPP12L	POCO	
				WTPA12L	RUMBA	
<p>Waschtischplatte inkl. Ausfräsung rechts Fixmaß, Plattenstärke 38mm</p> <p>Washbasin plate with notch right fixed size, plate thickness 38mm</p>	120,4	3,8	48,5	WTP112R	INGA	670
				WTPB12R	BELLA	
				WTPP12R	POCO	
				WTPA12R	RUMBA	
<p>Waschtischplatte inkl. Ausfräsung mittig Fixmaß, Plattenstärke 38mm</p> <p>Washbasin plate with central notch fixed size, plate thickness 38mm</p>	120,4	3,8	48,5	WTP112M	INGA	670
				WTPB12M	BELLA	
				WTPP12M	POCO	
				WTPA12M	RUMBA	

<p>Waschtischplatte ohne Ausfräsung Fixmaß, Plattenstärke 38mm</p> <p>Washbasin plate without notch fixed size, plate thickness 38mm</p>	80,4	3,8	48,5	WTP8		461
	100,4	3,8	48,5	WTP10		554
	120,4	3,8	48,5	WTP12		646

<p>Waschtischplatte ohne Ausfräsung Variables Maß, Plattenstärke 38mm Die Platte kann in cm-Schritten von 80,0 - 200,4 cm individuell bestellt werden</p> <p>Washbasin plate without notch variable size, plate thickness 38mm The plate can be moved in cm steps from 80,0 - 200,4 cm be ordered individually</p>	10,0	3,8	48,5	<p>variabel</p>		72
						Preis pro angefangene 10cm Price per 10cm or part thereof
<p>Bei Planung mit Unterschränken empfehlen wir einen seitlichen Überstand von mindestens 0,2 cm auf jeder Seite zu berücksichtigen. When planning with base units we recommend considering an overhang of at least 0.2 cm on each side.</p>						

**i** Waschtischplattenfarben unbedingt mit angeben, Übersicht siehe Seite 2 / Please indicate washbasin plate colours, overview see page 2  
Die Ausfräsungen sind beispielhaft, weitere Informationen auf den Seiten 25 - 26 / The notches are exemplary, further information on pages 25 - 26

# 3390line »Unter- und Oberschrank-Regale variabel / base & wall unit shelves variable«

Beschreibung Description	Maße in cm Dimensions in cm			Artikel-Nr. Article no.	Türanschlag Door stop	Identnummer ID number
	B/W	H	T/D			

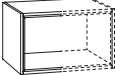
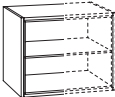



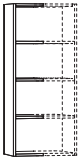





	Unterschrankregal variabel 1 offenes Einschubfach, inkl. Aufhängung <i>base cabinet shelf variable 1 open case, incl. hanging brackets</i>	15,0 - 60,0	23,8	46,0	RFAV6	575
	Unterschrankregal variabel 1 offenes Einschubfach, inkl. Aufhängung <i>base cabinet shelf variable 1 open case, incl. hanging brackets</i>	15,0 - 60,0	36,6	46,0	RFBV6	671
	Unterschrankregal variabel 1 offenes Einschubfach, 1 fester Einlege- boden, inkl. Aufhängung <i>base cabinet shelf variable 1 open case, 1 fixed shelf incl. hanging brackets</i>	15,0 - 60,0	47,8	46,0	RFCV6	767

**BITTE BEACHTEN:** Das Unterschrankregal und das offene Einschubfach können in voneinander abweichenden Dekoren bestellt werden.  
**PLEASE NOTE:** The base cabinet shelf and the open case can be ordered in different colours.







	Oberschrankregal für Spiegelschrank/- paneel 3 feste Einlegeböden, inkl. Aufhängung <b>Bei Bestellung Breite des Regals angeben!</b>  <i>wall unit shelf for mirror cabinet/- panel 3 fixed shelves, incl. mounting hange When ordering, please state the width of the shelf!</i>	15,0 - 60,0	68,2	15,6	REBV	769
--	--	----------------	------	------	------	-----

Die Regale können in cm-Schritten von 15-60 cm Breite individuell bestellt werden / *the shelves can be ordered in cm steps from 15-60 cm wide*

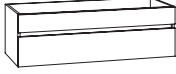
 Regalfarben unbedingt mit angeben, Übersicht siehe Seite 4. *Please indicate shelf colours, overview see page 4.*

Beschreibung <i>Description</i>	Maße in cm <i>Dimensions in cm</i>			Artikel-Nr. <i>Article no.</i>	Türanschlag <i>Door stop</i>	Identnummer <i>ID number</i>
	B/W	H	T/D			
 Waschtisch-Unterschrank mit Siphon-Ausschnitt mittig, 1 Schubkasten <i>washbasin base cabinet with siphon-cutout center, 1 drawer</i>	77,0	23,8	48,0	GWPWS7		PG1 1016
 Waschtisch-Unterschrank mit Siphon-Ausschnitt mittig, 2 Schubkästen <i>washbasin base cabinet with siphon-cutout center, 2 drawers</i>	77,0	36,6	48,0	GWPWSS7		1246
 Waschtisch-Unterschrank mit Siphon-Ausschnitt mittig, 1 Schubkasten, 1 Auszug <i>washbasin base cabinet with siphon-cutout center, 1 drawer, 1 extension</i>	77,0	47,8	48,0	GWPWSA7		1476
 Waschtisch-Unterschrank mit Siphon-Ausschnitt mittig, 2 Schubkästen, 1 Auszug <i>washbasin base cabinet with siphon-cutout center, 2 drawers, 1 extension</i>	77,0	60,6	48,0	GWPWSSA7		1753
 Waschtisch-Unterschrank mit Siphon-Ausschnitt mittig, 1 Schubkasten <i>washbasin base cabinet with siphon-cutout center, 1 drawer</i>	97,0	23,8	48,0	GWPWS9		1085
 Waschtisch-Unterschrank mit Siphon-Ausschnitt mittig, 2 Schubkästen <i>washbasin base cabinet with siphon-cutout center, 2 drawers</i>	97,0	36,6	48,0	GWPWSS9		1338
 Waschtisch-Unterschrank mit Siphon-Ausschnitt mittig, 1 Schubkasten, 1 Auszug <i>washbasin base cabinet with siphon-cutout center, 1 drawer, 1 extension</i>	97,0	47,8	48,0	GWPWSA9		1615
 Waschtisch-Unterschrank mit Siphon-Ausschnitt mittig, 2 Schubkästen, 1 Auszug <i>washbasin base cabinet with siphon-cutout center, 2 drawers, 1 extension</i>	97,0	60,6	48,0	GWPWSSA9		1915
 Waschtisch-Unterschrank mit Siphon-Ausschnitt links, 1 Schubkasten <i>washbasin base cabinet with siphon-cutout left, 1 drawer</i>	117,0	23,8	48,0	GWPWS11L		1131
 Waschtisch-Unterschrank mit Siphon-Ausschnitt rechts, 1 Schubkasten <i>washbasin base cabinet with siphon-cutout right, 1 drawer</i>	117,0	23,8	48,0	GWPWS11R		1131
 Waschtisch-Unterschrank mit Siphon-Ausschnitt mittig, 1 Schubkasten <i>washbasin base cabinet with siphon-cutout center, 1 drawer</i>	117,0	23,8	48,0	GWPWS11M		1131













	Beschreibung <i>Description</i>	Maße in cm <i>Dimensions in cm</i>			Artikel-Nr. <i>Article no.</i>	Türanschlag <i>Door stop</i>	Identnummer <i>ID number</i>
		B/W	H	T/D			
							PG1
	Waschtisch-Unterschrank <b>mit Siphon-Ausschnitt links</b> , 2 Schubkästen <i>washbasin base cabinet with siphon-cutout left, 2 drawers</i>	117,0	36,6	48,0	GWPWSS11L		1522
	Waschtisch-Unterschrank <b>mit Siphon-Ausschnitt rechts</b> , 2 Schubkästen <i>washbasin base cabinet with siphon-cutout right, 2 drawers</i>	117,0	36,6	48,0	GWPWSS11R		1522
	Waschtisch-Unterschrank <b>mit Siphon-Ausschnitt mittig</b> , 2 Schubkästen <i>washbasin base cabinet with siphon-cutout center, 2 drawers</i>	117,0	36,6	48,0	GWPWSS11M		1522
	Waschtisch-Unterschrank <b>mit Siphon-Ausschnitt links</b> , 1 Schubkasten, 1 Auszug <i>washbasin base cabinet with siphon-cutout left, 1 drawer, 1 extension</i>	117,0	47,8	48,0	GWPWSA11L		1730
	Waschtisch-Unterschrank <b>mit Siphon-Ausschnitt rechts</b> , 1 Schubkasten, 1 Auszug <i>washbasin base cabinet with siphon-cutout right, 1 drawer, 1 extension</i>	117,0	47,8	48,0	GWPWSA11R		1730
	Waschtisch-Unterschrank <b>mit Siphon-Ausschnitt mittig</b> , 1 Schubkasten, 1 Auszug <i>washbasin base cabinet with siphon-cutout center, 1 drawer, 1 extension</i>	117,0	47,8	48,0	GWPWSA11M		1730
	Waschtisch-Unterschrank <b>mit Siphon-Ausschnitt links</b> , 2 Schubkästen, 1 Auszug <i>washbasin base cabinet with siphon-cutout left, 2 drawers, 1 extension</i>	117,0	60,6	48,0	GWPWSSA11L		2053
	Waschtisch-Unterschrank <b>mit Siphon-Ausschnitt rechts</b> , 2 Schubkästen, 1 Auszug <i>washbasin base cabinet with siphon-cutout right, 2 drawers, 1 extension</i>	117,0	60,6	48,0	GWPWSSA11R		2053
	Waschtisch-Unterschrank <b>mit Siphon-Ausschnitt mittig</b> , 2 Schubkästen, 1 Auszug <i>washbasin base cabinet with siphon-cutout center, 2 drawers, 1 extension</i>	117,0	60,6	48,0	GWPWSSA11M		2053

# 3390line »Erweiterung der Waschtischlösungen/Extension of the washbasin solutions«

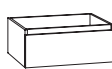
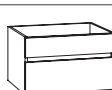
Beschreibung Description	Maße in cm Dimensions in cm			Artikel-Nr. Article no.	Türanschlag Door stop	Identnummer ID number
	B/W	H	T/D			

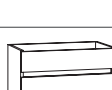
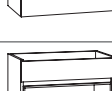
## Ohne Abdeckplatte / without top









						PG1
	Unterschrank 1 Auszug  <i>base cabinet 1 extension</i>	40,0	23,8	48,0	<b>GUWA4</b>	<b>739</b>
	Unterschrank 1 Schubkasten, 1 Auszug  <i>base cabinet 1 drawer, 1 extension</i>	40,0	36,6	48,0	<b>GUWSA4</b>	<b>992</b>
	Unterschrank 2 Auszüge  <i>base cabinet 2 extensions</i>	40,0	47,8	48,0	<b>GUWAA4</b>	<b>1038</b>
	Unterschrank 1 Schubkasten, 2 Auszüge  <i>base cabinet 1 drawer, 2 extensions</i>	40,0	60,6	48,0	<b>GUWSAA4</b>	<b>1362</b>
	 Unterschrank 1 Schubkasten, 1 Einschubregal, 1 Auszug  <i>base cabinet 1 drawer, 1 push-in shelf, 1 extension</i>	40,0	60,6	48,0	<b>GUWSEA4</b>	<b>1246</b>
	Unterschrank 1 Auszug  <i>base cabinet 1 extension</i>	60,0	23,8	48,0	<b>GUWA6</b>	<b>785</b>
	Unterschrank 1 Schubkasten, 1 Auszug  <i>base cabinet 1 drawer, 1 extension</i>	60,0	36,6	48,0	<b>GUWSA6</b>	<b>1154</b>
	Unterschrank 2 Auszüge  <i>base cabinet 2 extensions</i>	60,0	47,8	48,0	<b>GUWAA6</b>	<b>1200</b>
	Unterschrank 1 Schubkasten, 2 Auszüge  <i>base cabinet 1 drawer, 2 extensions</i>	60,0	60,6	48,0	<b>GUWSAA6</b>	<b>1476</b>
	 Unterschrank 1 Schubkasten, 1 Einschubregal, 1 Auszug  <i>base cabinet 1 drawer, 1 push-in shelf, 1 extension</i>	60,0	60,6	48,0	<b>GUWSEA6</b>	<b>1407</b>

 Regalfarben unbedingt mit angeben, Übersicht siehe Seite 4. Please indicate shelf colours, overview see page 4

# 3390line »Erweiterung der Waschtischlösungen/Extension of the washbasin solutions«

Beschreibung Description	Maße in cm Dimensions in cm			Artikel-Nr. Article no.	Türanschlag Door stop	Identnummer ID number
	B/W	H	T/D			









## Ohne Abdeckplatte / without top

						PG1
	Unterschrank 1 Auszug  <i>base cabinet 1 extension</i>	97,0	23,8	48,0	<b>GUWA9</b>	<b>969</b>
	Unterschrank 1 Schubkasten, 1 Auszug  <i>base cabinet 1 drawer, 1 extension</i>	97,0	36,6	48,0	<b>GUWSA9</b>	<b>1407</b>
	Unterschrank 2 Auszüge  <i>base cabinet 2 extensions</i>	97,0	47,8	48,0	<b>GUWAA9</b>	<b>1453</b>
	Unterschrank 1 Schubkasten, 2 Auszüge  <i>base cabinet 1 drawer, 2 extensions</i>	97,0	60,6	48,0	<b>GUWSAA9</b>	<b>1822</b>
	Unterschrank 1 Auszug  <i>base cabinet 1 extension</i>	117,0	23,8	48,0	<b>GUWA11</b>	<b>1016</b>
	Unterschrank 1 Schubkasten, 1 Auszug  <i>base cabinet 1 drawer, 1 extension</i>	117,0	36,6	48,0	<b>GUWSA11</b>	<b>1546</b>
	Unterschrank 2 Auszüge  <i>base cabinet 2 extensions</i>	117,0	47,8	48,0	<b>GUWAA11</b>	<b>1591</b>
	Unterschrank 1 Schubkasten, 2 Auszüge  <i>base cabinet 1 drawer, 2 extensions</i>	117,0	60,6	48,0	<b>GUWSAA11</b>	<b>2030</b>

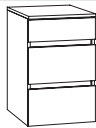
# 3390line »Erweiterung der Waschtischlösungen/Extension of the washbasin solutions«

Beschreibung Description	Maße in cm Dimensions in cm			Artikel-Nr. Article no.	Türanschlag Door stop	Identnummer ID number
	B/W	H	T/D			

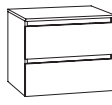
## Mit Abdeckplatte in Korpusfarbe / with top in carcass colour







						PG1
	Unterschrank 1 Auszug  <i>base cabinet 1 extension</i>	40,0	25,6	48,5	<b>GUWA4F</b>	<b>785</b>
	Unterschrank 1 Schubkasten, 1 Auszug  <i>base cabinet 1 drawer, 1 extension</i>	40,0	38,4	48,5	<b>GUWSA4F</b>	<b>1038</b>
	Unterschrank 2 Auszüge  <i>base cabinet 2 extensions</i>	40,0	49,6	48,5	<b>GUWAA4F</b>	<b>1085</b>
	Unterschrank 1 Schubkasten, 2 Auszüge  <i>base cabinet 1 drawer, 2 extensions</i>	40,0	62,4	48,5	<b>GUWSAA4F</b>	<b>1407</b>
	<b>i</b> Unterschrank 1 Schubkasten, 1 Einschubregal, 1 Auszug  <i>base cabinet 1 drawer, 1 push-in shelf, 1 extension</i>	40,0	62,4	48,5	<b>GUWSEA4F</b>	<b>1292</b>
	Unterschrank 1 Auszug  <i>base cabinet 1 extension</i>	60,0	25,6	48,5	<b>GUWA6F</b>	<b>830</b>
	Unterschrank 1 Schubkasten, 1 Auszug  <i>base cabinet 1 drawer, 1 extension</i>	60,0	38,4	48,5	<b>GUWSA6F</b>	<b>1200</b>
	Unterschrank 2 Auszüge  <i>base cabinet 2 extensions</i>	60,0	49,6	48,5	<b>GUWAA6F</b>	<b>1246</b>
	Unterschrank 1 Schubkasten, 2 Auszüge  <i>base cabinet 1 drawer, 2 extensions</i>	60,0	62,4	48,5	<b>GUWSAA6F</b>	<b>1522</b>
	<b>i</b> Unterschrank 1 Schubkasten, 1 Einschubregal, 1 Auszug  <i>base cabinet 1 drawer, 1 push-in shelf, 1 extension</i>	60,0	62,4	48,5	<b>GUWSEA6F</b>	<b>1453</b>

**i** Regalfarben unbedingt mit angeben, Übersicht siehe Seite 4. Please indicate shelf colours, overview see page 4

# 3390line »Erweiterung der Waschtischlösungen/Extension of the washbasin solutions«

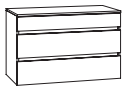





Beschreibung Description	Maße in cm Dimensions in cm			Artikel-Nr. Article no.	Türanschlag Door stop	Identnummer ID number
	B/W	H	T/D			

## Mit Abdeckplatte in Korpusfarbe / with top in carcass colour

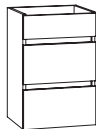
						PG1
	Unterschrank 1 Auszug  <i>base cabinet 1 extension</i>	97,0	25,6	48,5	<b>GUWA9F</b>	<b>1061</b>
	Unterschrank 1 Schubkasten, 1 Auszug  <i>base cabinet 1 drawer, 1 extension</i>	97,0	38,4	48,5	<b>GUWSA9F</b>	<b>1500</b>
	Unterschrank 2 Auszüge  <i>base cabinet 2 extensions</i>	97,0	49,6	48,5	<b>GUWAA9F</b>	<b>1546</b>
	Unterschrank 1 Schubkasten, 2 Auszüge  <i>base cabinet 1 drawer, 2 extensions</i>	97,0	62,4	48,5	<b>GUWSAA9F</b>	<b>1915</b>
	Unterschrank 1 Auszug  <i>base cabinet 1 extension</i>	117,0	25,6	48,5	<b>GUWA11F</b>	<b>1107</b>
	Unterschrank 1 Schubkasten, 1 Auszug  <i>base cabinet 1 drawer, 1 extension</i>	117,0	38,4	48,5	<b>GUWSA11F</b>	<b>1638</b>
	Unterschrank 2 Auszüge  <i>base cabinet 2 extensions</i>	117,0	49,6	48,5	<b>GUWAA11F</b>	<b>1684</b>
	Unterschrank 1 Schubkasten, 2 Auszüge  <i>base cabinet 1 drawer, 2 extensions</i>	117,0	62,4	48,5	<b>GUWSAA11F</b>	<b>2122</b>

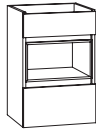
Beschreibung Description	Maße in cm Dimensions in cm			Artikel-Nr. Article no.	Türanschlag Door stop	Identnummer ID number
	B/W	H	T/D			











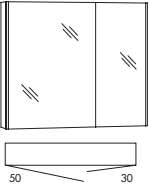

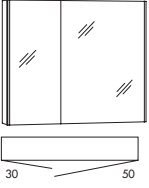

Ohne Abdeckplatte / without top

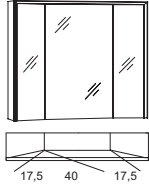
						PG1
	Unterschrank ohne Abdeckplatte 1 Schubkasten, 2 Auszüge  <i>base cabinet without top 1 drawer, 2 extensions</i>	40,0	60,6	35,0	<b>GUHSAA4</b>	<b>1246</b>
		40,0	60,6	35,0	<b>GUHSEA4</b>	<b>1154</b>
	Unterschrank ohne Abdeckplatte 1 Schubkasten, 2 Auszüge  <i>base cabinet without top 1 drawer, 2 extensions</i>	60,0	60,6	35,0	<b>GUHSAA6</b>	<b>1384</b>
		60,0	60,6	35,0	<b>GUHSEA6</b>	<b>1292</b>
	Sideboard ohne Abdeckplatte 1 Schubkasten, 2 Auszüge  <i>sideboard without top 1 drawer, 2 extensions</i>	97,0	60,6	35,0	<b>GUHSAA9</b>	<b>1661</b>
	Sideboard ohne Abdeckplatte 1 Schubkasten, 2 Auszüge  <i>sideboard without top 1 drawer, 2 extensions</i>	117,0	60,6	35,0	<b>GUHSAA11</b>	<b>1868</b>

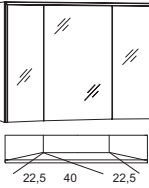
						PG1 Dickkante/thick edge
	Maßvariable Abdeckplatte für Unterschränke und Sideboards ohne Abdeckplatte  <i>cover panel in variable dimensions for base cabinets and sideboards without top</i>	200,0 max.	1,6	49,3 max.	<b>ADFV</b>	<b>221</b>

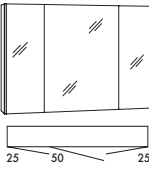







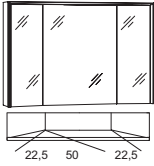

 Regalfarben unbedingt mit angeben, Übersicht siehe Seite 4. Please indicate shelf colours, overview see page 4

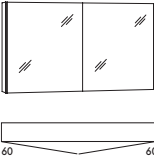
# 3390line »Spiegelschränke/mirror cabinets«

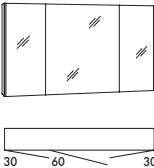
Beschreibung Description	Maße in cm Dimensions in cm			Artikel-Nr. Article no.	Türanschlag Door stop	Identnummer ID number
	B/W	H	T/D			
 <p>Spiegelschrank, 2 beidseitig verspiegelte Türen, 2 Glaseinlegeböden, inkl. Schalter/Steckdose, seitliche LED-Beleuchtung, 6000 K, 2x 6,3 W, 2x 660 Lumen, EEK F</p> <p><i>mirror cabinet, 2 doors mirrored on both sides, 2 glass boards, incl. switch/socket lateral LED-lighting, 6000 K, 2x 6,3 W, 2x 660 lumen, EEC F</i></p>	80,0	68,2	17,6	<b>SADA8L</b>		<b>1707</b>
Dieses Produkt enthält eine Lichtquelle der Energieeffizienzklasse F						
 <p>Spiegelschrank, 2 beidseitig verspiegelte Türen, 2 Glaseinlegeböden, inkl. Schalter/Steckdose, seitliche LED-Beleuchtung, 6000 K, 2x 6,3 W, 2x 660 Lumen, EEK F</p> <p><i>mirror cabinet, 2 doors mirrored on both sides, 2 glass boards, incl. switch/socket lateral LED-lighting, 6000 K, 2x 6,3 W, 2x 660 lumen, EEC F</i></p>	80,0	68,2	17,6	<b>SADA8R</b>		<b>1707</b>
Dieses Produkt enthält eine Lichtquelle der Energieeffizienzklasse F						
 <p>LED-Aufbauleuchte für Spiegelschrank mit LED-Mini-Stecker, 6000 K, 10,8 W, 1350 Lumen, EEK E</p> <p><i>LED-lighting for mirror cabinet with LED-mini-plug, 6000 K, 10,8 W, 1350 lumen, EEC E</i></p>	80,0	2,4	20,0	<b>AW80</b>		<b>415</b>
Dieses Produkt enthält eine Lichtquelle der Energieeffizienzklasse E						
 <p>Spiegelschrank, 3 Spiegeltüren - davon 2 trapezförmig angeordnet, 6 Glaseinlegeböden, inkl. Schalter/Steckdose, <b>seitlich und oben LED-Beleuchtung</b>, 6000 K, 17,2 W, 960 Lumen, EEK E</p> <p><i>mirror cabinet, 3 mirror doors - 2 of them are arranged in a trapeze, 6 glass shelves, incl. switch/socket, lateral and top LED lighting, 6000 K, 17,2 W, 960 lumen, EEC E</i></p>	80,0	68,2	17,6	<b>SDU8</b>		<b>2238</b>
Dieses Produkt enthält eine Lichtquelle der Energieeffizienzklasse E						
 <p>Spiegelschrank, 3 Spiegeltüren - davon 2 trapezförmig angeordnet, 6 Glaseinlegeböden, inkl. Schalter/Steckdose, <b>seitlich und oben LED-Beleuchtung</b>, 6000 K, 17,9 W, 960 Lumen, EEK E</p> <p><i>mirror cabinet, 3 mirror doors - 2 of them are arranged in a trapeze, 6 glass shelves, incl. switch/socket, lateral and top LED lighting, 6000 K, 17,9 W, 960 lumen, EEC E</i></p>	90,0	68,2	17,6	<b>SDU9</b>		<b>2307</b>
Dieses Produkt enthält eine Lichtquelle der Energieeffizienzklasse E						
 <p>Spiegelschrank, 3 beidseitig verspiegelte Türen, 4 Glaseinlegeböden, inkl. Schalter/Steckdose, seitliche LED-Beleuchtung, 6000 K, 2x 6,3 W, 2x 660 Lumen, EEK F</p> <p><i>mirror cabinet, 3 doors mirrored on both sides, 4 glass boards, incl. switch/socket lateral LED-lighting, 6000 K, 2x 6,3 W, 2x 660 lumen, EEC F</i></p>	100,0	68,2	17,6	<b>SADA10</b>		<b>2076</b>
Dieses Produkt enthält eine Lichtquelle der Energieeffizienzklasse F						
 <p>LED-Aufbauleuchte für Spiegelschrank mit LED-Mini-Stecker, 6000 K, 13,8 W, 1728 Lumen, EEK E</p> <p><i>LED-lighting for mirror cabinet with LED-mini-plug, 6000 K, 13,8 W, 1728 lumen, EEC E</i></p>	100,0	2,4	20,0	<b>AW100</b>		<b>461</b>
Dieses Produkt enthält eine Lichtquelle der Energieeffizienzklasse E						

EEK/EEC=Energieeffizienzklasse/energy efficiency category  
Leuchtmittel sind nicht austauschbar / illuminants are not interchangeable.

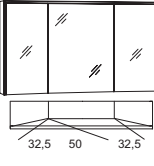
# 3390line »Spiegelschränke/ mirror cabinets«











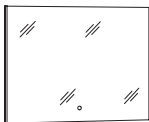





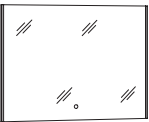

Beschreibung Description	Maße in cm Dimensions in cm			Artikel-Nr. Article no.	Türanschlag Door stop	Identnummer ID number
	B/W	H	T/D			
 <p>Spiegelschrank, 3 Spiegeltüren - davon 2 trapezförmig angeordnet, 6 Glaseinlegeböden, inkl. Schalter/Steckdose, <b>seitlich und oben LED-Beleuchtung</b>, 6000 K, 18,7 W, 960 Lumen, EEK E</p> <p><i>mirror cabinet, 3 mirror doors - 2 of them are arranged in a trapeze, 6 glass shelves, incl. switch/socket, <b>lateral and top LED lighting</b>, 6000 K, 18,7 W, 960 lumen, EEC E</i></p>	100,0	68,2	17,6	<b>SDU10</b>		<b>2376</b>
Dieses Produkt enthält eine Lichtquelle der Energieeffizienzklasse E						
 <p>Spiegelschrank, 2 beidseitig verspiegelte Türen, 4 Glaseinlegeböden, inkl. Schalter/Steckdose, seitliche LED-Beleuchtung, 6000 K, 2x 6,3 W, 2x 660 Lumen, EEK F</p> <p><i>mirror cabinet, 2 doors mirrored on both sides, 4 glass boards, incl. switch/socket lateral LED-lighting, 6000 K, 2x 6,3 W, 2x 660 lumen, EEC F</i></p>	120,0	68,2	17,6	<b>SADA12D</b>		<b>1961</b>
Dieses Produkt enthält eine Lichtquelle der Energieeffizienzklasse F						
 <p>Spiegelschrank, 3 beidseitig verspiegelte Türen, 6 Glaseinlegeböden, inkl. Schalter/Steckdose, seitliche LED-Beleuchtung, 6000 K, 2x 6,3 W, 2x 660 Lumen, EEK F</p> <p><i>mirror cabinet, 3 doors mirrored on both sides, 6 glass boards, incl. switch/socket lateral LED-lighting, 6000 K, 2x 6,3 W, 2x 660 lumen, EEC F</i></p>	120,0	68,2	17,6	<b>SADA12</b>		<b>2168</b>
Dieses Produkt enthält eine Lichtquelle der Energieeffizienzklasse F						
 <p>LED-Aufbauleuchte für Spiegelschrank mit LED-Mini-Stecker, 6000 K, 16,8 W, 2106 Lumen, EEK E</p> <p><i>LED-lighting for mirror cabinet with LED-mini-plug, 6000 K, 16,8 W, 2106 lumen, EEC E</i></p>	120,0	2,4	20,0	<b>AW120</b>		<b>485</b>
Dieses Produkt enthält eine Lichtquelle der Energieeffizienzklasse E						
 <p>Spiegelschrank, 3 Spiegeltüren - davon 2 trapezförmig angeordnet, 6 Glaseinlegeböden, inkl. Schalter/Steckdose, <b>seitlich und oben LED-Beleuchtung</b>, 6000 K, 20,3 W, 960 Lumen, EEK E</p> <p><i>mirror cabinet, 3 mirror doors - 2 of them are arranged in a trapeze, 6 glass shelves, incl. switch/socket, <b>lateral and top LED lighting</b>, 6000 K, 20,3 W, 960 lumen, EEC E</i></p>	120,0	68,2	17,6	<b>SDU12</b>		<b>2492</b>
Dieses Produkt enthält eine Lichtquelle der Energieeffizienzklasse E						

EEK/EEC=Energieeffizienzklasse/energy efficiency category

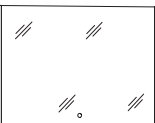
Leuchtmittel sind nicht austauschbar / illuminants are not interchangeable.









# 3390line »Spiegelpaneele/mirror panels«

Beschreibung Description	Maße in cm Dimensions in cm			Artikel-Nr. Article no.	Türanschlag Door stop	Identnummer ID number
	B/W	H	T/D			
 <p>Spiegelpaneel, Sensorschalter, seitliche LED-Beleuchtung 6000 K, 2x 6,3 W, 2x 660 Lumen, EEK F <b>Helligkeit dimmbar</b></p> <p><i>mirror panel, sensor switch, lateral LED-lighting 6000 K, 2x 6,3 W, 2x 660 lumen, EEC F</i> <b>brighness dimmable</b></p>	80,0	68,2	2,8	<b>SPBSA8</b>	  <p>Dieses Produkt enthält eine Lichtquelle der Energieeffizienzklasse F</p>	1154
 <p>LED-Aufbauleuchte für Spiegelpaneel mit LED-Mini-Stecker, 6000 K, 10,8 W, 1350 Lumen, EEK E <b>Helligkeit dimmbar</b></p> <p><i>LED-lighting for mirror panel with LED-mini-plug, 6000 K, 10,8 W, 1350 lumen, EEC E</i> <b>brighness dimmable</b></p>	80,0	2,4	10,0	<b>AWP80</b>	  <p>Dieses Produkt enthält eine Lichtquelle der Energieeffizienzklasse E</p>	370
 <p>Spiegelpaneel, Sensorschalter, seitliche LED-Beleuchtung 6000 K, 2x 6,3 W, 2x 660 Lumen, EEK F <b>Helligkeit dimmbar</b></p> <p><i>mirror panel, sensor switch, lateral LED-lighting 6000 K, 2x 6,3 W, 2x 660 lumen, EEC F</i> <b>brighness dimmable</b></p>	90,0	68,2	2,8	<b>SPBSA9</b>	  <p>Dieses Produkt enthält eine Lichtquelle der Energieeffizienzklasse F</p>	1200
 <p>LED-Aufbauleuchte für Spiegelpaneel mit LED-Mini-Stecker, 6000 K, 12,5 W, 1566 Lumen, EEK E <b>Helligkeit dimmbar</b></p> <p><i>LED-lighting for mirror panel with LED-mini-plug, 6000 K, 12,5 W, 1566 lumen, EEC E</i> <b>brighness dimmable</b></p>	90,0	2,4	10,0	<b>AWP90</b>	  <p>Dieses Produkt enthält eine Lichtquelle der Energieeffizienzklasse E</p>	392
 <p>Spiegelpaneel, Sensorschalter, seitliche LED-Beleuchtung 6000 K, 2x 6,3 W, 2x 660 Lumen, EEK F <b>Helligkeit dimmbar</b></p> <p><i>mirror panel, sensor switch, lateral LED-lighting 6000 K, 2x 6,3 W, 2x 660 lumen, EEC F</i> <b>brighness dimmable</b></p>	100,0	68,2	2,8	<b>SPBSA10</b>	  <p>Dieses Produkt enthält eine Lichtquelle der Energieeffizienzklasse F</p>	1246
 <p>LED-Aufbauleuchte für Spiegelpaneel mit LED-Mini-Stecker, 6000 K, 13,7 W, 1440 Lumen, EEK F <b>Helligkeit dimmbar</b></p> <p><i>LED-lighting for mirror panel with LED-mini-plug, 6000 K, 13,7 W, 1440 lumen, EEC F</i> <b>brighness dimmable</b></p>	100,0	2,4	10,0	<b>AWP100</b>	  <p>Dieses Produkt enthält eine Lichtquelle der Energieeffizienzklasse F</p>	415

EEK/EEC=Energieeffizienzklasse/energy efficiency category



Leuchtmittel sind nicht austauschbar / illuminants are not interchangeable.



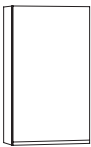
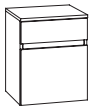
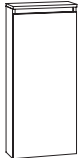
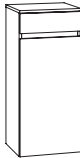

# 3390line »Spiegelpaneele/mirror panels«

Beschreibung Description	Maße in cm Dimensions in cm			Artikel-Nr. Article no.	Türanschlag Door stop	Identnummer ID number
	B/W	H	T/D			
 <p>Spiegelpaneel, Sensorschalter, seitliche LED-Beleuchtung 6000 K, 2x 6,3 W, 2x 660 Lumen, EEK F <b>Helligkeit dimmbar</b></p> <p><i>mirror panel, sensor switch, lateral LED-lighting 6000 K, 2x 6,3 W, 2x 660 lumen, EEC F</i> <b>brighness dimmable</b></p>	120,0	68,2	2,8	<b>SPBSA12</b>	  <p>Dieses Produkt enthält eine Lichtquelle der Energieeffizienzklasse F</p>	<b>1292</b>
 <p>LED-Aufbauleuchte für Spiegelpaneel mit LED-Mini-Stecker, 6000 K, 17,3 W, 2160 Lumen, EEK E <b>Helligkeit dimmbar</b></p> <p><i>LED-lighting for mirror panel with LED-mini-plug, 6000 K, 17,3 W, 2160 lumen, EEC E</i> <b>brighness dimmable</b></p>	120,0	2,4	10,0	<b>AWP120</b>	  <p>Dieses Produkt enthält eine Lichtquelle der Energieeffizienzklasse E</p>	<b>439</b>

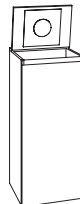
EEK/EEC=Energieeffizienzklasse/energy efficiency category  
Leuchtmittel sind nicht austauschbar / illuminants are not interchangeable.

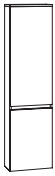
# 3390line »Beistellschränke/ side cabinets«



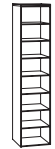



Beschreibung Description	Maße in cm Dimensions in cm			Artikel-Nr. Article no.	Türanschlag Door stop	Identnummer ID number
	B/W	H	T/D			
 <p>Oberschrank 1 Tür 2 Glaseinlegeböden</p> <p><i>top cabinet 1 door 2 glass boards</i></p>	40,0	68,2	17,6	<b>GOT40DL</b> <b>GOT40DR</b>	Links/ <i>left</i> Rechts/ <i>right</i>	PG1 <b>485</b>
 <p>Unterschrank inkl. Abdeckplatte 1 Tür, 1 Schubkasten</p> <p><i>base cabinet incl. top 1 door, 1 drawer</i></p>	40,0	49,6	35,0	<b>GUST4FL</b> <b>GUST4FR</b>	Links/ <i>left</i> Rechts/ <i>right</i>	<b>830</b>
 <p>Highboard inkl. Abdeckplatte 1 Tür 2 Glaseinlegeböden</p> <p><i>high cabinet incl. top 1 door 2 glass boards</i></p>	40,0	91,2	17,6	<b>GHBFT4FL</b> <b>GHBFT4FR</b>	Links/ <i>left</i> Rechts/ <i>right</i>	<b>692</b>
 <p>Highboard inkl. Abdeckplatte 1 Tür, 1 Schubkasten 2 Glaseinlegeböden</p> <p><i>high cabinet incl. top 1 door, 1 drawer 2 glass boards</i></p>	40,0	91,2	35,0	<b>GHBST4FL</b> <b>GHBST4FR</b>	Links/ <i>left</i> Rechts/ <i>right</i>	<b>739</b> <b>992</b>
 <p>Highboard inkl. Abdeckplatte 1 Tür/Wäschekippe</p> <p><i>high cabinet incl. top 1 door/linen bin</i></p>	40,0	91,2	35,0	<b>GHBW4F</b>		<b>785</b>
 <p>Schminkschrank inkl. Deckel 1 Tür, 1 Klappe 2 Glaseinlegeböden Kosmetikeinsatz &amp; Vergrößerungsspiegel</p> <p><i>make-up cabinet incl. lid 1 door, 1 flap door 2 glass boards cosmetic insert part &amp; magnifying mirror</i></p>	40,0	91,2	35,0	<b>GHBKT4L</b> <b>GHBKT4R</b>	Links/ <i>left</i> Rechts/ <i>right</i>	<b>1384</b>

Beschreibung Description	Maße in cm Dimensions in cm			Artikel-Nr. Article no.	Türanschlag Door stop	Identnummer ID number
	B/W	H	T/D			
PG1						
 <p>Mittelschrank inkl. Abdeckplatte 2 Türen 3 Glaseinlegeböden</p> <p><i>medium cabinet incl. top 2 doors 3 glass boards</i></p>	40,0	148,8	35,0	<b>GMTT4FL</b> <b>GMTT4FR</b>	Links/left Rechts/right	<b>1107</b>
 <p>Mittelschrank inkl. Abdeckplatte 2 Türen, 1 Einschubregal 2 Glaseinlegeböden</p> <p><i>medium cabinet incl. top 2 doors, 1 push-in shelf 2 glass boards</i></p>	40,0	148,8	35,0	<b>GMTET4FL</b> <b>GMTET4FR</b>	Links/left Rechts/right	<b>1338</b>
 <p>Mittelschrank inkl. Abdeckplatte 2 Türen, 1 Schubkasten 3 Glaseinlegeböden</p> <p><i>medium cabinet incl. top 2 doors, 1 drawer 3 glass boards</i></p>	40,0	148,8	35,0	<b>GMTST4FL</b> <b>GMTST4FR</b>	Links/left Rechts/right	<b>1362</b>
 <p>Mittelschrank inkl. Abdeckplatte 1 Tür, 2 Auszüge 2 Glaseinlegeböden</p> <p><i>medium cabinet incl. top 1 door, 2 extensions 2 glass boards</i></p>	40,0	148,8	35,0	<b>GMTAA4FL</b> <b>GMTAA4FR</b>	Links/left Rechts/right	<b>1546</b>
 <p>Glasregal mit Holzrückwand in Korpus- farbe, inkl. Abdeckplatte 7 Glasböden</p> <p><i>glass shelf with wooden back panel in carcase colour, incl. top 7 glass boards</i></p>	33,8	148,8	15,0	<b>MGR33F</b>		<b>2583</b>  <b>Bitte Korpusfarbe angeben</b> <b>Please indicate shelf colour</b>

**i** Regalfarben unbedingt mit angeben, Übersicht siehe Seite 4. *Please indicate shelf colours, overview see page 4*







# 3390line »Beistellschränke/ side cabinets«

Beschreibung Description	Maße in cm Dimensions in cm			Artikel-Nr. Article no.	Türanschlag Door stop	Identnummer ID number
	B/W	H	T/D			

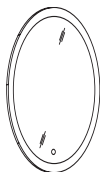
						PG1	
	Hochschrank 2 Türen 4 Glaseinlegeböden	40,0	178,7	17,6	<b>GHFTT4L</b> <b>GHFTT4R</b>	Links/ <i>left</i> Rechts/ <i>right</i>	<b>1061</b>
	<i>tower cabinet</i> <i>2 doors</i> <i>4 glass boards</i>	40,0	178,7	35,0	<b>GHTT4L</b> <b>GHTT4R</b>	Links/ <i>left</i> Rechts/ <i>right</i>	<b>1246</b>
 	Hochschrank 2 Türen, 1 Einschubregal 4 Glaseinlegeböden	40,0	178,7	35,0	<b>GHTET4L</b> <b>GHTET4R</b>	Links/ <i>left</i> Rechts/ <i>right</i>	<b>1522</b>
<i>tower cabinet</i> <i>2 doors, 1 push-in shelf</i> <i>4 glass boards</i>							
	Hochschrank 2 Türen, 1 Schubkasten 3 Glaseinlegeböden	40,0	178,7	35,0	<b>GHTST4L</b> <b>GHTST4R</b>	Links/ <i>left</i> Rechts/ <i>right</i>	<b>1546</b>
<i>tower cabinet</i> <i>2 doors, 1 drawer</i> <i>3 glass boards</i>							
	Hochschrank 1 Tür, 1 Tür/Wäschekippe 2 Glaseinlegeböden	40,0	178,7	35,0	<b>GHTW4L</b> <b>GHTW4R</b>	Links/ <i>left</i> Rechts/ <i>right</i>	<b>1292</b>
<i>tower cabinet</i> <i>1 door, 1 door/linen bin</i> <i>2 glass boards</i>							
	Hochschrank 1 Tür, 3 Auszüge 2 Glaseinlegeböden	40,0	178,7	35,0	<b>GHTAAA4L</b> <b>GHTAAA4R</b>	Links/ <i>left</i> Rechts/ <i>right</i>	<b>1915</b>
<i>tower cabinet</i> <i>1 door, 3 extensions</i> <i>2 glass boards</i>							
	Glasregal mit Holzrückwand in Korpusfarbe 7 Glasböden	33,8	178,7	15,0	<b>HGR33</b>		<b>2953</b>
<i>glass shelf with wooden back panel in carcass colour</i> <i>7 glass boards</i>						<b>Bitte Korpusfarbe angeben</b> <b>Please indicate shelf colour</b>	

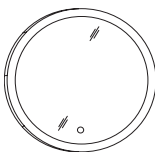
 Regalfarben unbedingt mit angeben, Übersicht siehe Seite 4. Please indicate shelf colours, overview see page 4

# 3390line »Spiegelpaneele und Zubehör/mirror panels and accessoires«

Beschreibung Description	Maße in cm Dimensions in cm			Artikel-Nr. Article no.	Türanschlag Door stop	Identnummer ID number
	B/W	H	T/D			
 <p>Spiegelpaneel, Sensorschalter, satiniert, LED Beleuchtung, 4000 K, 17,3 W, 2415 Lumen, EEK G <b>Helligkeit dimmbar</b></p> <p><i>mirror panel, sensor switch, satined, LED-lighting, 4000 K, 17,3 W, 2415 lumen, EEC G <b>brighness dimmable</b></i></p>	55,0	78,0	2,8	<b>SPE55</b>	  Dieses Produkt enthält eine Lichtquelle der Energieeffizienzklasse G	1131
 <p>Spiegelpaneel, Sensorschalter, satiniert, LED Beleuchtung, 4000 K, 13,5 W, 1890 Lumen, EEK G <b>Helligkeit dimmbar</b></p> <p><i>mirror panel, sensor switch, satined, LED-lighting, 4000 K, 13,5 W, 1890 lumen, EEC G <b>brighness dimmable</b></i></p>	55,0	55,0	2,8	<b>SPK55</b>	  Dieses Produkt enthält eine Lichtquelle der Energieeffizienzklasse G	992
 <p>Spiegelpaneel, Sensorschalter, satiniert, LED Beleuchtung, 4000 K, 20,8 W, 2905 Lumen, EEK G <b>Helligkeit dimmbar</b></p> <p><i>mirror panel, sensor switch, satined, LED-lighting, 4000 K, 20,8 W, 2905 lumen, EEC G <b>brighness dimmable</b></i></p>	78,0	78,0	2,8	<b>SPK78</b>	  Dieses Produkt enthält eine Lichtquelle der Energieeffizienzklasse G	1292
 <p>Waschtischkonsole mit Handtuchhalter, verchromt</p> <p><i>washbasin console with towel rail, chrome-plated</i></p>	4,0	15,0	45,0	<b>HK45</b>		397
 <p>Waschtischkonsole Stahlrohr 4 x 4 cm</p> <p><i>washbasin mounting bracket steel 4 x 4 cm</i></p>	4,0	4,0	39,2	<b>WK</b>		148
 <p>Steckdose/Powerbox für Spiegelschränke Ausführung <b>Schweiz</b> IP44 mit USB-C Stecker</p> <p><i>Power socket for mirror cabinets <b>Switzerland</b> type IP44 with USB-C plug</i></p>					<b>Mehrpreis extra charge</b>	138
 <p>Steckdose/Powerbox für Spiegelschränke Ausführung <b>Frankreich</b> mit USB-C Stecker</p> <p><i>Power socket for mirror cabinets <b>France</b> type with USB-C plug</i></p>					<b>Mehrpreis extra charge</b>	138

EEK/EEC=Energieeffizienzklasse/energy efficiency category  
Leuchtmittel sind nicht austauschbar / illuminants are not interchangeable.

**i** Weiteres Zubehör finden Sie im Register 3970.  
**Further accessoires can be found in register 3970.**

# 3390line »Maße/dimensions«

Bohrlochhöhen für Schraubhaken, Anschlussmaße und Abflusshöhen/drilling point for screw hooks, dimensions for mounting and drain

Bei Montage ohne Unterschrank sind 2 Konsolen (WK oder HK45) erforderlich. Bei Montage mit einem Unterschrank, nur auf einer Seite, ist eine Konsole (WK oder HK45) auf der gegenüberliegenden Seite erforderlich.

2 brackets (WK or HK45) are required for installation without base unit. When mounting with a base cabinet on one side only a console (WK or HK45) is required on the opposite side.

INGA/WTFI8M  
WTFI8M

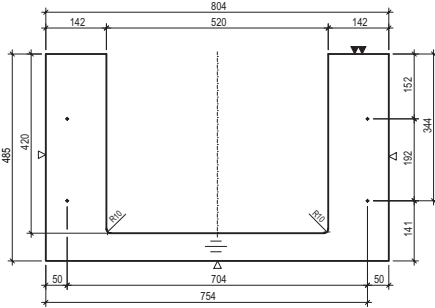

INGA/WTFI12L  
WTFI12L

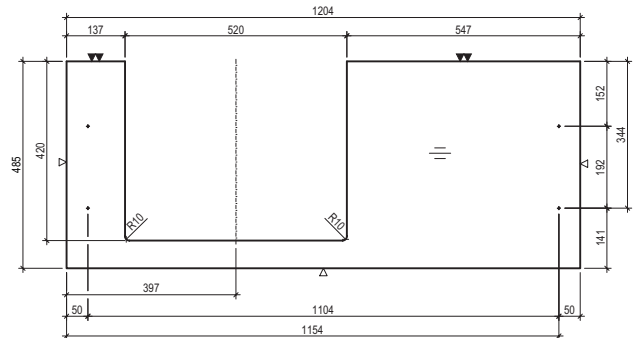

INGA/WTFI12M  
WTFI12M

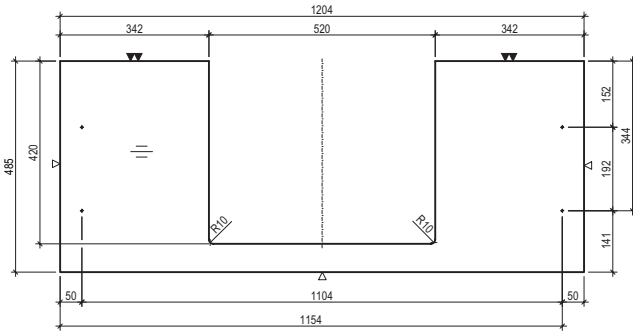

INGA/WTFI12R  
WTFI12R

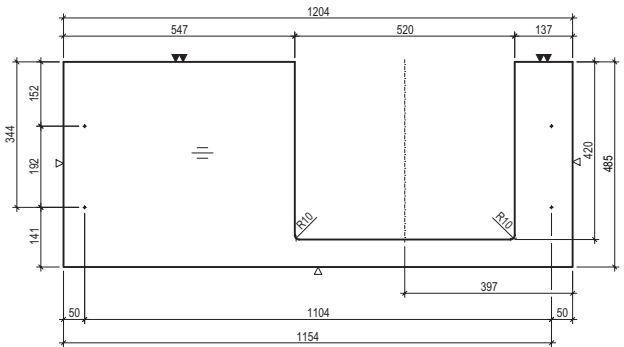

BELLA/WTFB8M  
WTPB8M

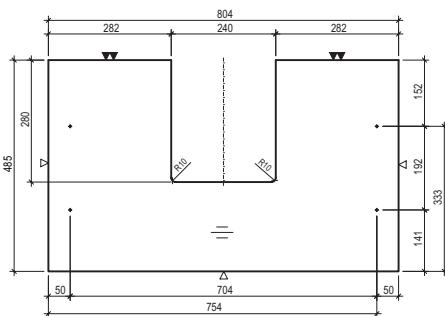

BELLA/WTFB12L  
WTPB12L

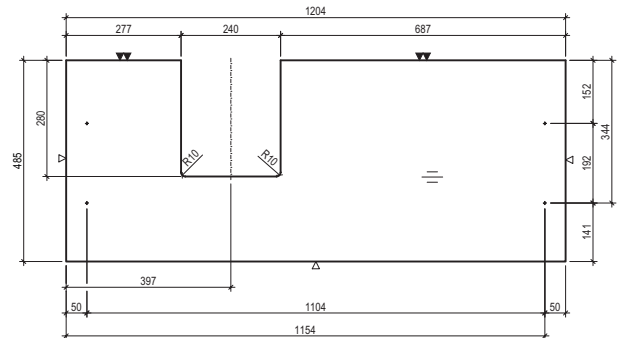

BELLA/WTFB12M  
WTPB12M

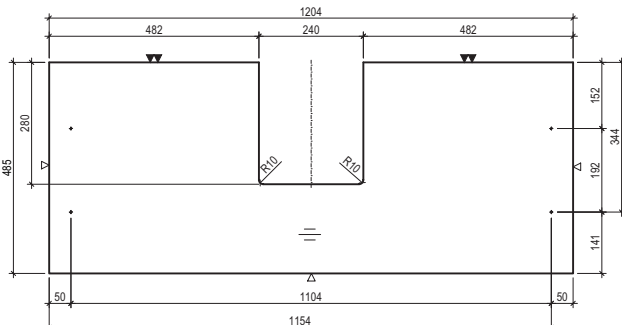

BELLA/WTFB12R  
WTPB12R

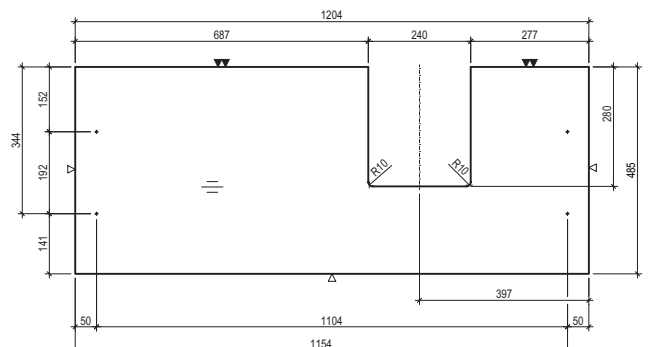

**!** Achtung: Die Montage muss durch fachkundige Personen erfolgen. Der Untergrund zur Wandbefestigung ist vor Montage zu prüfen. Bitte wählen Sie entsprechend das geeignete Befestigungsmaterial. Fehlerhafte Montagen können das Möbel beschädigen oder dessen Funktion dauerhaft beeinträchtigen. Für Sach- und Personenschäden übernehmen wir im Falle einer unsachgemäßen Montage keine Haftung.  
Attention: Assembly must be carried out by skilled personnel. The subsurface for the wall mounting must be checked before assembly. Please select a suitable mounting material. Faulty assembly can damage furniture or permanently impair its function. We will not be held responsible for damage to material or persons in the case of improper assembly.

# 3390line »Maße/dimensions«

Bohrlochhöhen für Schraubhaken, Anschlussmaße und Abflusshöhen/drilling point for screw hooks, dimensions for mounting and drain

Bei Montage ohne Unterschrank sind 2 Konsolen (WK oder HK45) erforderlich.  
Bei Montage mit einem Unterschrank, nur auf einer Seite, ist eine Konsole (WK oder HK45) auf der gegenüberliegenden Seite erforderlich.

2 brackets (WK or HK45) are required for installation without base unit. When mounting with a base cabinet on one side only a console (WK or HK45) is required on the opposite side.



POCO/WTFP8M  
WTFP8M

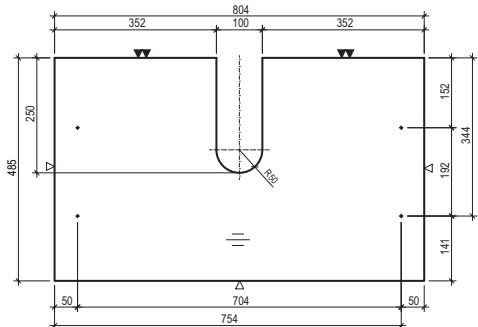

POCO/WTFP12L  
WTFP12L

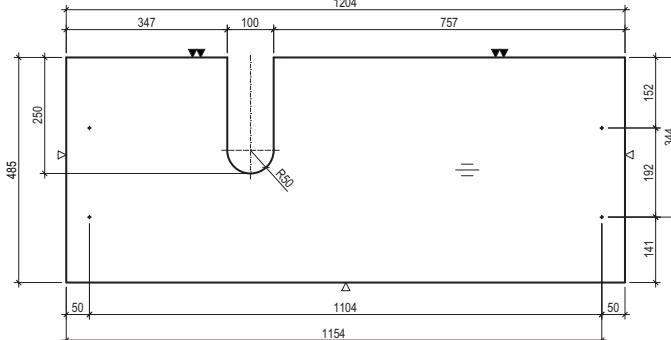

POCO/WTFP12M  
WTFP12M

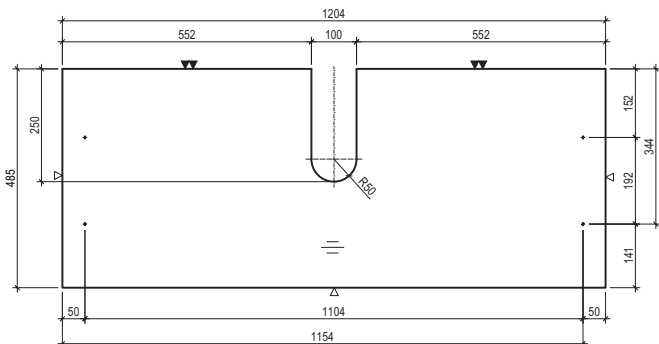

POCO/WTFP12R  
WTFP12R

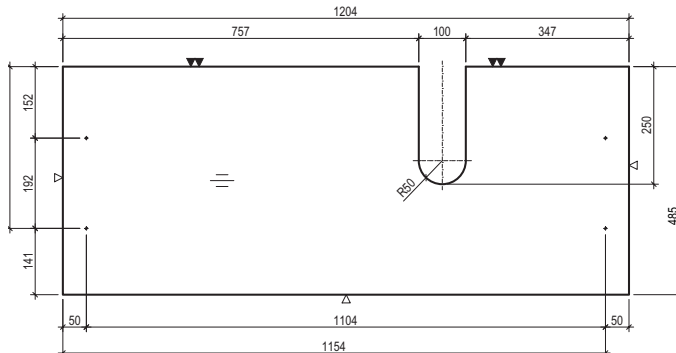

RUMBA/WTFA8M  
WTPA8M

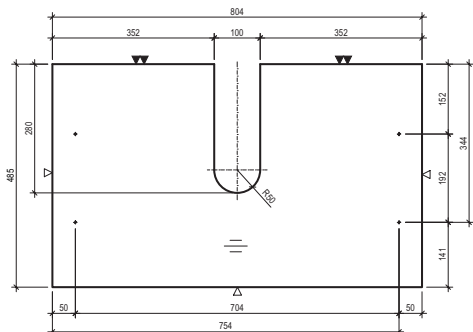

RUMBA/WTFA12L  
WTPA12L

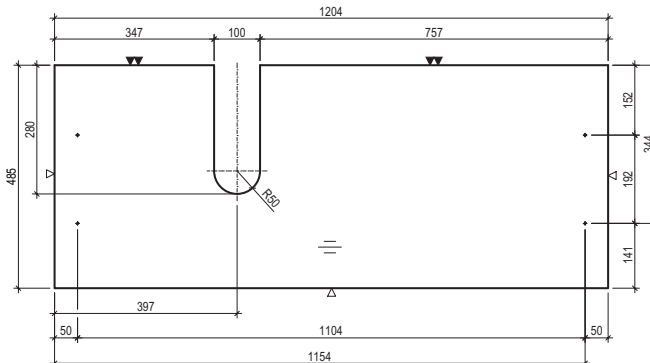

RUMBA/WTFA12M  
WTPA12M

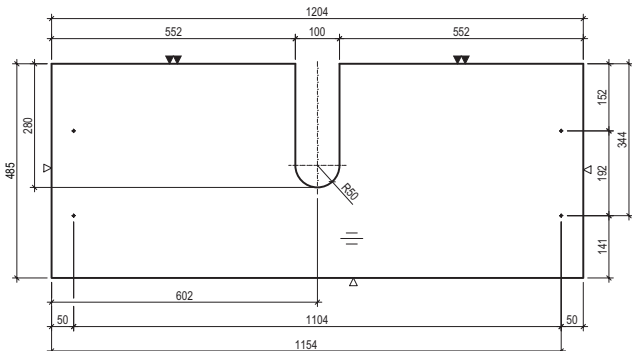

RUMBA/WTFA12R  
WTPA12R

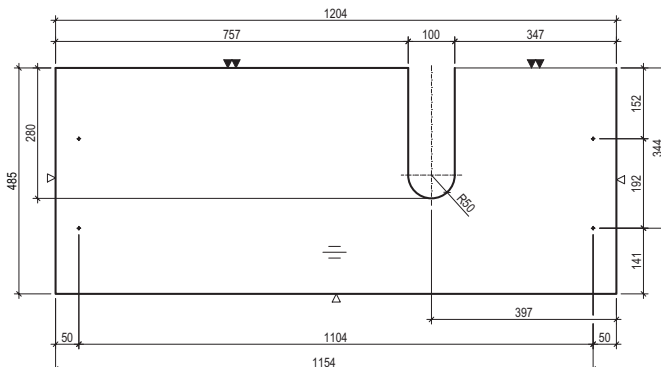

**!** Achtung: Die Montage muss durch fachkundige Personen erfolgen. Der Untergrund zur Wandbefestigung ist vor Montage zu prüfen. Bitte wählen Sie entsprechend das geeignete Befestigungsmaterial. Fehlerhafte Montagen können das Möbel beschädigen oder dessen Funktion dauerhaft beeinträchtigen. Für Sach- und Personenschäden übernehmen wir im Falle einer unsachgemäßen Montage keine Haftung.

Attention: Assembly must be carried out by skilled personnel. The subsurface for the wall mounting must be checked before assembly. Please select a suitable mounting material. Faulty assembly can damage furniture or permanently impair its function. We will not be held responsible for damage to material or persons in the case of improper assembly.





# 3460marlinplan





# »3460marlinplan«

## Piktogramme/pictograms



Mineralmarmor Waschtisch  
Marble minerals washbasin

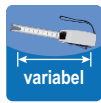

Waschtisch maßvariabel  
washbasin with variable size



LED Lichtfarbe regelbar,  
Helligkeit dimmbar  
LED colour temperature adjust-  
able, brightness dimmable

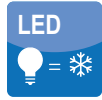

LED Lichtfarbe kalt  
LED colour temperature cold

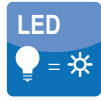

LED Lichtfarbe warm  
LED colour temperature warm



LED mit Sensorschalter,  
Helligkeit dimmbar  
LED with sensor switch,  
brightness dimmable

## Mineralmarmor Waschtisch weiß alpin Glanz (JS69) Marble minerals washbasin gloss alpine white (JS69)

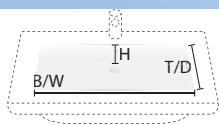

≈ Beckenmaße in cm (BxHxD)  
basin dimensions in cm (WxHxD)

alle Becken/all basins = 48,5 x 12 x 29 cm

alle Becken mit Clou-Ablaufsystem / all basin with Clou drainage system



Detail

Fixmaß  
fixed size

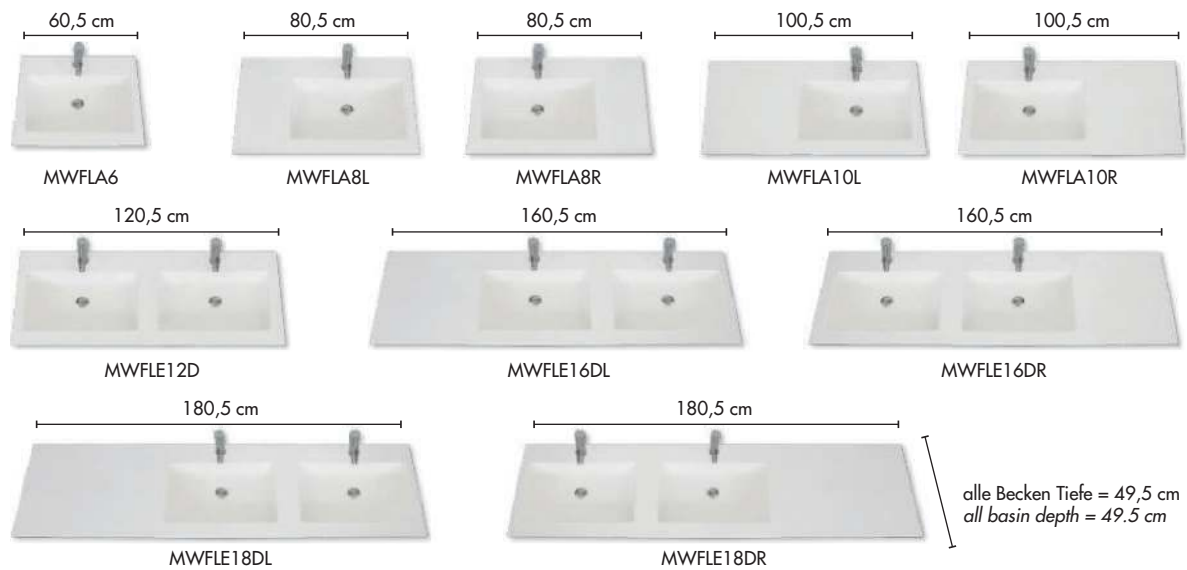

Variables Maß  
variable size

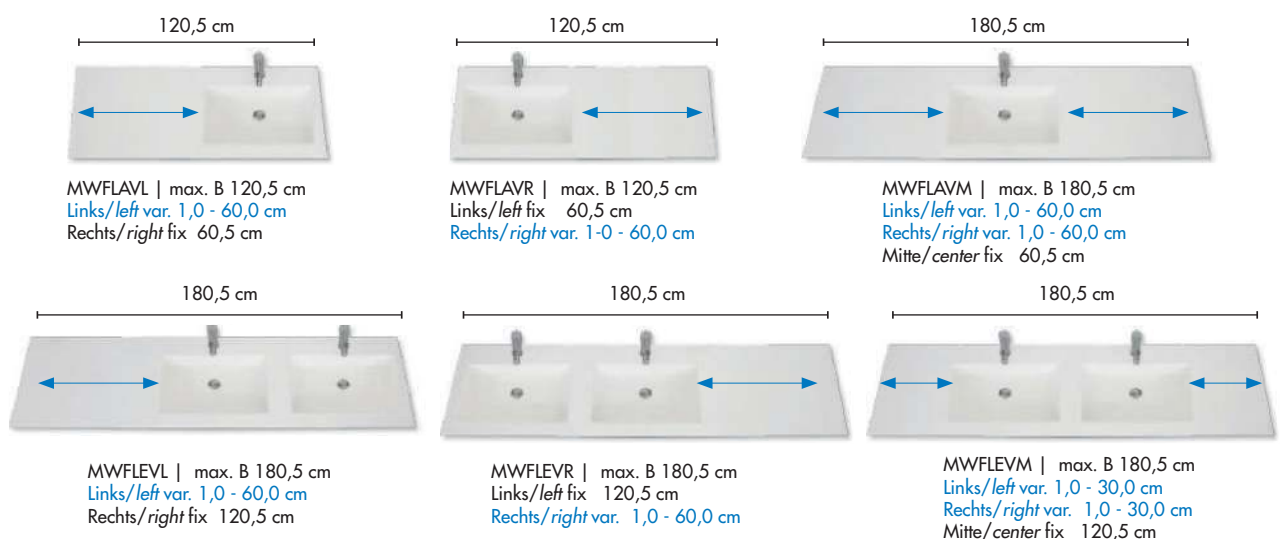

# »3460marlinplan« Farb-Varianten/colour options

## Schränke/cabinets 3460marlinplan

### Frontfarben/front colours

### Korpusfarben/basic shell colours

#### Dickkante/thick edge

#### PG 1 Dickkante/thick edge

286



**Weiß Seidenglanz**  
*Silk Gloss White*  
JSE\_

286



**Weiß Seidenglanz**  
*Silk Gloss White*  
E/JS86

284



**Anthrazit Seidenglanz**  
*Silk Gloss Anthracite*  
JSA\_

284



**Anthrazit Seidenglanz**  
*Silk Gloss Anthracite*  
A/JS84

490



**Kastanie Graphit Nachbildung**  
*Graphite Chestnut Finish*  
JSC\_

490



**Kastanie Graphit Nachbildung**  
*Graphite Chestnut Finish*  
C/JS45

473



**Eiche Struktur Natur Nachbildung**  
*Oak Structure Nature Finish*  
JSM\_

473



**Eiche Struktur Natur Nachbildung**  
*Oak Structure Nature Finish*  
M/JS55

435



**Eiche Struktur Weiß Nachbildung**  
*Oak Structure White Finish*  
JSL\_

435



**Eiche Struktur Weiß Nachbildung**  
*Oak Structure White Finish*  
L/JS40

426



**Eiche Struktur Braun Nachbildung**  
*Oak Structure Brown Finish*  
JSH\_

426



**Eiche Struktur Braun Nachbildung**  
*Oak Structure Brown Finish*  
H/JS70

### Frontfarben/front colours

### Korpusfarben/basic shell colours

#### MDF-foliert/MDF-coated

#### PG 2 Dickkante/thick edge

961

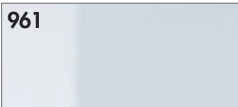

**Weiß Glanz**  
*Gloss White*  
JSG\_

286



**Weiß Seidenglanz**  
*Silk Gloss White*  
E/JS86

438



**Anthrazit Glanz**  
*Gloss Anthracite*  
JSF\_

284



**Anthrazit Seidenglanz**  
*Silk Gloss Anthracite*  
A/JS84

490



**Kastanie Graphit Nachbildung**  
*Graphite Chestnut Finish*  
C/JS45

473



**Eiche Struktur Natur Nachbildung**  
*Oak Structure Nature Finish*  
M/JS55

435



**Eiche Struktur Weiß Nachbildung**  
*Oak Structure White Finish*  
L/JS40







426





**Eiche Struktur Braun Nachbildung**  
*Oak Structure Brown Finish*  
H/JS70

# »3460marlinplan«

## Regalfarben/ shelf colours

287		<b>Weiß Seidenglanz</b> <i>Silk Gloss White</i> JS86	285		<b>Anthrazit Seidenglanz</b> <i>Silk Gloss Anthracite</i> JS84
491		<b>Kastanie Graphit Nachbildung</b> <i>Graphite Chestnut Finish</i> JS45	474		<b>Eiche Struktur Natur Nachbildung</b> <i>Oak Structure Nature Finish</i> JS55
436		<b>Eiche Struktur Weiß Nachbildung</b> <i>Oak Structure White Finish</i> JS40	427		<b>Eiche Struktur Braun Nachbildung</b> <i>Oak Structure Brown Finish</i> JS70













## Griffe/handles

	<b>Edelstahl Optik</b> <i>Stainless design</i> Griffnummer/handlenumber: 265/266/386/267/268/269/270 ⌀-⌀ 96 mm/128 mm/192 mm/256 mm/179-179 mm*/179-179 mm*/279-279 mm*
	<b>Schwarz Matt Struktur</b> <i>Matt Black Structure</i> Griffnummer/handlenumber: 272/273/271/274/275/276/277 ⌀-⌀ 96 mm/128 mm/192 mm/256 mm/179-179 mm*/179-179 mm*/279-279 mm*
	<b>Chrom Glanz</b> <i>Gloss chrome</i> Griffnummer/handlenumber: 249/255/256/257 ⌀-⌀ 69 mm/169 mm/269 mm/335-335 mm*

⌀-⌀ = Bohrabstand/ hole spacing    \*drei Grifflochbohrungen











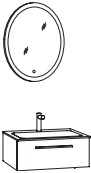

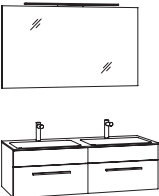

Die Angabe einer Griffnummer ist ausreichend. Die Griffe werden passend zur jeweiligen Schrankbreite beigelegt.  
The indication of one handle number is sufficient. The handles are supplied to match the respective cabinet width.

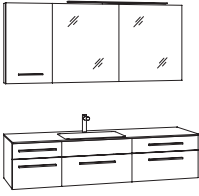
## Beleuchtung / lighting

	<b>LED</b> FLL60, FLL90	Breite/width 60 cm, 90 cm Lichtfarbe Tageslicht <i>Luminous colour natural light</i>	6000 Kelvin	
	<b>LED +</b> FLS60, FLS90	Breite/width 60 cm, 90 cm Lichtfarbe regelbar/colour temperature adjustable Helligkeit dimmbar/ brightness dimmable	2800-6500 Kelvin	
	<b>LED +</b> Wl6, Wl8	Breite/width 60 cm, 80 cm Lichtfarbe regelbar/colour temperature adjustable Helligkeit dimmbar/ brightness dimmable	2800-6500 Kelvin	
	<b>LED +</b> SLM60, SLM90	Breite/width 60 cm, 90 cm Lichtfarbe regelbar/colour temperature adjustable Helligkeit dimmbar/ brightness dimmable	2800-6500 Kelvin	
	<b>LED</b> LF70, LF110	Breite/width 70 cm, 110 cm Lichtfarbe Tageslicht <i>Luminous colour natural light</i>	6000 Kelvin	
	<b>LED</b> ASL60, ASL80	Breite/width 60 cm, 90 cm Lichtfarbe Wohlfühllicht <i>Luminous colour warm light</i>	4000 Kelvin	

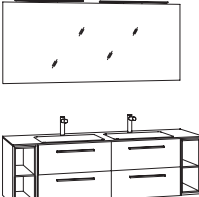









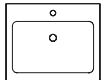

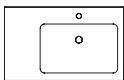

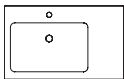

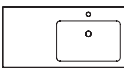

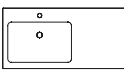

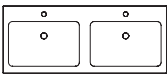
Die Steckdose / Powerbox für Spiegelschränke ist auch in Ausführung für die Schweiz / Frankreich erhältlich. Bitte Mehrpreis beachten (siehe Seite 15).  
The power socket for mirror cabinets is also available for Switzerland / France. Please note extra charge (see page 15).

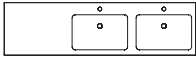

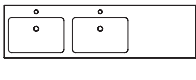

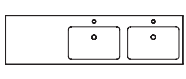

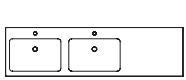



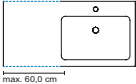

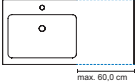
# 3460marlinplan »Beispiel-Kombinationen/example-combinations«

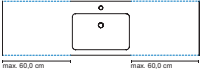
Beschreibung Description	Maße in cm Dimensions in cm			Artikel-Nr. Article no.	Türanschlag Door stop	Identnummer ID number	
	B/W	H	T/D			PG1	PG2
 <p>Kombination 60 cm bestehend aus: Spiegelpaneel, Sensorschalter Mineralmarmor-Waschtisch Waschtisch-Unterschrank, 1 Auszug Designsiphon</p> <p><i>combination 60 cm width consisting of: mirror panel, sensor switch marble minerals washbasin washbasin base cabinet, 1 extension design siphon</i></p>				<b>SPE55</b> <b>MWFLA6</b> <b>WMFS6</b> <b>DS</b>	  	<b>1131</b> <b>1546</b> <b>1131</b> <b>236</b> <hr/> <b>4044</b>	<b>1131</b> <b>1546</b> <b>1292</b> <b>236</b> <hr/> <b>4205</b>
 <p>Kombination 120 cm bestehend aus: LED Aufbauleuchte 90 cm Spiegelpaneel 120 cm Mineralmarmor-Doppelwaschtisch Waschtisch-Unterschrank, 1 feste Blende, 1 Schubkasten Waschtisch-Unterschrank, 1 feste Blende, 1 Schubkasten</p> <p><i>combination 120 cm width consisting of: LED top lighting 90 cm mirror panel, 120 cm marble mineral double washbasin washbasin base cabinet, 1 fixed panel, 1 drawer washbasin base cabinet, 1 fixed panel, 1 drawer</i></p>				<b>FLS90S</b> <b>SPOX12</b> <b>MWFLE12D</b> <b>WMFBS6</b> <b>WMFBS6</b>	 	<b>1038</b> <b>692</b> <b>2030</b> <b>1038</b> <b>1038</b> <hr/> <b>5836</b>	<b>1038</b> <b>692</b> <b>2030</b> <b>1200</b> <b>1200</b> <hr/> <b>6160</b>
 <p>Kombination 160 cm bestehend aus: LED Aufbauleuchte 90 cm Spiegelschrank 120 cm Oberschrank 40 cm Mineralmarmor-Waschtisch 160 cm links 40 cm, rechts 60 cm Ablage Waschtisch-Unterschrank, 1 feste Blende, 1 Schubkasten Unterschrank 40 cm, 1 Schubkasten, 1 Auszug Unterschrank 60 cm, 1 Schubkasten, 1 Auszug</p> <p><i>combination 160 cm width consisting of: LED top lighting 90 cm mirror cabinet 120 cm top cabinet 40 cm marble mineral washbasin 160 cm left 40 cm, right 60 cm depot washbasin base cabinet, 1 fixed panel, 1 drawer base cabinet 40 cm, 1 drawer, 1 extension base cabinet 60 cm, 1 drawer, 1 extension</i></p>				<b>FLL90</b> <b>SFX12D</b> <b>OT40DL</b> <b>MWFLAVM</b> <b>WMFBS6</b> <b>UFSA4</b> <b>UFSA6</b>	  	<b>670</b> <b>1961</b> <b>461</b> <b>2676</b>  <b>1038</b> <b>1176</b> <b>1338</b> <hr/> <b>9320</b>	<b>670</b> <b>1961</b> <b>554</b> <b>2676</b>  <b>1200</b> <b>1362</b> <b>1500</b> <hr/> <b>9923</b>
 <p>Kombination 155 cm bestehend aus: LED Aufbauleuchte 60 cm LED Aufbauleuchte 60 cm Spiegelpaneel 160 cm Mineralmarmor-Doppelwaschtisch 155 cm links 20 cm, rechts 15 cm Ablage Waschtischunterschrank 60 cm, 1 Schubkasten, 1 Auszug Waschtischunterschrank 60 cm, 1 Schubkasten, 1 Auszug Unterschrankregal 20 cm links Unterschrankregal 15 cm rechts</p> <p><i>combination 155 cm consisting of: LED top lighting 60 cm LED top lighting 60 cm mirror panel 160 cm marble mineral double washbasin 155 cm left 20 cm, right 15 cm depot washbasin base cabinet 60 cm, 1 drawer, 1 extension washbasin base cabinet 60 cm, 1 drawer, 1 extension base cabinet shelf 20 cm left base cabinet shelf 15 cm right</i></p>				<b>FLL60S</b> <b>FLL60S</b> <b>SPOX16</b> <b>MWFLEVM</b> <b>WMFSA6</b> <b>WMFSA6</b> <b>RFCV6</b> <b>RFCV6</b>	  	<b>715</b> <b>715</b> <b>830</b> <b>2999</b>  <b>1407</b> <b>1407</b> <b>767</b> <b>767</b> <hr/> <b>9607</b>	<b>715</b> <b>715</b> <b>830</b> <b>2999</b>  <b>1615</b> <b>1615</b> <b>767</b> <b>767</b> <hr/> <b>10023</b>

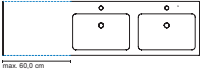
Handtuchhalter, Regale, Unterbaubeleuchtungen und weiteres Zubehör finden Sie in der Rubrik 3970zubehör.  
Towel rails, shelves, base lightings and other accessories can be found in the 3970accessories range.

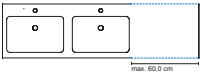
Beschreibung Description	Maße in cm Dimensions in cm			Artikel-Nr. Article no.	Türanschlag Door stop	Identnummer ID number
	B/W	H	T/D			

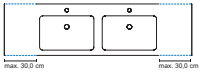
	Mineralmarmor Waschtisch inkl. Clou-Überlaufsystem  <i>marble minerals washbasin incl. Clou overflow system</i>	60,5	1,5	49,5	<b>MWFLA6</b> 	<b>1546</b>
	Mineralmarmor Waschtisch Ablage links, inkl. Clou-Überlaufsystem  <i>marble minerals washbasin depot on the left, incl. Clou overflow system</i>	80,5	1,5	49,5	<b>MWFLA8L</b> 	<b>1615</b>
	Mineralmarmor Waschtisch Ablage rechts, inkl. Clou-Überlaufsystem  <i>marble minerals washbasin depot on the right, incl. Clou overflow system</i>	80,5	1,5	49,5	<b>MWFLA8R</b> 	<b>1615</b>
	Mineralmarmor Waschtisch Ablage links, inkl. Clou-Überlaufsystem  <i>marble minerals washbasin depot on the left, incl. Clou overflow system</i>	100,5	1,5	49,5	<b>MWFLA10L</b> 	<b>1707</b>
	Mineralmarmor Waschtisch Ablage rechts, inkl. Clou-Überlaufsystem  <i>marble minerals washbasin depot on the right, incl. Clou overflow system</i>	100,5	1,5	49,5	<b>MWFLA10R</b> 	<b>1707</b>
	Mineralmarmor-Doppel-Waschtisch inkl. Clou-Überlaufsystem  <i>marble minerals double washbasin incl. Clou overflow system</i>	120,5	1,5	49,5	<b>MWFLE12D</b> 	<b>2030</b>
	Mineralmarmor-Doppel-Waschtisch Ablage links, inkl. Clou-Überlaufsystem  <i>marble minerals double washbasin depot on the left, incl. Clou overflow system</i>	160,5	1,5	49,5	<b>MWFLE16DL</b> 	<b>2514</b>
	Mineralmarmor-Doppel-Waschtisch Ablage rechts, inkl. Clou-Überlaufsystem  <i>marble minerals double washbasin depot on the right, incl. Clou overflow system</i>	160,5	1,5	49,5	<b>MWFLE16DR</b> 	<b>2514</b>
	Mineralmarmor-Doppel-Waschtisch Ablage links, inkl. Clou-Überlaufsystem  <i>marble minerals double washbasin depot on the left, incl. Clou overflow system</i>	180,5	1,5	49,5	<b>MWFLE18DL</b> 	<b>2814</b>
	Mineralmarmor-Doppel-Waschtisch Ablage rechts, inkl. Clou-Überlaufsystem  <i>marble minerals double washbasin depot on the right, incl. Clou overflow system</i>	180,5	1,5	49,5	<b>MWFLE18DR</b> 	<b>2814</b>

Beschreibung Description	Maße in cm Dimensions in cm			Artikel-Nr. Article no.	Türanschlag Door stop	Identnummer ID number
	B/W	H	T/D			
 <p>Mineralmarmor Waschtisch Ablage links, inkl. Clou-Überlaufsystem <i>marble minerals washbasin depot on the left, incl. Clou overflow system</i></p>	60,5 -120,5	1,5	49,5	MWFLAVL  	2192	
 <p>Mineralmarmor Waschtisch Ablage rechts, inkl. Clou-Überlaufsystem <i>marble minerals washbasin depot on the right, incl. Clou overflow system</i></p>	60,5 -120,5	1,5	49,5	MWFLAVR  	2192	
 <p>Mineralmarmor Waschtisch Ablage links und rechts, inkl. Clou- Überlaufsystem <i>marble minerals washbasin depot on the left and right, incl. Clou overflow system</i></p>	60,5 -180,5	1,5	49,5	MWFLAVM  	2676	
 <p>Mineralmarmor-Doppel-Waschtisch Ablage links, inkl. Clou-Überlaufsystem <i>marble minerals double washbasin depot on the left, incl. Clou overflow system</i></p>	120,5 -180,5	1,5	49,5	MWFLEVL  	2907	
 <p>Mineralmarmor-Doppel-Waschtisch Ablage rechts, inkl. Clou-Überlaufsystem <i>marble minerals double washbasin depot on the right, incl. Clou overflow system</i></p>	120,5 -180,5	1,5	49,5	MWFLEVR  	2907	
 <p>Mineralmarmor-Doppel-Waschtisch Ablage links und rechts, inkl. Clou- Überlaufsystem <i>marble minerals double washbasin depot on the left and right, incl. Clou over- flow system</i></p>	120,5 -180,5	1,5	49,5	MWFLEVM  	2999	

 Bitte nutzen Sie unsere Bestellhilfe auf Seite 18 / please use our ordering guide on page 18



Die Verlängerung ist nur in Schritten von ganzen 10 mm möglich.  
The extension is only available in steps of whole 10 mm.

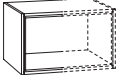
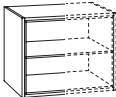

Beschreibung Description	Maße in cm Dimensions in cm			Artikel-Nr. Article no.	Türanschlag Door stop	Identnummer ID number
	B/W	H	T/D			

	Unterschrankregal variabel 1 offenes Einschubfach, inkl. Aufhängung <i>base cabinet shelf variable 1 open case, incl. hanging brackets</i>	15,0 - 23,8 60,0	46,0	<b>RFAV6</b>		<b>575</b>
	Unterschrankregal variabel 1 offenes Einschubfach, inkl. Aufhängung <i>base cabinet shelf variable 1 open case, incl. hanging brackets</i>	15,0 - 36,6 60,0	46,0	<b>RFBV6</b>		<b>671</b>
	Unterschrankregal variabel 1 offenes Einschubfach, 1 fester Einlege- boden, inkl. Aufhängung <i>base cabinet shelf variable 1 open case, 1 fixed shelf incl. hanging brackets</i>	15,0 - 47,8 60,0	46,0	<b>RFCV6</b>		<b>767</b>

Das Unterschrankregal und das offene Einschubfach können in voneinander abweichenden Dekoren bestellt werden.  
*The base cabinet shelf and the open case can be ordered in different colours.*

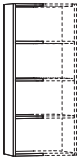

	Oberschrankregal für Spiegelschrank/- paneel 3 feste Einlegeböden, inkl. Aufhängung <b>Bei Bestellung Breite des Regals angeben!</b>  <i>wall unit shelf for mirror cabinet/- panel 3 fixed shelves, incl. mounting hange When ordering, please state the width of the shelf!</i>	15,0 - 68,2 60,0	15,6	<b>REBV</b>		<b>769</b>
--	--	---------------------	------	-------------	--	------------



Die Regale können in cm-Schritten von 15-60 cm Breite individuell bestellt werden. / *The shelves can be ordered in a width of 15 to 60 cm.*

 Regalfarben unbedingt mit angeben, Übersicht siehe Seite 3. *Please indicate shelf colours, overview see page 3.*

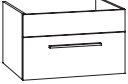
# 3460marlinplan »Waschtisch-Unterschränke / washbasin base cabinets«

Beschreibung Description	Maße in cm Dimensions in cm			Artikel-Nr. Article no.	Türanschlag Door stop	Identnummer ID number
	B/W	H	T/D			

Waschtischunterschränke mit Siphonausschnitt / washbasin base cabinet with siphon cut-out					PG1	PG2	
	Waschtisch-Unterschrank 1 Schubkasten 1 Designsiphon  <i>washbasin base cabinet 1 drawer 1 design siphon</i>	60,0	23,8	48,0	<b>WMFS6</b>	<b>1131</b>	<b>1292</b>
	Waschtisch-Unterschrank 1 feste Blende 1 Schubkasten  <i>washbasin base cabinet 1 fixed cover 1 drawer</i>	60,0	36,6	48,0	<b>WMFBS6</b>	<b>1038</b>	<b>1200</b>
	Waschtisch-Unterschrank 1 Schubkasten 1 Auszug  <i>washbasin base cabinet 1 drawer 1 extension</i>	60,0	47,8	48,0	<b>WMFSA6</b>	<b>1407</b>	<b>1615</b>

Unterschränke ohne Siphonausschnitt / base cabinet without siphon cut-out					PG1	PG2	
	Unterschrank 1 Auszug, ohne Siphonausschnitt  <i>base cabinet 1 extension without siphon cut-out</i>	40,0	23,8	48,0	<b>UFA4</b>	<b>692</b>	<b>854</b>
	Unterschrank 1 Schubkasten, 1 Auszug ohne Siphonausschnitt  <i>base cabinet 1 drawer, 1 extension without siphon cut-out</i>	40,0	36,6	48,0	<b>UFSA4</b>	<b>1176</b>	<b>1362</b>
	Unterschrank 2 Auszüge ohne Siphonausschnitt  <i>base cabinet 2 extensions without siphon cut-out</i>	40,0	47,8	48,0	<b>UFAA4</b>	<b>1223</b>	<b>1384</b>

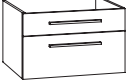
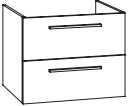
	Unterschrank 1 Auszug ohne Siphonausschnitt  <i>base cabinet 1 extension without siphon cut-out</i>	60,0	23,8	48,0	<b>UFA6</b>	<b>739</b>	<b>900</b>
	Unterschrank 1 Schubkasten 1 Auszug ohne Siphonausschnitt  <i>base cabinet 1 drawer 1 extension without siphon cut-out</i>	60,0	36,6	48,0	<b>UFSA6</b>	<b>1338</b>	<b>1500</b>
	Unterschrank 2 Auszüge ohne Siphonausschnitt  <i>base cabinet 2 extensions without siphon cut-out</i>	60,0	47,8	48,0	<b>UFAA6</b>	<b>1384</b>	<b>1546</b>

# 3460marlinplan »Spiegelschränke / mirror cabinets«

Beschreibung Description	Maße in cm Dimensions in cm			Artikel-Nr. Article no.	Türanschlag Door stop	Identnummer ID number
	B/W	H	T/D			

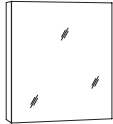
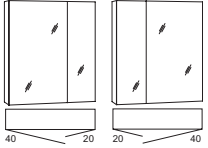
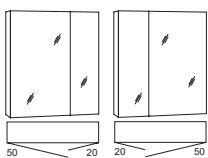
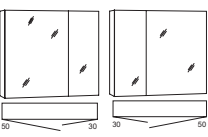
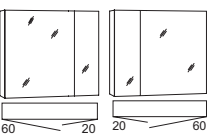
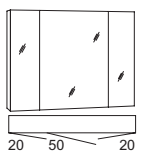
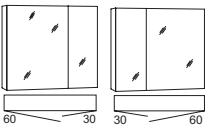
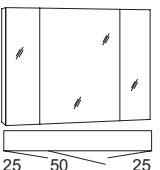
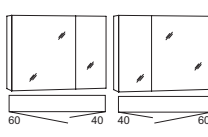
 <p>Spiegelschrank ohne Beleuchtung, 1 beidseitig verspiegelte Tür, 2 Glasein- legeböden, inkl. Schalter/Steckdose</p> <p><i>mirror cabinet without lighting, 1 door mirrored on both sides 2 glass shelves, incl. switch/socket</i></p>	60,0	68,2	17,6	<b>SFX6</b>	L/R	<b>1338</b>
 <p>Spiegelschrank ohne Beleuchtung, 2 beidseitig verspiegelte Türen, 2 Glasein- legeböden, inkl. Schalter/Steckdose</p> <p><i>mirror cabinet without lighting, 2 doors mirrored on both sides 2 glass shelves, incl. switch/socket</i></p>	60,0	68,2	17,6	<b>SFX6L</b>	40 / 20	<b>1476</b>
	60,0	68,2	17,6	<b>SFX6R</b>	20 / 40	<b>1476</b>
 <p>Spiegelschrank ohne Beleuchtung, 2 beidseitig verspiegelte Türen, 2 Glasein- legeböden, inkl. Schalter/Steckdose</p> <p><i>mirror cabinet without lighting, 2 doors mirrored on both sides 2 glass shelves, incl. switch/socket</i></p>	70,0	68,2	17,6	<b>SFX7L</b>	50 / 20	<b>1569</b>
	70,0	68,2	17,6	<b>SFX7R</b>	20 / 50	<b>1569</b>
 <p>Spiegelschrank ohne Beleuchtung, 2 beidseitig verspiegelte Türen, 2 Glasein- legeböden, inkl. Schalter/Steckdose</p> <p><i>mirror cabinet without lighting, 2 doors mirrored on both sides 2 glass shelves, incl. switch/socket</i></p>	80,0	68,2	17,6	<b>SFX8L</b>	50 / 30	<b>1661</b>
	80,0	68,2	17,6	<b>SFX8R</b>	30 / 50	<b>1661</b>
 <p>Spiegelschrank ohne Beleuchtung, 2 beidseitig verspiegelte Türen, 2 Glasein- legeböden, inkl. Schalter/Steckdose</p> <p><i>mirror cabinet without lighting, 2 doors mirrored on both sides 2 glass shelves, incl. switch/socket</i></p>	80,0	68,2	17,6	<b>SFX82L</b>	60 / 20	<b>1661</b>
	80,0	68,2	17,6	<b>SFX82R</b>	20 / 60	<b>1661</b>
 <p>Spiegelschrank ohne Beleuchtung, 3 beidseitig verspiegelte Türen, 4 Glasein- legeböden, inkl. Schalter/Steckdose</p> <p><i>mirror cabinet without lighting, 3 doors mirrored on both sides 4 glass shelves, incl. switch/socket</i></p>	90,0	68,2	17,6	<b>SFX9</b>	20 / 50 / 20	<b>1937</b>
 <p>Spiegelschrank ohne Beleuchtung, 2 beidseitig verspiegelte Türen, 2 Glasein- legeböden, inkl. Schalter/Steckdose</p> <p><i>mirror cabinet without lighting, 2 doors mirrored on both sides 2 glass shelves, incl. switch/socket</i></p>	90,0	68,2	17,6	<b>SFX9L</b>	60 / 30	<b>1753</b>
	90,0	68,2	17,6	<b>SFX9R</b>	30 / 60	<b>1753</b>
 <p>Spiegelschrank ohne Beleuchtung, 3 beidseitig verspiegelte Türen, 4 Glasein- einlegeböden, inkl. Schalter/Steckdose</p> <p><i>mirror cabinet without lighting, 3 doors mirrored on both sides 4 glass shelves, incl. switch/socket</i></p>	100,0	68,2	17,6	<b>SFX10</b>	25 / 50 / 25	<b>2030</b>
 <p>Spiegelschrank ohne Beleuchtung, 2 beidseitig verspiegelte Türen, 2 Glasein- legeböden, inkl. Schalter/Steckdose</p> <p><i>mirror cabinet without lighting, 2 doors mirrored on both sides 2 glass shelves, incl. switch/socket</i></p>	100,0	68,2	17,6	<b>SFX10L</b>	60 / 40	<b>1846</b>
	100,0	68,2	17,6	<b>SFX10R</b>	40 / 60	<b>1846</b>

# 3460marlinplan »Spiegelschränke / mirror cabinets«

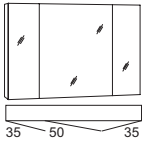
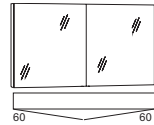
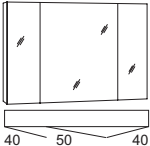
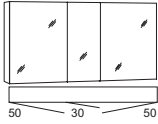
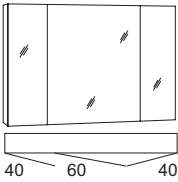
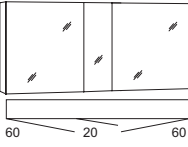
Beschreibung Description	Maße in cm Dimensions in cm			Artikel-Nr. Article no.	Türanschlag Door stop	Identnummer ID number
	B/W	H	T/D			
 <p>Spiegelschrank ohne Beleuchtung, 3 beidseitig verspiegelte Türen 4 Glaseinlegeböden, inkl. Schalter/ Steckdose</p> <p><i>mirror cabinet without lighting, 3 doors mirrored on both sides 4 glass shelves, incl. switch/socket</i></p>	120,0	68,2	17,6	<b>SFX12</b>	35 / 50 / 35	<b>2123</b>
 <p>Spiegelschrank ohne Beleuchtung, 2 beidseitig verspiegelte Türen 4 Glaseinlegeböden, inkl. Schalter/ Steckdose</p> <p><i>mirror cabinet without lighting, 2 doors mirrored on both sides 4 glass shelves, incl. switch/socket</i></p>	120,0	68,2	17,6	<b>SFX12D</b>	60 / 60	<b>1961</b>
 <p>Spiegelschrank ohne Beleuchtung, 3 beidseitig verspiegelte Türen 4 Glaseinlegeböden, inkl. Schalter/ Steckdose</p> <p><i>mirror cabinet without lighting, 3 doors mirrored on both sides 4 glass shelves, incl. switch/socket</i></p>	130,0	68,2	17,6	<b>SFX13</b>	40 / 50 / 40	<b>2168</b>
 <p>Spiegelschrank ohne Beleuchtung, 3 beidseitig verspiegelte Türen 4 Glaseinlegeböden, inkl. Schalter/ Steckdose</p> <p><i>mirror cabinet without lighting, 3 doors mirrored on both sides 4 glass shelves, incl. switch/socket</i></p>	130,0	68,2	17,6	<b>SFX13D</b>	50 / 30 / 50	<b>2168</b>
 <p>Spiegelschrank ohne Beleuchtung, 3 beidseitig verspiegelte Türen 4 Glaseinlegeböden, inkl. Schalter/ Steckdose</p> <p><i>mirror cabinet without lighting, 3 doors mirrored on both sides 4 glass shelves, incl. switch/socket</i></p>	140,0	68,2	17,6	<b>SFX14</b>	40 / 60 / 40	<b>2261</b>
 <p>Spiegelschrank ohne Beleuchtung, 3 beidseitig verspiegelte Türen 4 Glaseinlegeböden, inkl. Schalter/ Steckdose</p> <p><i>mirror cabinet without lighting, 3 doors mirrored on both sides 4 glass shelves, incl. switch/socket</i></p>	140,0	68,2	17,6	<b>SFX14M</b>	60 / 20 / 60	<b>2261</b>

# 3460marlinplan »Spiegelschränke / mirror cabinets«



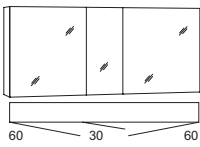
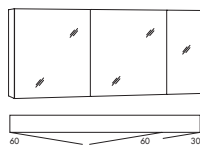
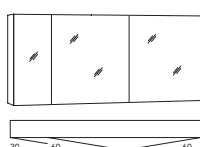
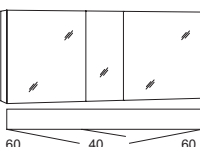
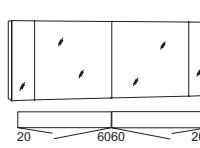









Beschreibung Description	Maße in cm Dimensions in cm			Artikel-Nr. Article no.	Türanschlag Door stop	Identnummer ID number
	B/W	H	T/D			

 <p>Spiegelschrank, ohne Beleuchtung, 3 beidseitig verspiegelte Türen 4 Glaseinlegeböden, inkl. Schalter/ Steckdose</p> <p><i>mirror cabinet without lighting, 3 doors mirrored on both sides 4 glass shelves, incl. switch/socket</i></p>	150,0	68,2	17,6	<b>SFX15</b>	60 / 30 / 60	<b>2423</b>
 <p>Spiegelschrank, ohne Beleuchtung, 3 beidseitig verspiegelte Türen 6 Glaseinlegeböden, inkl. Schalter/ Steckdose</p> <p><i>mirror cabinet without lighting, 3 doors mirrored on both sides 6 glass shelves, incl. switch/socket</i></p>	150,0	68,2	17,6	<b>SFX15L</b>	60 / 60 / 30	<b>2423</b>
 <p>Spiegelschrank, ohne Beleuchtung, 3 beidseitig verspiegelte Türen 6 Glaseinlegeböden, inkl. Schalter/ Steckdose</p> <p><i>mirror cabinet without lighting, 3 doors mirrored on both sides 6 glass shelves, incl. switch/socket</i></p>	150,0	68,2	17,6	<b>SFX15R</b>	30 / 60 / 60	<b>2423</b>
 <p>Spiegelschrank, ohne Beleuchtung, 3 beidseitig verspiegelte Türen 4 Glaseinlegeböden, inkl. Schalter/ Steckdose</p> <p><i>mirror cabinet without lighting, 3 doors mirrored on both sides 4 glass shelves, incl. switch/socket</i></p>	160,0	68,2	17,6	<b>SFX16</b>	60 / 40 / 60	<b>2514</b>
 <p>Spiegelschrank, ohne Beleuchtung, 4 beidseitig verspiegelte Türen 4 Glaseinlegeböden, inkl. 2x Schalter/ Steckdose</p> <p><i>mirror cabinet without lighting, 4 doors mirrored on both sides 4 glass shelves, incl. 2x switch/socket</i></p>	160,0	68,2	17,6	<b>SFX16D</b>	20/60/60/20	<b>3229</b>

Beschreibung Description	Maße in cm Dimensions in cm			Artikel-Nr. Article no.	Türanschlag Door stop	Identnummer ID number
	B/W	H	T/D			
 <p>Spiegelpaneel ohne Beleuchtung, Schalter mittig für 2 Lichtfarben <i>mirror panel without lighting, switch center for 2 luminous colours</i></p>	60,0	68,2	2,8	<b>SPOX6</b>		<b>461</b>
 <p>Spiegelpaneel ohne Beleuchtung, Schalter mittig für 2 Lichtfarben <i>mirror panel without lighting, switch center for 2 luminous colours</i></p>	70,0	68,2	2,8	<b>SPOX7</b>		<b>508</b>
 <p>Spiegelpaneel ohne Beleuchtung, Schalter mittig für 2 Lichtfarben <i>mirror panel without lighting, switch center for 2 luminous colours</i></p>	80,0	68,2	2,8	<b>SPOX8</b>		<b>554</b>
 <p>Spiegelpaneel ohne Beleuchtung, Schalter mittig für 2 Lichtfarben <i>mirror panel without lighting, switch center for 2 luminous colours</i></p>	90,0	68,2	2,8	<b>SPOX9</b>		<b>600</b>
 <p>Spiegelpaneel ohne Beleuchtung, Schalter mittig für 2 Lichtfarben <i>mirror panel without lighting, switch center for 2 luminous colours</i></p>	100,0	68,2	2,8	<b>SPOX10</b>		<b>646</b>
 <p>Spiegelpaneel ohne Beleuchtung, Schalter mittig für 2 Lichtfarben <i>mirror panel without lighting, switch center for 2 luminous colours</i></p>	120,0	68,2	2,8	<b>SPOX12</b>		<b>692</b>
 <p>Spiegelpaneel ohne Beleuchtung, Schalter mittig für 2 Lichtfarben <i>mirror panel without lighting, switch center for 2 luminous colours</i></p>	130,0	68,2	2,8	<b>SPOX13</b>		<b>739</b>
 <p>Spiegelpaneel ohne Beleuchtung, Schalter mittig für 2 Lichtfarben <i>mirror panel without lighting, switch center for 2 luminous colours</i></p>	140,0	68,2	2,8	<b>SPOX14</b>		<b>785</b>
 <p>Spiegelpaneel ohne Beleuchtung, Schalter mittig für 2 Lichtfarben <i>mirror panel without lighting, switch center for 2 luminous colours</i></p>	160,0	68,2	2,8	<b>SPOX16</b>		<b>830</b>

**Aufgrund des Schalters auf der Unterseite können unter diese Spiegelpaneele keine Regale geplant werden.**  
*Due to the switch beneath the mirror no shelves can be planned below these mirror panels.*









# 3460marlinplan »Aufbauleuchten / top lighting«

Beschreibung Description	Maße in cm Dimensions in cm			Artikel-Nr. Article no.	Identnummer ID number
	B/W	H	T/D		
 <p>LED Aufbauleuchte 4000 K, 5,8 W, 248 Lumen, EEK F</p> <p><i>LED top light 4000 K, 5,8 W, 248 lumen, EEK F</i></p>	60,0	4,0	7,0	<b>ASL60</b> für Spiegelschränke / <i>for mirror cabinets</i> <b>ASL60S</b> für Spiegelpaneele / <i>for mirror panels</i>	<b>162</b> <b>300</b>
		<b>NEW</b>		 Dieses Produkt enthält eine Lichtquelle der Energieeffizienzklasse F	
 <p>LED Aufbauleuchte 4000 K, 7,8 W, 331 Lumen, EEK F</p> <p><i>LED top light 4000 K, 7,8 W, 331 lumen, EEK F</i></p>	80,0	4,0	7,0	<b>ASL80</b> für Spiegelschränke / <i>for mirror cabinets</i> <b>ASL80S</b> für Spiegelpaneele / <i>for mirror panels</i>	<b>184</b> <b>323</b>
		<b>NEW</b>		 Dieses Produkt enthält eine Lichtquelle der Energieeffizienzklasse F	
 <p>LED Aufbauleuchte 6000 K, 11,5 W, 1168 Lumen, EEK E</p> <p><i>LED top light 6000 K, 11,5 W, 1168 lumen, EEK E</i></p>	60,0	2,5	8,0	<b>FLL60</b> für Spiegelschränke / <i>for mirror cabinets</i> <b>FLL60S</b> für Spiegelpaneele / <i>for mirror panels</i>	<b>600</b> <b>715</b>
				 Dieses Produkt enthält eine Lichtquelle der Energieeffizienzklasse E	
 <p>LED Aufbauleuchte 6000 K, 17,0 W, 1751 Lumen, EEK E</p> <p><i>LED top light 6000 K, 17,0 W, 1751 lumen, EEK E</i></p>	90,0	2,5	8,0	<b>FLL90</b> für Spiegelschränke / <i>for mirror cabinets</i> <b>FLL90S</b> für Spiegelpaneele / <i>for mirror panels</i>	<b>670</b> <b>830</b>
				 Dieses Produkt enthält eine Lichtquelle der Energieeffizienzklasse E	
 <p>LED Aufbauleuchte 2800-6500 K, 12 W, 926 Lumen, EEK G</p> <p><i>LED top light 2800-6500 K, 12 W, 926 lumen, EEK G</i></p>	60,0	2,5	8,0	<b>FLS60</b> für Spiegelschränke / <i>for mirror cabinets</i> <b>FLS60S</b> für Spiegelpaneele / <i>for mirror panels</i>	<b>808</b> <b>923</b>
				 Dieses Produkt enthält eine Lichtquelle der Energieeffizienzklasse G	
 <p>LED Aufbauleuchte 2800-6500 K, 17,5 W, 1390 Lumen, EEK G</p> <p><i>LED top light 2800-6500 K, 17,5 W, 1390 lumen, EEK G</i></p>	90,0	2,5	8,0	<b>FLS90</b> für Spiegelschränke / <i>for mirror cabinets</i> <b>FLS90S</b> für Spiegelpaneele / <i>for mirror panels</i>	<b>877</b> <b>1038</b>
				 Dieses Produkt enthält eine Lichtquelle der Energieeffizienzklasse G	

**Unsere Spiegelschränke werden mit passendem Trafo geliefert. Daher enthalten nur die Beleuchtungen für Spiegelpaneele einen Trafo. Bei Bestellung einer Beleuchtung ohne MARLIN-Spiegelschrank daher bitte die Version für Spiegelpaneele wählen.**  
*Our mirror cabinets are supplied with a matching converter. Therefore only the mirror panel lights include a separate converter. Choose the mirror panel version when ordering a top light without a MARLIN mirror cabinet.*

EEK/EEC=Energieeffizienzklasse/energy efficiency category  
 Leuchtmittel sind nicht austauschbar / illuminants are not interchangeable.

# 3460marlinplan »Aufbauleuchten / top lighting«

Beschreibung Description	Maße in cm Dimensions in cm			Artikel-Nr. Article no.	Identnummer ID number
	B/W	H	T/D		
 <p>LED Aufbauleuchte 2800-6500 K, 5,6 W, 452 Lumen, EEK G</p> <p>LED top light 2800-6500 K, 5,6 W, 452 lumen, EEC G</p>	60,0	1,5	5,0	<b>SLM60</b> für Spiegelschränke / for mirror cabinets <b>SLM60S</b> für Spiegelpaneele / for mirror panels  Dieses Produkt enthält eine Lichtquelle der Energieeffizienzklasse G	<b>300</b> <b>415</b>
				<b>SLM90</b> für Spiegelschränke / for mirror cabinets <b>SLM90S</b> für Spiegelpaneele / for mirror panels  Dieses Produkt enthält eine Lichtquelle der Energieeffizienzklasse G	<b>392</b> <b>508</b>
 <p>LED Aufbauleuchte 6000 K, 6,3 W, 817 Lumen, EEK F</p> <p>LED top light 6000 K, 6,3 W, 817 lumen, EEC F</p>	70,0	3,5	11,0	<b>LF70</b> für Spiegelschränke / for mirror cabinets <b>LF70S</b> für Spiegelpaneele / for mirror panels  Dieses Produkt enthält eine Lichtquelle der Energieeffizienzklasse F	<b>854</b> <b>969</b>
				<b>LF110</b> für Spiegelschränke / for mirror cabinets <b>LF110S</b> für Spiegelpaneele / for mirror panels  Dieses Produkt enthält eine Lichtquelle der Energieeffizienzklasse F	<b>1107</b> <b>1269</b>
 <p>LED Aufbauleuchte 2800-6500 K, 16,7 W, 1487 Lumen, EEK F</p> <p>LED top light 2800-6500 K, 16,7 W, 1487 lumen, EEC F</p>	60,0	1,8	17,4	<b>W16</b> für Spiegelschränke / for mirror cabinets <b>W16S</b> für Spiegelpaneele / for mirror panels  Dieses Produkt enthält eine Lichtquelle der Energieeffizienzklasse F	<b>623</b> <b>785</b>
				<b>W18</b> für Spiegelschränke / for mirror cabinets <b>W18S</b> für Spiegelpaneele / for mirror panels  Dieses Produkt enthält eine Lichtquelle der Energieeffizienzklasse F	<b>854</b> <b>1016</b>

Unsere Spiegelschränke werden mit passendem Trafo geliefert. Daher enthalten nur die Beleuchtungen für Spiegelpaneele einen Trafo. Bei Bestellung einer Beleuchtung ohne MARLIN-Spiegelschrank daher bitte die Version für Spiegelpaneele wählen.  
 Our mirror cabinets are supplied with a matching converter. Therefore only the mirror panel lights include a separate converter. Choose the mirror panel version when ordering a top light without a MARLIN mirror cabinet.

EEK/EEC=Energieeffizienzklasse/energy efficiency category  
 Leuchtmittel sind nicht austauschbar / illuminants are not interchangeable.



# 3460marlinplan »Spiegelpaneele und Zubehör/ mirror panels and accessoires«

Beschreibung Description	Maße in cm Dimensions in cm			Artikel-Nr. Article no.	Türanschlag Door stop	Identnummer ID number
	B/W	H	T/D			
 <p>Spiegelpaneel, Sensorschalter, satiniert, LED Beleuchtung, 4000 K, 17,3 W, 2415 Lumen, EEK G <b>Helligkeit dimmbar</b></p> <p><i>mirror panel, sensor switch, satined, LED-lighting, 4000 K, 17,3 W, 2415 lumen, EEC G</i> <b>brighthness dimmable</b></p>	55,0	78,0	2,8	<b>SPE55</b>	  <p>Dieses Produkt enthält eine Lichtquelle der Energieeffizienzklasse G</p>	<b>1131</b>
 <p>Spiegelpaneel, Sensorschalter, satiniert, LED Beleuchtung, 4000 K, 13,5 W, 1890 Lumen, EEK G <b>Helligkeit dimmbar</b></p> <p><i>mirror panel, sensor switch, satined, LED-lighting, 4000 K, 13,5 W, 1890 lumen, EEC G</i> <b>brighthness dimmable</b></p>	55,0	55,0	2,8	<b>SPK55</b>	  <p>Dieses Produkt enthält eine Lichtquelle der Energieeffizienzklasse G</p>	<b>992</b>
 <p>Spiegelpaneel, Sensorschalter, satiniert, LED Beleuchtung, 4000 K, 20,8 W, 2905 Lumen, EEK G <b>Helligkeit dimmbar</b></p> <p><i>mirror panel, sensor switch, satined, LED-lighting, 4000 K, 20,8 W, 2905 lumen, EEC G</i> <b>brighthness dimmable</b></p>	78,0	78,0	2,8	<b>SPK78</b>	  <p>Dieses Produkt enthält eine Lichtquelle der Energieeffizienzklasse G</p>	<b>1292</b>
 <p>Schubkasteneinsatz (Kunststoff) für oberen Auszug vom WT-Unterschrank</p> <p><i>drawer insert part (plastic) for top drawer from base cabinet</i></p>	33,7	4,3	33,0	<b>SMBEG3</b>		<b>69</b>
 <p>Steckdose/Powerbox für Spiegelschränke Ausführung <b>Schweiz</b> IP44 mit USB-C Stecker</p> <p><i>Power socket for mirror cabinets Switzerland type IP44 with USB-C plug</i></p>					<b>Mehrpreis extra charge</b>	<b>138</b>
 <p>Steckdose/Powerbox für Spiegelschränke Ausführung <b>Frankreich</b> mit USB-C Stecker</p> <p><i>Power socket for mirror cabinets France type with USB-C plug</i></p>					<b>Mehrpreis extra charge</b>	<b>138</b>

EEK/EEC=Energieeffizienzklasse/energy efficiency category  
Leuchtmittel sind nicht austauschbar / illuminants are not interchangeable.

**i** Weiteres Zubehör finden Sie im Register 3970 und Beistellschränke im Register 3990.  
Further accessoires can be found in register 3970 and side cabinets in register 3990.



# BESTELLUNG

www.marlinbad.de | info@jaka-bkl.de | Fax +49 (0) 5773/88224



Firma _____	Datum _____
Straße _____	Verkäufer _____
Ort _____	Liefertermin _____
Telefon _____	Programm/Front _____
Kunden-Nr. _____	Griff _____
Kommission _____	Korpus _____
Lieferanschrift _____	

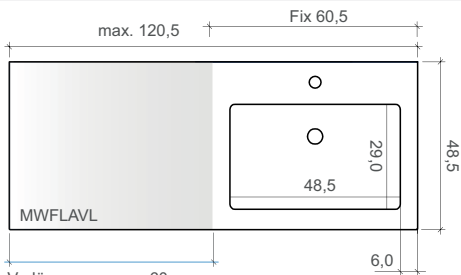

Verlängerung max. 60 cm  
Schrittweise in 1 cm

Mein Maß: \_\_\_\_\_

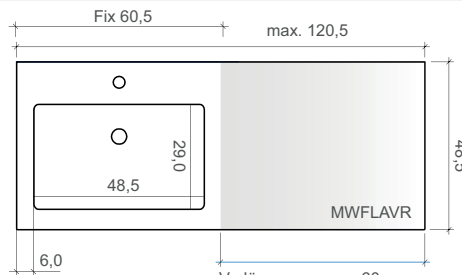

Verlängerung max. 60 cm  
Schrittweise in 1 cm

Mein Maß: \_\_\_\_\_

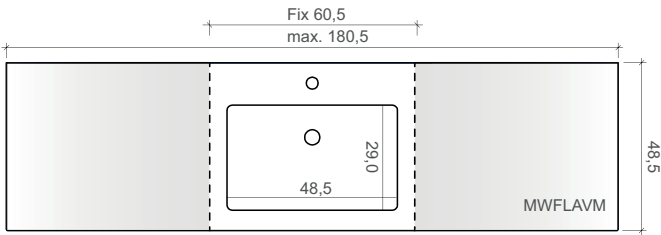

Verlängerung max. 60 cm  
Schrittweise in 1 cm

Mein Maß: \_\_\_\_\_

Verlängerung max. 60 cm  
Schrittweise in 1 cm

Mein Maß: \_\_\_\_\_

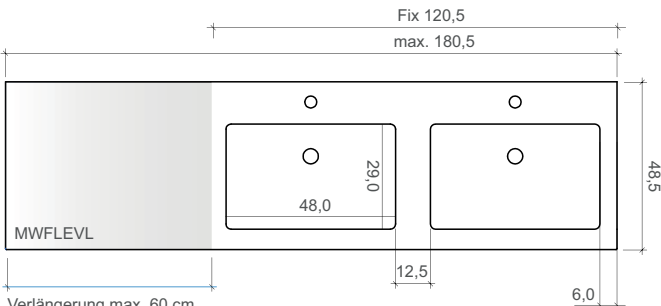

Verlängerung max. 60 cm  
Schrittweise in 1 cm

Mein Maß: \_\_\_\_\_

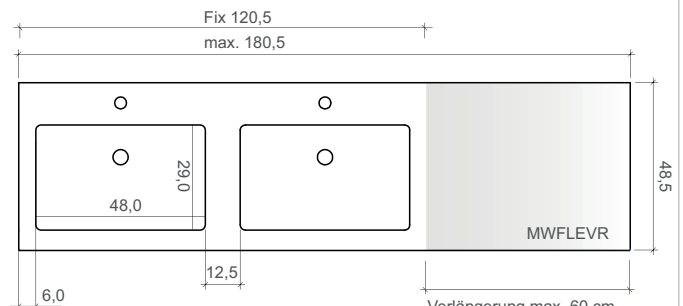

Verlängerung max. 60 cm  
Schrittweise in 1 cm

Mein Maß: \_\_\_\_\_

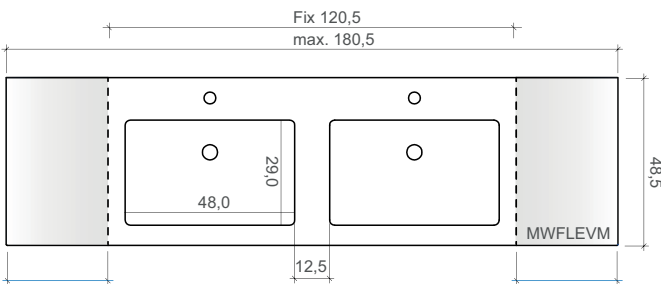

Verlängerung max. 30 cm  
Schrittweise in 1 cm

Mein Maß: \_\_\_\_\_

Verlängerung max. 30 cm  
Schrittweise in 1 cm

Mein Maß: \_\_\_\_\_



# MÖBELWASCHTISCHE FURNITURE WASCHBASIN







# 3020life







## Piktogramme/pictograms



Mineralmarmor Waschtisch  
Marble minerals washbasin



LED Lichtfarbe kalt  
LED colour temperature cold



LED mit Sensorschalter,  
Helligkeit dimmbar  
LED with sensor switch,  
brightness dimmable



Keramik Waschtisch  
Ceramic washbasin



LED Lichtfarbe warm  
LED colour temperature warm

## Mineralmarmor Waschtisch weiß alpin Glanz Marble minerals washbasin gloss alpine white

≈ Beckenmaße in cm (BxHxD)  
basin dimensions in cm (WxHxD)

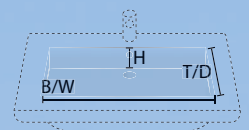

MWIDE6 | 56 x 12 x 30 cm



MWIDE8 | 68 x 12 x 30 cm



Detail



MWIDE10 | 68 x 12 x 30 cm

### Mineralmarmor Glanz/gloss marble minerals

PG1



**Weiß Alpin Glanz**  
Gloss Alpine White  
LF69

Bei granitfarbigen Waschtischen kann es zu Farbabweichungen kommen, da der Gelcoat die Farbgebung maßgeblich beeinflusst und sich im Laufe der Zeit die Farbe durch Lichteinflüsse (Sonneneinstrahlung) verändern kann.  
Colour deviations may occur with granite-coloured washbasins and the colour may change over time due to the influence of direct sunlight.

PG2



**Granit Weiß Glimmer**  
White Granite Glimmer  
LF74



**Granit Grau Glimmer**  
Grey Granite Glimmer  
LF73

## Keramik Waschtisch weiß alpin Glanz (LFK) Ceramic washbasin gloss alpine white (LFK)

 ≈ Beckenmaße in cm (BxHxT)  
basin dimensions in cm (WxHxD)

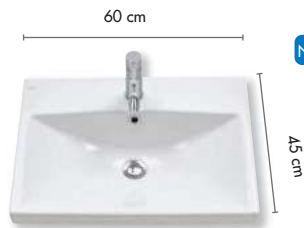
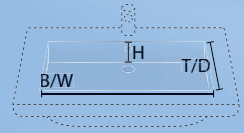

KWELI60 |  55 x 12 x 30 cm

NEW



KWELI80 |  75 x 12 x 30 cm



Detail



KWELI100 |  95 x 12 x 30 cm

**! Immer im Lieferumfang der Keramikwaschtische enthalten: Befestigungsmaterial MONK-4**  
**Always included in the scope of delivery of the ceramic washbasins: mounting material MONK-4**

Wir empfehlen eine Montage nur durch einen qualifizierten Monteur/Installateur. Keine Haftung bei unsachgemäßer Montage.  
MONK-4: 2 Stockschrauben M10x120 inkl. Dübel für massive Steinwand. Bei anderen Wandbeschaffenheiten müssen im Fachhandel entsprechende Dübel erworben werden.

We recommend installation only by a qualified fitter / installer. No liability for improper installation.  
MONK-4: 2 screws M10x120 including dowels for a solid stone wall. For other wall conditions, suitable dowels must be purchased from a specialised dealer.

## Schränke/cabinets 3020life

### Frontfarben/front colours

#### Dickkante/thick edge

286



**Weiß Seidenglanz**  
Silk Gloss White  
LFM\_

284



**Anthrazit Seidenglanz**  
Silk Gloss Anthracite  
LFA\_

490



**Kastanie Graphit Nachbildung** NEW  
Graphite Chestnut Finish  
LFZ\_

473



**Eiche Struktur Natur Nachbildung**  
Oak Structure Nature Finish  
LFX\_

435



**Eiche Struktur Weiß Nachbildung** NEW  
Oak Structure White Finish  
LFL\_

426



**Eiche Struktur Braun Nachbildung** NEW  
Oak Structure Brown Finish  
LFH\_

#### MDF-foliert/MDF-coated

952



**Rot Glanz** NEW  
Gloss Red  
LFY\_

961



**Weiß Glanz**  
Gloss White  
LFG\_

438



**Anthrazit Glanz**  
Gloss Anthracite  
LFF\_

## Korpusfarben/basic shell colours

#### PG 1 Dickkante/thick edge

286



**Weiß Seidenglanz**  
Silk Gloss White  
E/LF86

284



**Anthrazit Seidenglanz**  
Silk Gloss Anthracite  
A/LF84

490



**Kastanie Graphit Nachbildung**  
Graphite Chestnut Finish  
C/LF45

473



**Eiche Struktur Natur Nachbildung**  
Oak Structure Nature Finish  
M/LF55

435



**Eiche Struktur Weiß Nachbildung** NEW  
Oak Structure White Finish  
L/LF40

426



**Eiche Struktur Braun Nachbildung** NEW  
Oak Structure Brown Finish  
H/LF70

#### PG 3 MDF-foliert/MDF-coated

042



**Weiß Glanz Folie**  
Gloss White  
G/LF50

438



**Anthrazit Glanz Folie**  
Gloss Anthracite  
F/LF30

#### ! BITTE BEACHTEN:

Die Front-/Korpuskombination „MDF-folierte Front (Variante: 952/961/438)“ mit „Korpus PG1 (Variante: 284/286/490/473/435/426)“ wird zu PG2 abgerechnet.

The front / basic shell combination „MDF-foiled front (variant: 952/961/438)“ with „basic shell PG1 (variant: 284/286/490/473/435/426)“ is billed to PG2.

## Griffe/handles



**Chrom Glanz**  
Gloss Chrome  
Griffnummer/handlenumber: 193/187  
⌀-⌀ 96 mm/460 mm



**Schwarz Matt Struktur** NEW  
Matt Black Structure  
Griffnummer/handlenumber: 237/238  
⌀-⌀ 128 mm/320 mm

⌀-⌀ = Bohrabstand/hole spacing

**Die Angabe einer Griffnummer ist ausreichend. Die Griffe werden passend zur jeweiligen Schrankbreite beigelegt.**  
The indication of one handle number is sufficient. The handles are supplied to match the respective cabinet width.

## Beleuchtung / lighting



**Aufbauleuchte LED**  
Top light LED



**Aufbauleuchte LED**  
Top light LED



**Aufbauleuchte LED**  
Top light LED

**Lichtfarbe Tageslicht (Kalt)**  
Luminous colour natural light (cold)



LL54, LL74,  
LL94

**Lichtfarbe Wohlfühllicht (Warm)**  
Luminous colour warm light











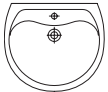

ASL60,  
ASL80



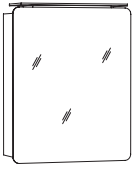
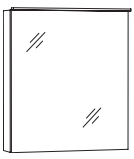
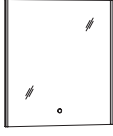









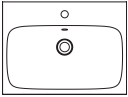

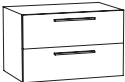
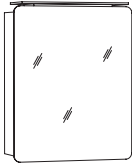
AWP60,  
AWP80,  
AWP100

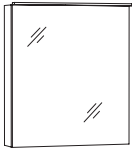
**Die Steckdose / Powerbox für Spiegelschränke ist auch in Ausführung für die Schweiz / Frankreich erhältlich. Bitte Mehrpreis beachten (siehe Seite 14).**  
The power socket for mirror cabinets is also available for Switzerland / France. Please note extra charge (see page 14).

# 3020life »60 cm Keramik kundeneigener WT/ceramic customer wb«

Beschreibung Description	Maße in cm Dimensions in cm			Artikel-Nr. Article no.	Türanschlag Door stop	Identnummer ID number		
	B/W	H	T/D			PG1	PG2	PG3
 <p>Keramik-Waschtisch inkl. Überlauf und Befestigungsmaterial</p> <p><i>ceramic washbasin incl. overflow and mounting material</i></p>	60,0	23,0	49,5	<b>KW6</b>		<b>323</b>		
 <p>Waschtisch-Unterschrank 2 Türen für kundeneigenen Keramik- Waschtisch</p> <p><i>washbasinbase cabinet 2 doors for customers own ceramic washbasin</i></p>	60,0	49,4	34,8	<b>WNLT6</b>		<b>439</b>	<b>530</b>	<b>670</b>
 <p>Sockelfuß 4 x 4 cm silbergrau, Höhenausgleich bis 2 cm je 2 Stück/Pack</p> <p><i>base foot 4 x 4 cm silver-grey, height adjustment up to 2 cm, 2 pieces/pack</i></p>	4,0	12,0/ 14,0	4,0	<b>SPE12</b>		<b>139</b>		
<p><b>Aufbauleuchte/top light</b></p>  <p>Spiegelschrank, 1 Spiegeltür 2 Glaseinlegeböden, inkl. Schalter/ Steckdose, LED-Aufbauleuchte LL54, 6000 K, 4,3 W, 518 Lumen, EEK E</p> <p><i>mirror cabinet, 1 mirror door 2 glass boards, incl. switch/socket, LED lighting LL54, 6000 K, 4,3 W, 518 lumen, EEK E</i></p>	60,0	74,2	17,6	<b>SLE6L</b> <b>SLE6R</b>	Links/ <i>left</i> Rechts/ <i>right</i>	<b>1079</b>		
<p><b>Aufbauleuchte/top light</b></p>  <p>Spiegelschrank, 1 Spiegeltür mit aufgeklebtem Innenspiegel, 2 Glaseinlegeböden, inkl. Schalter/ Steckdose, LED-Aufbauleuchte ASL60, 4000 K, 5,8 W, 248 Lumen, EEK F</p> <p><i>mirror cabinet, 1 mirror door with glued-on interior mirror, 2 glass boards, incl. switch/socket, LED lighting ASL60, 4000 K, 5,8 W, 248 lumen, EEK F</i></p>	60,0	68,2	17,6	<b>SASL6LS</b> <b>SASL6RS</b>	Links/ <i>left</i> Rechts/ <i>right</i>	<b>900</b>		
 <p>Spiegelpaneel, Sensorschalter, seitliche LED-Beleuchtung 6000 K, 2x 6,3 W, 2x 660 Lumen, EEK F <b>Helligkeit dimmbar</b></p> <p><i>mirror panel, sensor switch, lateral LED-lighting 6000 K, 2x 6,3 W, 2x 660 lumen, EEK F <b>brightness dimmable</b></i></p>	60,0	68,2	2,8	<b>SPBSA6</b>	 	<b>1107</b>		
 <p>LED-Aufbauleuchte für Spiegelpaneel mit LED-Mini-Stecker, 6000 K, 8,6 W, 792 Lumen, EEK E <b>Helligkeit dimmbar</b></p> <p><i>LED-lighting for mirror panel with LED-mini-plug, 6000 K, 8,6 W, 792 lumen, EEK E <b>brightness dimmable</b></i></p>	60,0	2,4	10,0	<b>AWP60</b>	 	<b>323</b>		

EEK/EEC=Energieeffizienzklasse/energy efficiency category  
Leuchtmittel sind nicht austauschbar / illuminants are not interchangeable.



Beschreibung Description	Maße in cm Dimensions in cm			Artikel-Nr. Article no.	Türanschlag Door stop	Identnummer ID number			
	B/W	H	T/D			PG1 Weiß alpin/gloss alpine	PG2 Granit/granite	PG3	
 <p>Mineralmarmor-Waschtisch inkl. Überlauf <i>marble minerals washbasin incl. overflow</i></p>	60,5	1,5	45,0	<b>MWIDE6</b> 			<b>761</b>	<b>1038</b>	
		<b>NEW</b>							
							<b>PG1</b>	<b>PG2</b>	<b>PG3</b>
 <p>Waschtisch-Unterschrank 2 Türen <i>washbasin base cabinet 2 doors</i></p>	60,0	47,8	44,5	<b>WMUT6</b>			<b>439</b>	<b>530</b>	<b>670</b>
		<b>NEW</b>							
 <p>Waschtisch-Unterschrank 2 Auszüge <i>washbasin base cabinet 2 extensions</i></p>	60,0	47,8	44,5	<b>WMUAA6</b>			<b>785</b>	<b>877</b>	<b>946</b>
		<b>NEW</b>							
<b>Aufbauleuchte/top light</b>									
 <p>Spiegelschrank, 1 Spiegeltür 2 Glaseinlegeböden, inkl. Schalter/ Steckdose, LED-Aufbauleuchte LL54, 6000 K, 4,3 W, 518 Lumen, EEK E  <i>mirror cabinet, 1 mirror door 2 glass boards, incl. switch/socket, LED lighting LL54, 6000 K, 4,3 W, 518 lumen, EEC E</i></p>	60,0	74,2	17,6	<b>SLE6L</b> <b>SLE6R</b>  ehemals FSPSR60L FSPSR60R 	Links/left Rechts/right		<b>1079</b>		
<b>Aufbauleuchte/top light</b>									
 <p>Spiegelschrank, 1 Spiegeltür mit aufgeklebtem Innenspiegel, 2 Glaseinlegeböden, inkl. Schalter/ Steckdose, LED-Aufbauleuchte ASL60, 4000 K, 5,8 W, 248 Lumen, EEK F  <i>mirror cabinet, 1 mirror door with glued-on interior mirror, 2 glass boards, incl. switch/socket, LED lighting ASL60, 4000 K, 5,8 W, 248 lumen, EEC F</i></p>	60,0	68,2	17,6	<b>SASL6LS</b> <b>SASL6RS</b> 	Links/left Rechts/right		<b>900</b>		
		<b>NEW</b>							
 <p>Spiegelpanel, Sensorschalter, seitliche LED-Beleuchtung 6000 K, 2x 6,3 W, 2x 660 Lumen, EEK F <b>Helligkeit dimmbar</b>  <i>mirror panel, sensor switch, lateral LED-lighting 6000 K, 2x 6,3 W, 2x 660 lumen, EEC F <b>brighness dimmable</b></i></p>	60,0	68,2	2,8	<b>SPBSA6</b>  			<b>1107</b>		
		<b>NEW</b>							
 <p>LED-Aufbauleuchte für Spiegelpanel mit LED-Mini-Stecker, 6000 K, 8,6 W, 792 Lumen, EEK E <b>Helligkeit dimmbar</b>  <i>LED-lighting for mirror panel with LED-mini-plug, 6000 K, 8,6 W, 792 lumen, EEC E <b>brighness dimmable</b></i></p>	60,0	2,4	10,0	<b>AWP60</b>  			<b>323</b>		
		<b>NEW</b>							





EEK/EEC=Energieeffizienzklasse/energy efficiency category

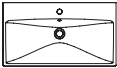

Leuchtmittel sind nicht austauschbar / illuminants are not interchangeable.



# 3020life »60 cm Keramik/ceramic«

Beschreibung Description	Maße in cm Dimensions in cm			Artikel-Nr. Article no.	Türanschlag Door stop	Identnummer ID number
	B/W	H	T/D			

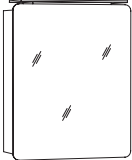
	Keramik-Waschtisch inkl. Überlauf und Befestigungsmaterial  <i>ceramic washbasin incl. overflow and mounting material</i>	60,0	5,0	44,5	<b>KWELI60</b> 	<b>530</b>
---	--	------	-----	------	---	------------

					PG1	PG2	PG3	
	Waschtisch-Unterschrank 2 Türen  <i>washbasin base cabinet 2 doors</i>	56,0	48,8	43,0	<b>WKETT5</b> 	<b>439</b>	<b>530</b>	<b>670</b>
	Waschtisch-Unterschrank 2 Auszüge  <i>washbasin base cabinet 2 extensions</i>	56,0	48,8	43,0	<b>WKEAA5</b> 	<b>830</b>	<b>900</b>	<b>1038</b>

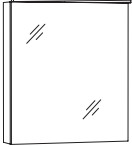
	Aufbauleuchte/top light Spiegelschrank, 1 Spiegeltür 2 Glaseinlegeböden, inkl. Schalter/ Steckdose, LED-Aufbauleuchte LL54, 6000 K, 4,3 W, 518 Lumen, EEK E  <i>mirror cabinet, 1 mirror door 2 glass boards, incl. switch/socket, LED lighting LL54, 6000 K, 4,3 W, 518 lumen, EEC E</i>	60,0	74,2	17,6	<b>SLE6L</b> <b>SLE6R</b>  ehemals FSPSR60L FSPSR60R   Dieses Produkt enthält eine Lichtquelle der Energieeffizienzklasse E	Links/left Rechts/right	<b>1079</b>
--	---	------	------	------	--	----------------------------	-------------

	Aufbauleuchte/top light Spiegelschrank, 1 Spiegeltür mit aufgeklebtem Innenspiegel, 2 Glaseinlegeböden, inkl. Schalter/ Steckdose, LED-Aufbauleuchte ASL60, 4000 K, 5,8 W, 248 Lumen, EEK F  <i>mirror cabinet, 1 mirror door with glued-on interior mirror, 2 glass boards, incl. switch/socket, LED lighting ASL60, 4000 K, 5,8 W, 248 lumen, EEC F</i>	60,0	68,2	17,6	<b>SASL6LS</b> <b>SASL6RS</b>   Dieses Produkt enthält eine Lichtquelle der Energieeffizienzklasse E	Links/left Rechts/right	<b>900</b>
---	--	------	------	------	---	----------------------------	------------



	Spiegelpaneel, Sensorschalter, seitliche LED-Beleuchtung 6000 K, 2x 6,3 W, 2x 660 Lumen, EEK F <b>Helligkeit dimmbar</b>  <i>mirror panel, sensor switch, lateral LED-lighting 6000 K, 2x 6,3 W, 2x 660 lumen, EEC F brightness dimmable</i>	60,0	68,2	2,8	<b>SPBSA6</b>    Dieses Produkt enthält eine Lichtquelle der Energieeffizienzklasse F		<b>1107</b>
---	---	------	------	-----	---	--	-------------



	LED-Aufbauleuchte für Spiegelpaneel mit LED-Mini-Stecker, 6000 K, 8,6 W, 792 Lumen, EEK E <b>Helligkeit dimmbar</b>  <i>LED-lighting for mirror panel with LED-mini-plug, 6000 K, 8,6 W, 792 lumen, EEC E brightness dimmable</i>	60,0	2,4	10,0	<b>AWP60</b>    Dieses Produkt enthält eine Lichtquelle der Energieeffizienzklasse E		<b>323</b>
---	--	------	-----	------	--	--	------------

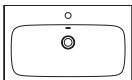

EEK/EEC=Energieeffizienzklasse/energy efficiency category  
Leuchtmittel sind nicht austauschbar / illuminants are not interchangeable.



# 3020life »80 cm Mineralmarmor/marble minerals«

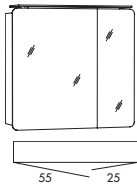

Beschreibung Description	Maße in cm Dimensions in cm			Artikel-Nr. Article no.	Türanschlag Door stop	Identnummer ID number		
	B/W	H	T/D			PG1	PG2	PG3

 <p>Mineralmarmor-Waschtisch inkl. Überlauf <i>marble minerals washbasin incl. overflow</i></p>	76,5	1,5	45,0	<b>MWIDE8</b> 	PG1 Weiß alpin/gloss alpine		PG2 Granit/granite
					1114		1394

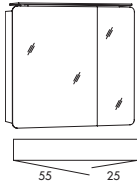
 <p>Waschtisch-Unterschrank 2 Türen <i>washbasin base cabinet 2 doors</i></p>	76,0	47,8	44,5	<b>FWUIT76</b>	PG1	PG2	PG3
					554	646	785
 <p>Waschtisch-Unterschrank 2 Auszüge <i>washbasin base cabinet 2 extensions</i></p>	76,0	47,8	44,5	<b>FWUI76</b>	1022	1106	1259

<p>Aufbauleuchte/top light</p>  <p>Spiegelschrank, 2 Spiegeltüren 2 Glaseinlegeböden, inkl. Schalter/ Steckdose, LED-Aufbauleuchte LL74, 6000 K, 6,0 W, 720 Lumen, EEK E</p> <p><i>mirror cabinet, 2 mirror doors 2 glass boards, incl. switch/socket LED lighting LL74, 6000 K, 6,0 W, 720 lumen, EEC E</i></p>	80,0	74,2	17,6	<b>SLLE8</b> ehemals FSPSR80 	1146		
					Dieses Produkt enthält eine Lichtquelle der Energieeffizienzklasse E		

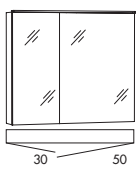
<p>Aufbauleuchte/top light</p>  <p>Spiegelschrank, 2 Spiegeltüren mit aufgeklebtem Innenspiegel, 2 Glaseinlegeböden, inkl. Schalter/ Steckdose, LED-Aufbauleuchte LL74, 6000 K, 6,0 W, 720 Lumen, EEK E</p> <p><i>mirror cabinet, 2 mirrored doors with glued-on interior mirror, 2 glass boards, incl. switch/socket, LED lighting LL74, 6000 K, 6,0 W, 720 lumen, EEC E</i></p>	80,0	74,2	17,6	<b>SLLE8S</b> ehemals FSPSR80S 	1190		
					Dieses Produkt enthält eine Lichtquelle der Energieeffizienzklasse E		

<p>Aufbauleuchte/top light</p>  <p>Spiegelschrank, 2 Spiegeltüren mit aufgeklebtem Innenspiegel, 2 Glaseinlegeböden, inkl. Schalter/ Steckdose, LED-Aufbauleuchte ASL80, 4000 K, 7,8 W, 331 Lumen, EEK F</p> <p><i>mirror cabinet, 2 mirrored doors with glued-on interior mirror, 2 glass boards, incl. switch/socket, LED lighting ASL80, 4000 K, 7,8 W, 331 lumen, EEC F</i></p>	80,0	68,2	17,6	<b>SASL8RS</b>  	1107		
					Dieses Produkt enthält eine Lichtquelle der Energieeffizienzklasse F		

EEK/EEC=Energieeffizienzklasse/energy efficiency category  
Leuchtmittel sind nicht austauschbar / illuminants are not interchangeable.



# 3020life »80 cm Mineralmarmor/marble minerals«



Beschreibung Description	Maße in cm Dimensions in cm			Artikel-Nr. Article no.	Türanschlag Door stop	Identnummer ID number
	B/W	H	T/D			



	<p>Spiegelpaneel, Sensorschalter, seitliche LED-Beleuchtung 6000 K, 2x 6,3 W, 2x 660 Lumen, EEK F <b>Helligkeit dimmbar</b></p> <p><i>mirror panel, sensor switch, lateral LED-lighting 6000 K, 2x 6,3 W, 2x 660 lumen, EEC F</i> <b>brighness dimmable</b></p>	80,0	68,2	2,8	<p><b>SPBSA8</b></p> <div style="display: flex; justify-content: space-around;"> <div style="text-align: center;"> </div> <div style="text-align: center;"> </div> </div> <p>Dieses Produkt enthält eine Lichtquelle der Energieeffizienzklasse F</p>	1154
	<p>LED-Aufbauleuchte für Spiegelpaneel mit LED-Mini-Stecker, 6000 K, 10,8 W, 1350 Lumen, EEK E <b>Helligkeit dimmbar</b></p> <p><i>LED-lighting for mirror panel with LED-mini-plug, 6000 K, 10,8 W, 1350 lumen, EEC E</i> <b>brighness dimmable</b></p>	80,0	2,4	10,0	<p><b>AWP80</b></p> <div style="display: flex; justify-content: space-around;"> <div style="text-align: center;"> </div> <div style="text-align: center;"> </div> </div> <p>Dieses Produkt enthält eine Lichtquelle der Energieeffizienzklasse E</p>	370

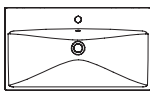

EEK/EEC=Energieeffizienzklasse/energy efficiency category  
Leuchtmittel sind nicht austauschbar / illuminants are not interchangeable.



# 3020life »80 cm Keramik/ceramic«

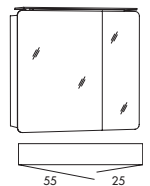

Beschreibung Description	Maße in cm Dimensions in cm			Artikel-Nr. Article no.	Türanschlag Door stop	Identnummer ID number
	B/W	H	T/D			

 <p>Keramik-Waschtisch inkl. Überlauf und Befestigungsmaterial</p> <p><i>ceramic washbasin incl. overflow and mounting material</i></p>	80,0	5,0	44,5	KWELI80		783

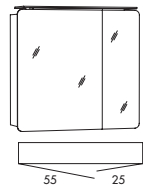
						PG1	PG2	PG3
 <p>Waschtisch-Unterschrank 2 Türen</p> <p><i>washbasin base cabinet 2 doors</i></p>	76,0	49,5	44,0	FWUKT76		534	577	670
 <p>Waschtisch-Unterschrank 2 Auszüge</p> <p><i>washbasin base cabinet 2 extensions</i></p>	76,0	49,5	44,0	FWUK76		877	946	1016

<p>Aufbauleuchte/top light</p>  <p>Spiegelschrank, 2 Spiegeltüren 2 Glaseinlegeböden, inkl. Schalter/ Steckdose, LED-Aufbauleuchte LL74, 6000 K, 6,0 W, 720 Lumen, EEK E</p> <p><i>mirror cabinet, 2 mirror doors 2 glass boards, incl. switch/socket LED lighting LL74, 6000 K, 6,0 W, 720 lumen, EEC E</i></p>	80,0	74,2	17,6	SLLE8	 <p>ehemals FSPSR80</p> <p>Dieses Produkt enthält eine Lichtquelle der Energieeffizienzklasse E</p>	1146

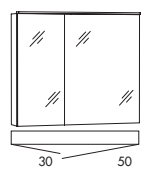
<p>Aufbauleuchte/top light</p>  <p>Spiegelschrank, 2 Spiegeltüren mit aufgeklebtem Innenspiegel, 2 Glaseinlegeböden, inkl. Schalter/ Steckdose, LED-Aufbauleuchte LL74, 6000 K, 6,0 W, 720 Lumen, EEK E</p> <p><i>mirror cabinet, 2 mirrored doors with glued-on interior mirror, 2 glass boards, incl. switch/socket, LED lighting LL74, 6000 K, 6,0 W, 720 lumen, EEC E</i></p>	80,0	74,2	17,6	SLLE8S	 <p>ehemals FSPSR80S</p> <p>Dieses Produkt enthält eine Lichtquelle der Energieeffizienzklasse E</p>	1190

<p>Aufbauleuchte/top light</p>  <p>Spiegelschrank, 2 Spiegeltüren mit aufgeklebtem Innenspiegel, 2 Glaseinlegeböden, inkl. Schalter/ Steckdose, LED-Aufbauleuchte ASL80, 4000 K, 7,8 W, 331 Lumen, EEK F</p> <p><i>mirror cabinet, 2 mirrored doors with glued-on interior mirror, 2 glass boards, incl. switch/socket, LED lighting ASL80, 4000 K, 7,8 W, 331 lumen, EEC F</i></p>	80,0	68,2	17,6	SASL8RS	 <p>Dieses Produkt enthält eine Lichtquelle der Energieeffizienzklasse F</p>	1107











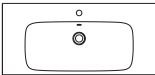

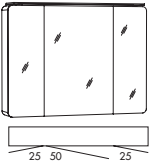

EEK/EEC=Energieeffizienzklasse/energy efficiency category  
Leuchtmittel sind nicht austauschbar / illuminants are not interchangeable.

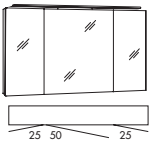
# 3020life »80 cm Keramik/ceramic«

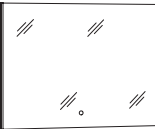
Beschreibung Description	Maße in cm Dimensions in cm			Artikel-Nr. Article no.	Türanschlag Door stop	Identnummer ID number
	B/W	H	T/D			

	<p>Spiegelpaneel, Sensorschalter, seitliche LED-Beleuchtung 6000 K, 2x 6,3 W, 2x 660 Lumen, EEK F <b>Helligkeit dimmbar</b></p> <p><i>mirror panel, sensor switch, lateral LED-lighting 6000 K, 2x 6,3 W, 2x 660 lumen, EEC F</i> <b>brighness dimmable</b></p>	80,0	68,2	2,8	<p><b>SPBSA8</b></p> <div style="display: flex; justify-content: space-around;"> <div style="text-align: center;"> </div> <div style="text-align: center;"> </div> </div> <p>Dieses Produkt enthält eine Lichtquelle der Energieeffizienzklasse F</p>	1154
	<p>LED-Aufbauleuchte für Spiegelpaneel mit LED-Mini-Stecker, 6000 K, 10,8 W, 1350 Lumen, EEK E <b>Helligkeit dimmbar</b></p> <p><i>LED-lighting for mirror panel with LED-mini-plug, 6000 K, 10,8 W, 1350 lumen, EEC E</i> <b>brighness dimmable</b></p>	80,0	2,4	10,0	<p><b>AWP80</b></p> <div style="display: flex; justify-content: space-around;"> <div style="text-align: center;"> </div> <div style="text-align: center;"> </div> </div> <p>Dieses Produkt enthält eine Lichtquelle der Energieeffizienzklasse E</p>	370



EEK/EEC=Energieeffizienzklasse/energy efficiency category  
Leuchtmittel sind nicht austauschbar / illuminants are not interchangeable.



Beschreibung Description	Maße in cm Dimensions in cm			Artikel-Nr. Article no.	Türanschlag Door stop	Identnummer ID number		
	B/W	H	T/D			PG1 Weiß alpin/gloss alpine	PG2 Granit/granite	
 <p>Mineralmarmor-Waschtisch inkl. Überlauf <i>marble minerals washbasin incl. overflow</i></p>	96,5	1,5	45,0	<b>MWIDE10</b> 			<b>1277</b>	<b>1598</b>
 <p>Waschtisch-Unterschrank 2 Türen <i>washbasin base cabinet 2 doors</i></p>	96,0	47,8	44,5	<b>FWUIT96</b>			<b>646</b>	<b>739</b> <b>877</b>
 <p>Waschtisch-Unterschrank 2 Auszüge <i>washbasin base cabinet 2 extensions</i></p>	96,0	47,8	44,5	<b>FWUI96</b>			<b>1163</b>	<b>1254</b> <b>1405</b>
<p><b>Aufbauleuchte/top light</b></p>  <p>Spiegelschrank, 3 Spiegeltüren 6 Glaseinlegeböden, inkl. Schalter/ Steckdose, LED-Aufbauleuchte LL94, 6000 K, 7,4 W, 892 Lumen, EEK E <i>mirror cabinet, 3 mirror doors 6 glass boards, incl. switch/socket LED lighting LL94, 6000 K, 7,4 W, 892 lumen, EEC E</i></p>	100,0	74,2	17,6	<b>SLE10</b> ehemals FSPSR100 			<b>1535</b>	
<p><b>Aufbauleuchte/top light</b></p>  <p>Spiegelschrank, 3 Spiegeltüren 6 Glaseinlegeböden, inkl. Schalter/ Steckdose, LED-Aufbauleuchte ASL80, 4000 K, 7,8 W, 331 Lumen, EEK F <i>mirror cabinet, 3 mirror doors 6 glass shelves, incl. switch/socket LED lighting ASL80, 4000 K, 7,8 W, 331 lumen, EEC F</i></p>	100,0	68,2	17,6	<b>SASL10</b> 	<b>NEW</b>		<b>1315</b>	
 <p>Spiegelpanel, Sensorschalter, seitliche LED-Beleuchtung 6000 K, 2x 6,3 W, 2x 660 Lumen, EEK F <b>Helligkeit dimmbar</b> <i>mirror panel, sensor switch, lateral LED-lighting 6000 K, 2x 6,3 W, 2x 660 lumen, EEC F brightness dimmable</i></p>	100,0	68,2	2,8	<b>SPBSA10</b>  	<b>NEW</b>		<b>1246</b>	
 <p>LED-Aufbauleuchte für Spiegelpanel mit LED-Mini-Stecker, 6000 K, 13,7 W, 1440 Lumen, EEK F <b>Helligkeit dimmbar</b> <i>LED-lighting for mirror panel with LED-mini-plug, 6000 K, 13,7 W, 1440 lumen, EEC F brightness dimmable</i></p>	100,0	2,4	10,0	<b>AWP100</b>  	<b>NEW</b>		<b>415</b>	

EEK/EEC=Energieeffizienzklasse/energy efficiency category

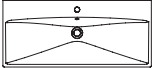
Leuchtmittel sind nicht austauschbar / illuminants are not interchangeable.

Beschreibung Description	Maße in cm Dimensions in cm			Artikel-Nr. Article no.	Türanschlag Door stop	Identnummer ID number
	B/W	H	T/D			

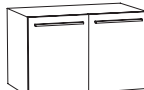
	Keramik-Waschtisch inkl. Überlauf und Befestigungsmaterial  <i>ceramic washbasin incl. overflow and mounting material</i>	100,0	5,0	45,0	<b>KWEL100</b> 	<b>880</b>
---	--	-------	-----	------	---	------------

						PG1	PG2	PG3
	Waschtisch-Unterschrank 2 Türen  <i>washbasin base cabinet 2 doors</i>	96,0	49,5	44,0	<b>FWUKT96</b>	<b>577</b>	<b>692</b>	<b>785</b>
	Waschtisch-Unterschrank 2 Auszüge  <i>washbasin base cabinet 2 extensions</i>	96,0	49,5	44,0	<b>FWUK96</b>	<b>946</b>	<b>1061</b>	<b>1154</b>

<b>Aufbauleuchte/top light</b>	Spiegelschrank, 3 Spiegeltüren 6 Glaseinlegeböden, inkl. Schalter/ Steckdose, LED-Aufbauleuchte LL94, 6000 K, 7,4 W, 892 Lumen, EEK E  <i>mirror cabinet, 3 mirror doors 6 glass boards, incl. switch/socket LED lighting LL94, 6000 K, 7,4 W, 892 lumen, EEC E</i>	100,0	74,2	17,6	<b>SLE10</b>  ehemals FSPSR100   Dieses Produkt enthält eine Lichtquelle der Energieeffizienzklasse E	<b>1535</b>
--------------------------------	--	-------	------	------	--	-------------









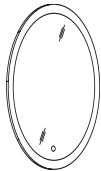

<b>Aufbauleuchte/top light</b>	Spiegelschrank, 3 Spiegeltüren 6 Glaseinlegeböden, inkl. Schalter/ Steckdose, LED-Aufbauleuchte ASL80, 4000 K, 7,8 W, 331 Lumen, EEK F  <i>mirror cabinet, 3 mirror doors 6 glass shelves, incl. switch/socket LED lighting ASL80, 4000 K, 7,8 W 331 lumen, EEC F</i>	100,0	68,2	17,6	<b>SASL10</b>   Dieses Produkt enthält eine Lichtquelle der Energieeffizienzklasse F	<b>1315</b>
--------------------------------	--	-------	------	------	--	-------------

	Spiegelpaneel, Sensorschalter, seitliche LED-Beleuchtung 6000 K, 2x 6,3 W, 2x 660 Lumen, EEK F <b>Helligkeit dimmbar</b>  <i>mirror panel, sensor switch, lateral LED-lighting 6000 K, 2x 6,3 W, 2x 660 lumen, EEC F <b>brighness dimmable</b></i>	100,0	68,2	2,8	<b>SPBSA10</b>    Dieses Produkt enthält eine Lichtquelle der Energieeffizienzklasse F	<b>1246</b>
---	---	-------	------	-----	--	-------------

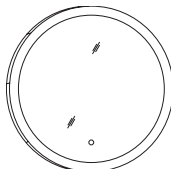
	LED-Aufbauleuchte für Spiegelpaneel mit LED-Mini-Stecker, 6000 K, 13,7 W, 1440 Lumen, EEK F <b>Helligkeit dimmbar</b>  <i>LED-lighting for mirror panel with LED-mini-plug, 6000 K, 13,7 W, 1440 lumen, EEC F <b>brighness dimmable</b></i>	100,0	2,4	10,0	<b>AWP100</b>    Dieses Produkt enthält eine Lichtquelle der Energieeffizienzklasse F	<b>415</b>
---	--	-------	-----	------	---	------------

EEK/EEC=Energieeffizienzklasse/energy efficiency category  
Leuchtmittel sind nicht austauschbar / illuminants are not interchangeable.

# 3020life »Spiegelpaneele und Zubehör/ mirror panels and accessoires«

Beschreibung Description	Maße in cm Dimensions in cm			Artikel-Nr. Article no.	Türanschlag Door stop	Identnummer ID number
	B/W	H	T/D			
 <p>Spiegelpaneel, Sensorschalter, satiniert, LED Beleuchtung, 4000 K, 17,3 W, 2415 Lumen, EEK G <b>Helligkeit dimmbar</b></p> <p><i>mirror panel, sensor switch, satined, LED-lighting, 4000 K, 17,3 W, 2415 lumen, EEC G</i> <b>brighness dimmable</b></p>	55,0	78,0	2,8	<b>SPE55</b>	  <p>Dieses Produkt enthält eine Lichtquelle der Energieeffizienzklasse G</p>	1131
 <p>Spiegelpaneel, Sensorschalter, satiniert, LED Beleuchtung, 4000 K, 13,5 W, 1890 Lumen, EEK G <b>Helligkeit dimmbar</b></p> <p><i>mirror panel, sensor switch, satined, LED-lighting, 4000 K, 13,5 W, 1890 lumen, EEC G</i> <b>brighness dimmable</b></p>	55,0	55,0	2,8	<b>SPK55</b>	  <p>Dieses Produkt enthält eine Lichtquelle der Energieeffizienzklasse G</p>	992
 <p>Spiegelpaneel, Sensorschalter, satiniert, LED Beleuchtung, 4000 K, 20,8 W, 2905 Lumen, EEK G <b>Helligkeit dimmbar</b></p> <p><i>mirror panel, sensor switch, satined, LED-lighting, 4000 K, 20,8 W, 2905 lumen, EEC G</i> <b>brighness dimmable</b></p>	78,0	78,0	2,8	<b>SPK78</b>	  <p>Dieses Produkt enthält eine Lichtquelle der Energieeffizienzklasse G</p>	1292
 <p>Schubkasteneinsatz (Kunststoff) für oberen Auszug vom WT-Unterschrank</p> <p><i>drawer insert part (plastic) for top drawer from base cabinet</i></p>	33,7	4,3	33,0	<b>SMBEG3</b>		69
 <p>Sockelfuß 4 x 4 cm silbergrau, Höhenausgleich bis 2 cm je 2 Stück/Pack</p> <p><i>base foot 4 x 4 cm silver-grey, height adjustment up to 2 cm, 2 pieces/pack</i></p>	4,0	12,0/ 14,0	4,0	<b>SPE12</b>		139
 <p>Steckdose/Powerbox für Spiegelschränke Ausführung <b>Schweiz</b> IP44 mit USB-C Stecker</p> <p><i>Power socket for mirror cabinets Switzerland type IP44 with USB-C plug</i></p>					<b>Mehrpreis extra charge</b>	138
 <p>Steckdose/Powerbox für Spiegelschränke Ausführung <b>Frankreich</b> mit USB-C Stecker</p> <p><i>Power socket for mirror cabinets France type with USB-C plug</i></p>					<b>Mehrpreis extra charge</b>	138

EEK/EEC=Energieeffizienzklasse/energy efficiency category  
Leuchtmittel sind nicht austauschbar / illuminants are not interchangeable.

**i** Weiteres Zubehör finden Sie im Register 3970 und Beistellschränke im Register 3990.  
**Further accessoires can be found in register 3970 and side cabinets in register 3990.**



# 3040city

3040

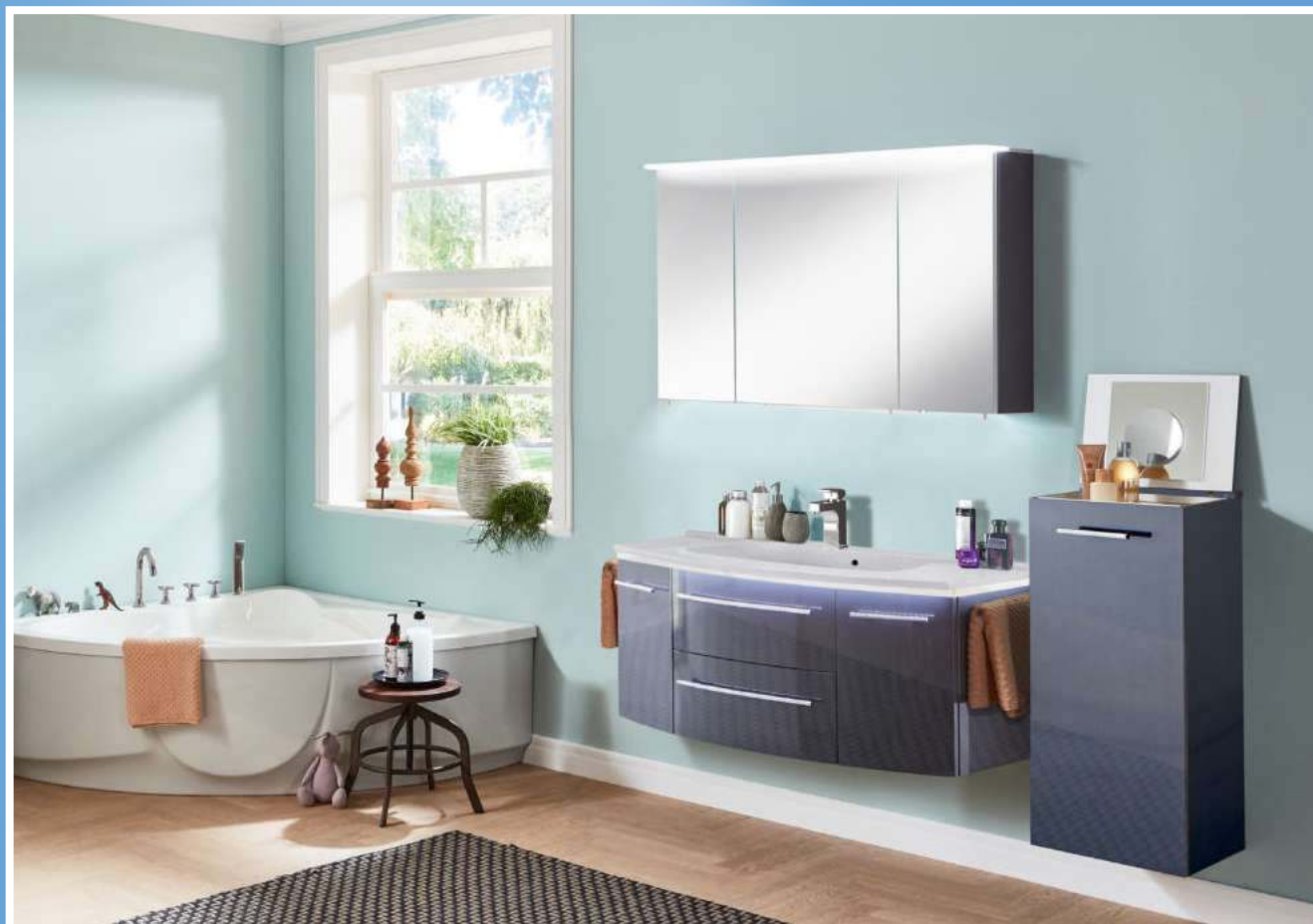





## Piktogramme/pictograms



Mineralmarmor Waschtisch  
Marble minerals washbasin



LED Lichtfarbe kalt  
LED colour temperature cold



LED mit Bewegungssensor  
LED with motion sensor



Keramik Waschtisch  
Ceramic washbasin

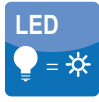

LED Lichtfarbe warm  
LED colour temperature warm



LED mit Sensorschalter,  
Helligkeit dimmbar  
LED with sensor switch,  
brightness dimmable



Glas Waschtisch  
Glass washbasin

## Gerundeter Mineralmarmor Waschtisch Glanz Rounded gloss marble minerals washbasin

≈ Beckenmaße in cm (BxHxT)  
basin dimensions in cm (WxHxD)

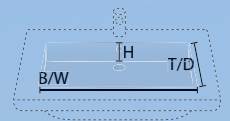

CITY60 | 48,5x12x24,2 cm



CITY90 | 75,3x12x27,8 cm



Detail



CITY120 | 75,3x12x27,8 cm

### Dekorband für Mineralmarmor-Waschtisch decorative strip for marble minerals washbasin



Standard  
silber / silver



OPTIONAL  
LED-Band/LED stripe  
WLED60/90/120R



OPTIONAL  
STRASS-Dekorband/rhinestone decor stripe  
WSTR

### Mineralmarmor Glanz/gloss marble minerals PG1



Weiß Alpin Glanz  
Gloss Alpine White  
CP69

Bei granitfarbigen Waschtischen kann es zu Farbabweichungen kommen, da der Gelcoat die Farbgebung maßgeblich beeinflusst und sich im Laufe der Zeit die Farbe durch Lichteinflüsse (Sonneneinstrahlung) verändern kann.  
Colour deviations may occur with granite-coloured washbasins and the colour may change over time due to the influence of direct sunlight.

### PG2



Granit Weiß Glimmer  
White Granite Glimmer  
CP74

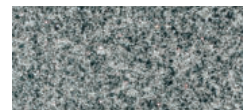

Granit Grau Glimmer  
Grey Granite Glimmer  
CP73

# »3040city«

## Keramik-Waschtisch weiß Glanz (CP00)

### Ceramic washbasin gloss white (CP00)

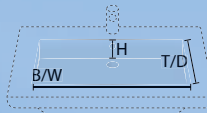
 ≈ Beckenmaße in cm (BxHxT)  
basin dimensions in cm (WxHxD)



#### LED-Band für Keramik-Waschtisch LED stripe for ceramic washbasin



! Diese Keramikwaschtische benötigen keine Wandbefestigung.  
These ceramic basins do not require wall mounting.

## Glas-Waschtisch weiß Glanz (CP79)

### Glas washbasin gloss white (CP79)



## Glas-Waschtisch anthrazit Matt (CP80)

### Glas washbasin matt anthracite (CP80)



# »3040city« Farb-Varianten/colour options

## Schränke/cabinets 3040city

### Frontfarben/front colours

MDF-foliiert/MDF coated

449



**Kastanie Graphit Nachbildung**  
*Graphite Chestnut Finish*  
CPC\_

952



**Rot Glanz**  
*Gloss Red*  
CPR\_

273



**Eiche Struktur Natur Nachbildung**  
*Oak Structure Nature Finish*  
CPM\_

961



**Weiß Glanz**  
*Gloss White*  
CPW\_

235



**Eiche Struktur Weiß Nachbildung** NEW  
*Oak Structure White Finish*  
CPL\_

438



**Anthrazit Glanz**  
*Gloss Anthracite*  
CPF\_

226



**Eiche Struktur Braun Nachbildung** NEW  
*Oak Structure Brown Finish*  
CPH\_

### Korpusfarben/basic shell colours

PG 2 Dickkante/thick edge

490



**Kastanie Graphit Nachbildung**  
*Graphite Chestnut Finish*  
C/CP45

426



**Eiche Struktur Braun Nachbildung** NEW  
*Oak Structure Brown Finish*  
H/CP70

473



**Eiche Struktur Natur Nachbildung**  
*Oak Structure Nature Finish*  
M/CP55

030

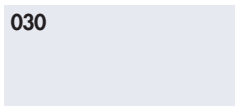

**Weiß Matt**  
*Matt White*  
W/CP90

435



**Eiche Struktur Weiß Nachbildung** NEW  
*Oak Structure White Finish*  
L/CP40

PG 3 MDF-foliiert/MDF-coated

042



**Weiß Glanz Folie**  
*Gloss White*  
G/CP50

438



**Anthrazit Glanz Folie**  
*Gloss Anthracite*  
F/CP30

## Griffe/handles



**Chrom Glanz**  
Gloss chrome  
Griffnummer/handle number: 193/183  
⌀-⌀ 96 mm/128 mm



**Chrom Glanz**  
Gloss chrome  
Griffnummer/handle number: 182/187/620  
⌀-⌀ 384 mm/460 mm/387-387 mm

⌀-⌀ = Bohrabstand/hole spacing

Die Angabe einer Griffnummer ist ausreichend. Die Griffe werden passend zur jeweiligen Schrankbreite beigelegt.  
The indication of one handle number is sufficient. The handles are supplied to match the respective cabinet width.

## Beleuchtung / lighting

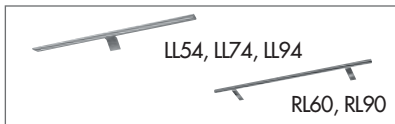

**Aufbauleuchte LED**  
Top light LED



**Acryloberboden LED**  
Acrylic top LED



**Seitlich und oben LED Beleuchtung**  
lateral and top LED lighting



**Aufbauleuchte LED**  
Top light LED

**Lichtfarbe Tageslicht (Kalt)**  
Luminous colour natural light (cold)













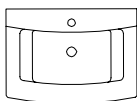

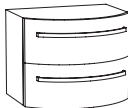
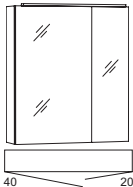

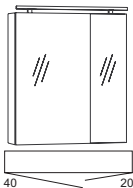
LL54, LL74, LL94,  
RL60, RL90

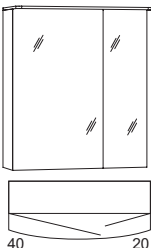

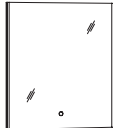
AWP60,  
AWP90,  
AWP120

Die Steckdose / Powerbox für Spiegelschränke ist auch in Ausführung für die Schweiz / Frankreich erhältlich. Bitte Mehrpreis beachten (siehe Seite 19).  
The power socket for mirror cabinets is also available for Switzerland / France. Please note extra charge (see page 19).









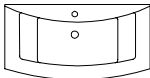

# 3040city »60 cm Mineralmarmor/marble minerals«

Beschreibung Description	Maße in cm Dimensions in cm			Artikel-Nr. Article no.	Türanschlag Door stop	Identnummer ID number	
	B/W	H	T/D			PG1 Weiß alpin/gloss alpine	PG2 Granit/granite
 <p>Mineralmarmor-Waschtisch inkl. Überlauf</p> <p><i>marble minerals washbasin incl. overflow</i></p>	60,8	4,0	41,0/ 44,0	<b>CITYR60</b> 		<b>739</b>	<b>1016</b>
 <p>Waschtisch-Unterschrank 2 Auszüge</p> <p><i>washbasin base cabinet 2 extensions</i></p>	60,0	47,8	40,0/ 43,0	<b>WMCAAR6</b> ehemals CUAR62D-4		<b>1684</b>	<b>2030</b>
<p><b>Aufbauleuchte/top light</b></p>  <p>Spiegelschrank, 2 Spiegeltüren mit aufgeklebtem Innenspiegel, 2 Glaseinlegeböden, inkl. Schalter/ Steckdose, LED-Aufbauleuchte LL54, 6000 K, 4,3 W, 518 Lumen, EEK E</p> <p><i>mirror cabinet, 2 mirrored doors with glued-on interior mirror, 2 glass shelves, incl. switch/socket, LED lighting LL54, 6000 K, 4,3 W, 518 lumen, EEC E</i></p>	60,0	68,2	17,6	<b>SLLB6</b> 			<b>992</b>
<p><b>Aufbauleuchte/top light</b></p>  <p>Spiegelschrank, 2 Spiegeltüren mit aufgeklebtem Innenspiegel, 2 Glaseinlegeböden, inkl. Schalter/ Steckdose, LED-Aufbauleuchte RL60, 6000 K, 4,8 W, 576 Lumen, EEK E</p> <p><i>mirror cabinet, 2 mirrored doors with glued-on interior mirror, 2 glass shelves, incl. switch/socket, LED lighting RL60, 6000 K, 4,8 W, 576 lumen, EEC E</i></p>	60,0	68,2	17,6	<b>SPSE600D-4</b> 			<b>1200</b>
<p><b>Acryloberboden/acryl top</b></p>  <p>Spiegelschrank, 2 Spiegeltüren mit aufgeklebtem Innenspiegel, 2 Glaseinlegeböden, inkl. Schalter/Steckdose, <b>gerundeter Acryloberboden</b> mit LED-Beleuchtung, 6000 K, 7,0 W, 540 Lumen, EEK G</p> <p><i>mirror cabinet, 2 mirrored doors with glued-on interior mirror, 2 glass shelves, incl. switch/socket, <b>rounded acryl-top</b> with LED lighting, 6000 K, 7,0 W, 540 lumen, EEC G</i></p>	60,0	68,2	17,6	<b>SAOE6</b> 	<b>NEW</b>		<b>1154</b>
 <p>Spiegelpaneel, Sensorschalter, seitliche LED-Beleuchtung 6000 K, 2x 6,3 W, 2x 660 Lumen, EEK F <b>Helligkeit dimmbar</b></p> <p><i>mirror panel, sensor switch, lateral LED-lighting 6000 K, 2x 6,3 W, 2x 660 lumen, EEC F <b>brighness dimmable</b></i></p>	60,0	68,2	2,8	<b>SPBSA6</b>  	<b>NEW</b>		<b>1107</b>
 <p>LED-Aufbauleuchte für Spiegelpaneel mit LED-Mini-Stecker, 6000 K, 8,6 W, 792 Lumen, EEK E <b>Helligkeit dimmbar</b></p> <p><i>LED-lighting for mirror panel with LED-mini-plug, 6000 K, 8,6 W, 792 lumen, EEC E <b>brighness dimmable</b></i></p>	60,0	2,4	10,0	<b>AWP60</b>  	<b>NEW</b>		<b>323</b>

EEK/EEC=Energieeffizienzklasse/energy efficiency category.

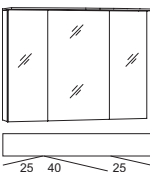

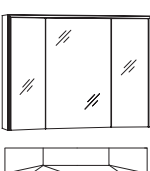



Leuchtmittel sind nicht austauschbar / illuminants are not interchangeable.

# 3040city »90 cm Mineralmarmor/marble minerals«

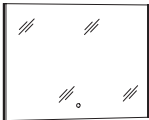
Beschreibung Description	Maße in cm Dimensions in cm			Artikel-Nr. Article no.	Türanschlag Door stop	Identnummer ID number	
	B/W	H	T/D			PG1	PG2
 <p>Mineralmarmor-Waschtisch inkl. Überlauf</p> <p><i>marble minerals washbasin incl. overflow</i></p>	92,4	4,0	41,0/ 48,0	<b>CITY90</b> 		PG1 Weiß alpin/gloss alpine <b>761</b>	PG2 Granit/granite <b>1246</b>
 <p>Waschtisch-Unterschrank 2 Auszüge</p> <p><i>washbasin base cabinet 2 extensions</i></p>	90,0	47,8	40,0/ 47,0	<b>WMCAAR9</b> ehemals CUAR92D-4		PG2 <b>1846</b>	PG3 <b>2123</b>
<p><b>Aufbauleuchte/top light</b></p>  <p>Spiegelschrank, 3 Spiegeltüren, 6 Glaseinlegeböden, inkl. Schalter/ Steckdose, LED-Aufbauleuchte LL74, 6000 K, 6,0 W, 720 Lumen, EEK E</p> <p><i>mirror cabinet, 3 mirror doors, 6 glass shelves, incl. switch/socket, LED lighting LL74, 6000 K, 6,0 W 720 lumen, EEC E</i></p>	90,0	68,2	17,6	<b>SLLB9</b> 		<b>1223</b>	
<p><b>Aufbauleuchte/top light</b></p>  <p>Spiegelschrank, 3 Spiegeltüren, 6 Glaseinlegeböden, inkl. Schalter/ Steckdose, LED-Aufbauleuchte RL60, 6000 K, 4,8 W, 576 Lumen, EEK E</p> <p><i>mirror cabinet, 3 mirror doors, 6 glass shelves, incl. switch/socket, LED lighting RL60, 6000 K, 4,8 W 576 lumen, EEC E</i></p>	90,0	68,2	17,6	<b>SPSE900D-4</b> 		<b>1407</b>	
<p><b>Acryloberboden/acryl top</b></p>  <p>Spiegelschrank, 3 Spiegeltüren, 6 Glaseinlegeböden, inkl. Schalter/ Steckdose, <b>gerundeter Acryloberboden</b> mit LED-Beleuchtung, 6000 K, 8,5 W 876 Lumen, EEK E</p> <p><i>mirror cabinet, 3 mirror doors 6 glass shelves, incl. switch/socket, <b>rounded acryl-top with LED lighting,</b> 6000 K, 8,5 W, 876 lumen, EEC E</i></p>	90,0	68,2	17,6	<b>SAOE9</b> 		<b>1453</b>	
 <p>Spiegelschrank, 3 Spiegeltüren - davon 2 trapezförmig angeordnet, 6 Glasein- legeböden, inkl. Schalter/Steckdose, <b>seitlich und oben LED-Beleuchtung,</b> 6000 K, 17,9 W, 960 Lumen, EEK E</p> <p><i>mirror cabinet, 3 mirror doors - 2 of them are arranged in a trapeze, 6 glass shelves, incl. switch/socket, <b>lateral and top LED lighting,</b> 6000 K, 17,9 W, 960 lumen, EEC E</i></p>	90,0	68,2	17,6	<b>SDU9</b> 		<b>2238</b>	

EEK/EEC=Energieeffizienzklasse/energy efficiency category.  
Leuchtmittel sind nicht austauschbar / illuminants are not interchangeable.



# 3040city »90 cm Mineralmarmor/marble minerals«

Beschreibung Description	Maße in cm Dimensions in cm			Artikel-Nr. Article no.	Türanschlag Door stop	Identnummer ID number
	B/W	H	T/D			
 <p>Spiegelpaneel, Sensorschalter, seitliche LED-Beleuchtung 6000 K, 2x 6,3 W, 2x 660 Lumen, EEK F <b>Helligkeit dimmbar</b></p> <p><i>mirror panel, sensor switch, lateral LED-lighting 6000 K, 2x 6,3 W, 2x 660 lumen, EEC F</i> <b>brighthness dimmable</b></p>	90,0	68,2	2,8	<b>SPBSA9</b>	  <p>Dieses Produkt enthält eine Lichtquelle der Energieeffizienzklasse F</p>	<b>1200</b>
 <p>LED-Aufbauleuchte für Spiegelpaneel mit LED-Mini-Stecker, 6000 K, 12,5 W, 1566 Lumen, EEK E <b>Helligkeit dimmbar</b></p> <p><i>LED-lighting for mirror panel with LED-mini-plug, 6000 K, 12,5 W, 1566 lumen, EEC E</i> <b>brighthness dimmable</b></p>	90,0	2,4	10,0	<b>AWP90</b>	  <p>Dieses Produkt enthält eine Lichtquelle der Energieeffizienzklasse E</p>	<b>392</b>

EEK/EEC=Energieeffizienzklasse/energy efficiency category.  
Leuchtmittel sind nicht austauschbar / illuminants are not interchangeable.

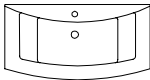

# 3040city »90 cm Keramik/ceramic«



Beschreibung Description	Maße in cm Dimensions in cm			Artikel-Nr. Article no.	Türanschlag Door stop	Identnummer ID number
	B/W	H	T/D			

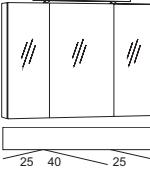

 <p>Keramik-Waschtisch inkl. Überlauf</p> <p>ceramic washbasin incl. overflow</p>	91,0	2,0	45,0/ 51,0	CITYKD90		1384
						PG2

 <p>Waschtisch-Unterschrank 2 Auszüge</p> <p>washbasin base cabinet 2 extensions</p>	90,0	47,8	38,0/ 47,0	WKBA09	1892	2168
					PG2	PG3

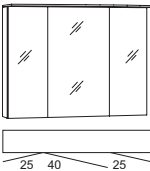
<p>Aufbauleuchte/top light</p>  <p>Spiegelschrank, 3 Spiegeltüren, 6 Glaseinlegeböden, inkl. Schalter/ Steckdose, LED-Aufbauleuchte LL74, 6000 K, 6,0 W, 720 Lumen, EEK E</p> <p>mirror cabinet, 3 mirror doors, 6 glass shelves, incl. switch/socket, LED lighting LL74, 6000 K, 6,0 W 720 lumen, EEC E</p>	90,0	68,2	17,6	SLLB9		1223
						Dieses Produkt enthält eine Lichtquelle der Energieeffizienzklasse E

<p>Aufbauleuchte/top light</p>  <p>Spiegelschrank, 3 Spiegeltüren, 6 Glaseinlegeböden, inkl. Schalter/ Steckdose, LED-Aufbauleuchte RL60, 6000 K, 4,8 W, 576 Lumen, EEK E</p> <p>mirror cabinet, 3 mirror doors, 6 glass shelves, incl. switch/socket, LED lighting RL60, 6000 K, 4,8 W 576 lumen, EEC E</p>	90,0	68,2	17,6	SPSE900D-4		1407
						Dieses Produkt enthält eine Lichtquelle der Energieeffizienzklasse E

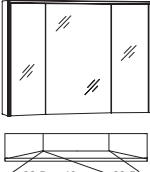
<p>Acryloberboden/acryl top</p>  <p>Spiegelschrank, 3 Spiegeltüren, 6 Glaseinlegeböden, inkl. Schalter/ Steckdose, gerundeter Acryl-oberboden mit LED-Beleuchtung, 6000 K, 8,5 W 876 Lumen, EEK E</p> <p>mirror cabinet, 3 mirror doors 6 glass shelves, incl. switch/socket, <b>rounded acryl-top</b> with LED lighting, 6000 K, 8,5 W, 876 lumen, EEC E</p>	90,0	68,2	17,6	SAOE9		1453
						Dieses Produkt enthält eine Lichtquelle der Energieeffizienzklasse E







 <p>Spiegelschrank, 3 Spiegeltüren - davon 2 trapezförmig angeordnet, 6 Glasein- legeböden, inkl. Schalter/Steckdose, <b>seitlich und oben LED-Beleuchtung</b>, 6000 K, 17,9 W, 960 Lumen, EEK E</p> <p>mirror cabinet, 3 mirror doors - 2 of them are arranged in a trapeze, 6 glass shelves, incl. switch/socket, <b>lateral and top LED lighting</b>, 6000 K, 17,9 W, 960 lumen, EEC E</p>	90,0	68,2	17,6	SDU9		2238
						Dieses Produkt enthält eine Lichtquelle der Energieeffizienzklasse E

EEK/EEC=Energyeffizienzklasse/energy efficiency category.

Leuchtmittel sind nicht austauschbar / illuminants are not interchangeable.







# 3040city »90 cm Keramik/ceramic«

Beschreibung Description	Maße in cm Dimensions in cm			Artikel-Nr. Article no.	Türanschlag Door stop	Identnummer ID number
	B/W	H	T/D			
 <p>Spiegelpaneel, Sensorschalter, seitliche LED-Beleuchtung 6000 K, 2x 6,3 W, 2x 660 Lumen, EEK F <b>Helligkeit dimmbar</b></p> <p><i>mirror panel, sensor switch, lateral LED-lighting 6000 K, 2x 6,3 W, 2x 660 lumen, EEC F</i> <b>brighthness dimmable</b></p>	90,0	68,2	2,8	<b>SPBSA9</b>	  <p>Dieses Produkt enthält eine Lichtquelle der Energieeffizienzklasse F</p>	<b>1200</b>
 <p>LED-Aufbauleuchte für Spiegelpaneel mit LED-Mini-Stecker, 6000 K, 12,5 W, 1566 Lumen, EEK E <b>Helligkeit dimmbar</b></p> <p><i>LED-lighting for mirror panel with LED-mini-plug, 6000 K, 12,5 W, 1566 lumen, EEC E</i> <b>brighthness dimmable</b></p>	90,0	2,4	10,0	<b>AWP90</b>	  <p>Dieses Produkt enthält eine Lichtquelle der Energieeffizienzklasse E</p>	<b>392</b>

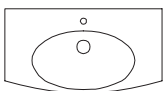

EEK/EEC=Energieeffizienzklasse/energy efficiency category.  
Leuchtmittel sind nicht austauschbar / illuminants are not interchangeable.

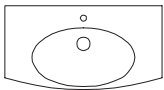

# 3040city »90 cm Glas/Glass«

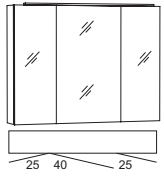

Beschreibung Description	Maße in cm Dimensions in cm			Artikel-Nr. Article no.	Türanschlag Door stop	Identnummer ID number
	B/W	H	T/D			

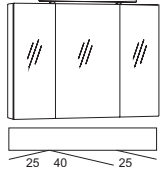

	Glas-Waschtisch <b>Weiß Glanz</b> inkl. <b>Überlauf</b>  <i>glas washbasin <b>gloss white</b> incl. <b>overflow</b></i>	90,4	1,2	47,9	<b>GWESTR9</b> 	<b>1868</b> Weiß Glanz/ <i>gloss white</i>
	Glas-Waschtisch <b>Anthrazit Matt</b> inkl. <b>Clou-Überlaufsystem</b>  <i>glas washbasin <b>matt anthracite</b> incl. <b>Clou overflow system</b></i>	90,4	1,2	47,9	<b>GWESTR9C</b> 	<b>2353</b> Anthrazit Matt/ <i>matt anthracite</i>

						PG2	PG3
	Waschtisch-Unterschrank 2 Auszüge  <i>washbasin base cabinet 2 extensions</i>	90,0	47,8	38,0/ 47,0	<b>WKBAA9</b>  ehemals WMEAA9	<b>1892</b>	<b>2168</b>

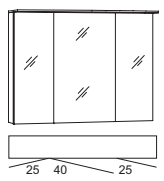
	<b>Aufbauleuchte/top light</b> Spiegelschrank, 3 Spiegeltüren, 6 Glaseinlegeböden, inkl. Schalter/ Steckdose, LED-Aufbauleuchte LL74, 6000 K, 6,0 W, 720 Lumen, EEK E  <i>mirror cabinet, 3 mirror doors, 6 glass shelves, incl. switch/socket, LED lighting LL74, 6000 K, 6,0 W 720 lumen, EEC E</i>	90,0	68,2	17,6	<b>SLLB9</b>   Dieses Produkt enthält eine Lichtquelle der Energieeffizienzklasse E	<b>1223</b>
---	---	------	------	------	--	-------------



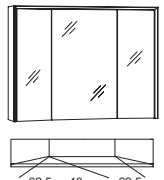



	<b>Aufbauleuchte/top light</b> Spiegelschrank, 3 Spiegeltüren, 6 Glaseinlegeböden, inkl. Schalter/ Steckdose, LED-Aufbauleuchte RL60, 6000 K, 4,8 W, 576 Lumen, EEK E  <i>mirror cabinet, 3 mirror doors, 6 glass shelves, incl. switch/socket, LED lighting RL60, 6000 K, 4,8 W 576 lumen, EEC E</i>	90,0	68,2	17,6	<b>SPSE900D-4</b>   Dieses Produkt enthält eine Lichtquelle der Energieeffizienzklasse E	<b>1407</b>
--	---	------	------	------	--	-------------

	<b>Acryloberboden/acryl top</b> Spiegelschrank, 3 Spiegeltüren, 6 Glaseinlegeböden, inkl. Schalter/ Steckdose, <b>gerundeter Acryloberboden</b> mit LED-Beleuchtung, 6000 K, 8,5 W 876 Lumen, EEK E  <i>mirror cabinet, 3 mirror doors 6 glass shelves, incl. switch/socket, <b>rounded acryl-top with LED lighting,</b> 6000 K, 8,5 W, 876 lumen, EEC E</i>	90,0	68,2	17,6	<b>SAOE9</b>   Dieses Produkt enthält eine Lichtquelle der Energieeffizienzklasse E	<b>1453</b>
--	---	------	------	------	---	-------------

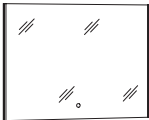
	Spiegelschrank, 3 Spiegeltüren - davon 2 trapezförmig angeordnet, 6 Glasein- legeböden, inkl. Schalter/Steckdose, <b>seitlich und oben LED-Beleuchtung,</b> 6000 K, 17,9 W, 960 Lumen, EEK E  <i>mirror cabinet, 3 mirror doors - 2 of them are arranged in a trapeze, 6 glass shelves, incl. switch/socket, <b>lateral and top LED lighting,</b> 6000 K, 17,9 W, 960 lumen, EEC E</i>	90,0	68,2	17,6	<b>SDU9</b>   Dieses Produkt enthält eine Lichtquelle der Energieeffizienzklasse E	<b>2238</b>
--	--	------	------	------	--	-------------









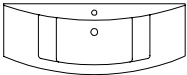

EEK/EEC=Energieeffizienzklasse/energy efficiency category.

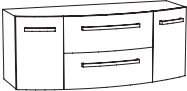
Leuchtmittel sind nicht austauschbar / illuminants are not interchangeable.

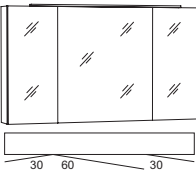
Beschreibung Description	Maße in cm Dimensions in cm			Artikel-Nr. Article no.	Türanschlag Door stop	Identnummer ID number
	B/W	H	T/D			
 <p>Spiegelpaneel, Sensorschalter, seitliche LED-Beleuchtung 6000 K, 2x 6,3 W, 2x 660 Lumen, EEK F <b>Helligkeit dimmbar</b></p> <p><i>mirror panel, sensor switch, lateral LED-lighting 6000 K, 2x 6,3 W, 2x 660 lumen, EEC F</i> <b>brighthness dimmable</b></p>	90,0	68,2	2,8	<b>SPBSA9</b>	  <p>Dieses Produkt enthält eine Lichtquelle der Energieeffizienzklasse F</p>	<b>1200</b>
 <p>LED-Aufbauleuchte für Spiegelpaneel mit LED-Mini-Stecker, 6000 K, 12,5 W, 1566 Lumen, EEK E <b>Helligkeit dimmbar</b></p> <p><i>LED-lighting for mirror panel with LED-mini-plug, 6000 K, 12,5 W, 1566 lumen, EEC E</i> <b>brighthness dimmable</b></p>	90,0	2,4	10,0	<b>AWP90</b>	  <p>Dieses Produkt enthält eine Lichtquelle der Energieeffizienzklasse E</p>	<b>392</b>

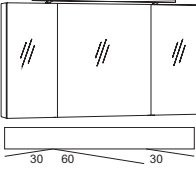

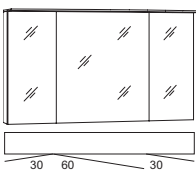



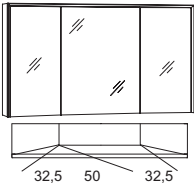

EEK/EEC=Energieeffizienzklasse/energy efficiency category.  
Leuchtmittel sind nicht austauschbar / illuminants are not interchangeable.

# 3040city »120 cm Mineralmarmor/*marble minerals*«

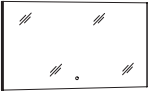
Beschreibung <i>Description</i>	Maße in cm <i>Dimensions in cm</i>			Artikel-Nr. <i>Article no.</i>	Türanschlag <i>Door stop</i>	Identnummer <i>ID number</i>	
	B/W	H	T/D			PG1 <i>Weiß alpin/gloss alpine</i>	PG2 <i>Granit/granite</i>
 <p>Mineralmarmor-Waschtisch inkl. Überlauf <i>marble minerals washbasin incl. overflow</i></p>	122,0	4,0	35,0/ 48,0	<b>CITY120</b> 		<b>PG1</b> 854	<b>PG2</b> 1384
						<b>PG2</b>	<b>PG3</b>
 <p>Waschtisch-Unterschrank 2 Auszüge mittig, 2 Türen <i>washbasin base cabinet 2 extensions in the middle, 2 doors</i></p>	120,0	47,8	34,0/ 47,0	<b>WMCTAAR12</b> ehemals CUA122D-4		<b>1984</b>	<b>2261</b>
 <p>Waschtisch-Unterschrank <b>2 Auszüge, 1 Tür links</b> <i>washbasin base cabinet 2 extensions, 1 door left</i></p>	120,0	47,8	34,0/ 47,0	<b>WMCTAA12</b> ehemals CUAT122DL		<b>1915</b>	<b>2192</b>
 <p>Waschtisch-Unterschrank <b>2 Auszüge, 1 Tür rechts</b> <i>washbasin basin cabinet 2 extensions, 1 door right</i></p>	120,0	47,8	34,0/ 47,0	<b>WMCAAT12</b> ehemals CUAT122DR		<b>1915</b>	<b>2192</b>
<p><b>Aufbauleuchte/top light</b></p>  <p>Spiegelschrank, 3 Spiegeltüren, 6 Glaseinlegeböden, inkl. Schalter/ Steckdose, LED-Aufbauleuchte LL94, 6000 K, 7,4 W, 892 Lumen, EEK E <i>mirror cabinet, 3 mirror doors, 6 glass shelves, incl. switch/socket, LED lighting LL94, 6000 K, 7,4 W 892 lumen, EEC E</i></p>	120,0	68,2	17,6	<b>SLLB12</b>   Dieses Produkt enthält eine Lichtquelle der Energieeffizienzklasse E		<b>1407</b>	
<p><b>Aufbauleuchte/top light</b></p>  <p>Spiegelschrank, 3 Spiegeltüren, 6 Glaseinlegeböden, inkl. Schalter/ Steckdose, LED-Aufbauleuchte RL90, 6000 K, 12,2 W, 1020 Lumen, EEK E <i>mirror cabinet, 3 mirror doors, 6 glass shelves, incl. switch/socket, LED lighting RL90, 6000 K, 12,2 W 1020 lumen, EEC E</i></p>	120,0	68,2	17,6	<b>SPSE120D-4</b>   Dieses Produkt enthält eine Lichtquelle der Energieeffizienzklasse E		<b>1661</b>	
<p><b>Acryloberboden/acryl top</b></p>  <p>Spiegelschrank, 3 Spiegeltüren, 6 Glaseinlegeböden, inkl. Schalter/ Steckdose, <b>gerundeter Acryloberboden</b> mit LED-Beleuchtung, 6000 K, 11,5 W 1380 Lumen, EEK F <i>mirror cabinet, 3 mirror doors 6 glass shelves, incl. switch/socket, <b>rounded acryl-top with LED lighting,</b> 6000 K, 11,5 W, 1380 lumen, EEC F</i></p>	120,0	68,2	17,6	<b>SAOE12</b>   Dieses Produkt enthält eine Lichtquelle der Energieeffizienzklasse F		<b>1661</b>	

EEK/EEC=Energieeffizienzklasse/energy efficiency category.

Leuchtmittel sind nicht austauschbar / illuminants are not interchangeable.



Beschreibung Description	Maße in cm Dimensions in cm			Artikel-Nr. Article no.	Türanschlag Door stop	Identnummer ID number
	B/W	H	T/D			
 <p>Spiegelschrank, 3 Spiegeltüren - davon 2 trapezförmig angeordnet, 6 Glaseinlegeböden, inkl. Schalter/Steckdose, <b>seitlich und oben LED-Beleuchtung</b>, 6000 K, 20,3 W, 960 Lumen, EEK E</p> <p><i>mirror cabinet, 3 mirror doors - 2 of them are arranged in a trapeze, 6 glass shelves, incl. switch/socket, <b>lateral and top LED lighting</b>, 6000 K, 20,3 W, 960 lumen, EEC E</i></p>	120,0	68,2	17,6	<b>SDU12</b>		<b>2468</b>
Dieses Produkt enthält eine Lichtquelle der Energieeffizienzklasse E						
 <p>Spiegelpaneel, Sensorschalter, seitliche LED-Beleuchtung 6000 K, 2x 6,3 W, <b>Helligkeit dimmbar</b></p> <p><i>mirror panel, sensor switch, lateral LED-lighting 6000 K, 2x 6,3 W, <b>brighness dimmable</b></i></p>	120,0	68,2	2,8	<b>SPBSA12</b>	 	<b>1292</b>
Dieses Produkt enthält eine Lichtquelle der Energieeffizienzklasse F						
 <p>LED-Aufbauleuchte für Spiegelpaneel mit LED-Mini-Stecker, 6000 K, 17,3 W, 2160 Lumen, EEK E <b>Helligkeit dimmbar</b></p> <p><i>LED-lighting for mirror panel with LED-mini-plug, 6000 K, 17,3 W, 2160 lumen, EEC E <b>brighness dimmable</b></i></p>	120,0	2,4	10,0	<b>AWP120</b>	 	<b>439</b>
Dieses Produkt enthält eine Lichtquelle der Energieeffizienzklasse E						



EEK/EEC=Energieeffizienzklasse/energy efficiency category.

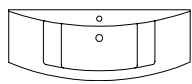

Leuchtmittel sind nicht austauschbar / illuminants are not interchangeable.

# 3040city »120 cm Keramik/ceramic«

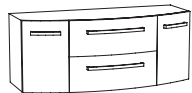
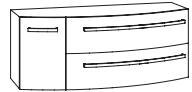

Beschreibung Description	Maße in cm Dimensions in cm			Artikel-Nr. Article no.	Türanschlag Door stop	Identnummer ID number
	B/W	H	T/D			

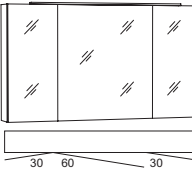
	Keramik-Waschtisch dünn inkl. Überlauf  <i>ceramic washbasin thin incl. overflow</i>	121,0	2,0	40,0/ 51,0	<b>CITYKD120</b> 	<b>1684</b>
--	---	-------	-----	---------------	---	-------------

						PG2	PG3
	Waschtisch-Unterschrank 2 Auszüge mittig, 2 Türen  <i>washbasin base cabinet 2 extensions in the middle, 2 doors</i>	120,0	47,8	33,0/ 47,0	<b>WKBTAA12</b>	<b>2007</b>	<b>2307</b>
	Waschtisch-Unterschrank <b>2 Auszüge, 1 Tür links</b>  <i>washbasin base cabinet 2 extensions, 1 door left</i>	120,0	47,8	33,0/ 47,0	<b>WKBTAA12</b>	<b>1937</b>	<b>2238</b>
	Waschtisch-Unterschrank <b>2 Auszüge, 1 Tür rechts</b>  <i>washbasin base cabinet 2 extensions, 1 door right</i>	120,0	47,8	33,0/ 47,0	<b>WKBAAT12</b>	<b>1937</b>	<b>2238</b>
	Waschtisch-Unterschrank 2 Auszüge  <i>washbasin base cabinet 2 extensions</i>	120,0	47,8	33,0/ 47,0	<b>WKBAAT12</b>	<b>2007</b>	<b>2330</b>

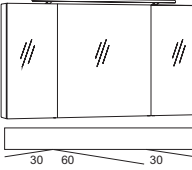

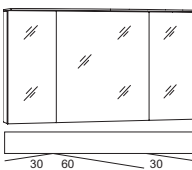





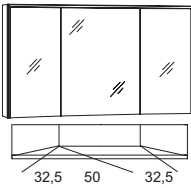

	<b>Aufbauleuchte/top light</b> Spiegelschrank, 3 Spiegeltüren, 6 Glaseinlegeböden, inkl. Schalter/ Steckdose, LED-Aufbauleuchte LL94, 6000 K, 7,4 W, 892 Lumen, EEK E  <i>mirror cabinet, 3 mirror doors, 6 glass shelves, incl. switch/socket, LED lighting LL94, 6000 K, 7,4 W 892 lumen, EEK E</i>	120,0	68,2	17,6	<b>SLLB12</b> 	<b>1407</b>
--	---	-------	------	------	--	-------------

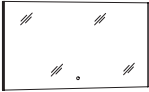
	<b>Aufbauleuchte/top light</b> Spiegelschrank, 3 Spiegeltüren, 6 Glaseinlegeböden, inkl. Schalter/ Steckdose, LED-Aufbauleuchte RL90, 6000 K, 12,2 W, 1020 Lumen, EEK E  <i>mirror cabinet, 3 mirror doors, 6 glass shelves, incl. switch/socket, LED lighting RL90, 6000 K, 12,2 W 1020 lumen, EEK E</i>	120,0	68,2	17,6	<b>SPSE120D-4</b> 	<b>1661</b>
--	---	-------	------	------	--	-------------

	<b>Acryl-oberboden/acryl top</b> Spiegelschrank, 3 Spiegeltüren, 6 Glaseinlegeböden, inkl. Schalter/ Steckdose, <b>gerundeter Acryl-oberboden</b> mit LED-Beleuchtung, 6000 K, 11,5 W 1380 Lumen, EEK F  <i>mirror cabinet, 3 mirror doors 6 glass shelves, incl. switch/socket, <b>rounded acryl-top with LED lighting,</b> 6000 K, 11,5 W, 1380 lumen, EEK F</i>	120,0	68,2	17,6	<b>SAOE12</b> 	<b>1661</b>
--	---	-------	------	------	--	-------------

EEK/EEC=Energieeffizienzklasse/energy efficiency category.  
Leuchtmittel sind nicht austauschbar / illuminants are not interchangeable.











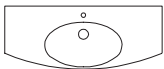

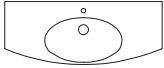
Beschreibung Description	Maße in cm Dimensions in cm			Artikel-Nr. Article no.	Türanschlag Door stop	Identnummer ID number
	B/W	H	T/D			

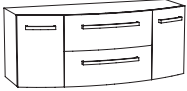
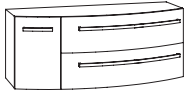
	<p>Spiegelschrank, 3 Spiegeltüren - davon 2 trapezförmig angeordnet, 6 Glaseinlegeböden, inkl. Schalter/Steckdose, <b>seitlich und oben LED-Beleuchtung</b>, 6000 K, 20,3 W, 960 Lumen, EEK E</p> <p><i>mirror cabinet, 3 mirror doors - 2 of them are arranged in a trapeze, 6 glass shelves, incl. switch/socket, <b>lateral and top LED lighting</b>, 6000 K, 20,3 W, 960 lumen, EEC E</i></p>	120,0	68,2	17,6	<p><b>SDU12</b></p>  <p>Dieses Produkt enthält eine Lichtquelle der Energieeffizienzklasse E</p>	2468
	<p>Spiegelpaneel, Sensorschalter, seitliche LED-Beleuchtung 6000 K, 2x 6,3 W, <b>Helligkeit dimmbar</b></p> <p><i>mirror panel, sensor switch, lateral LED-lighting 6000 K, 2x 6,3 W, 2x 660 lumen, EEC F <b>brighness dimmable</b></i></p>	120,0	68,2	2,8	<p><b>SPBSA12</b></p>    <p>Dieses Produkt enthält eine Lichtquelle der Energieeffizienzklasse F</p>	1292
	<p>LED-Aufbauleuchte für Spiegelpaneel mit LED-Mini-Stecker, 6000 K, 17,3 W, 2160 Lumen, EEK E <b>Helligkeit dimmbar</b></p> <p><i>LED-lighting for mirror panel with LED-mini-plug, 6000 K, 17,3 W, 2160 lumen, EEC E <b>brighness dimmable</b></i></p>	120,0	2,4	10,0	<p><b>AWP120</b></p>    <p>Dieses Produkt enthält eine Lichtquelle der Energieeffizienzklasse E</p>	439

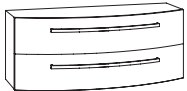
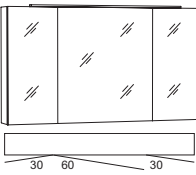
EEK/EEC=Energieeffizienzklasse/energy efficiency category.

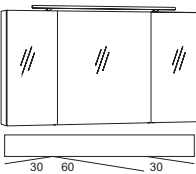
Leuchtmittel sind nicht austauschbar / illuminants are not interchangeable.

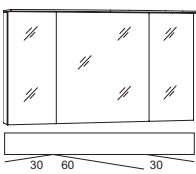
# 3040city »120 cm Glas/Glass«









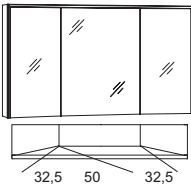

Beschreibung Description	Maße in cm Dimensions in cm			Artikel-Nr. Article no.	Türanschlag Door stop	Identnummer ID number	
	B/W	H	T/D				
 <p>Glas-Waschtisch <b>Weiß Glanz</b> inkl. <b>Überlauf</b> <i>glas washbasin <b>gloss white</b> incl. <b>overflow</b></i></p>	120,4	1,2	47,9	<b>GWESTR12</b> 		<b>2376</b> Weiß Glanz/ <i>gloss white</i>	
 <p>Glas-Waschtisch <b>Anthrazit Matt</b> inkl. <b>Clou-Überlaufsystem</b> <i>glas washbasin <b>matt anthracite</b> incl. <b>Clou overflow system</b></i></p>	120,4	1,2	47,9	<b>GWESTR12C</b> 		<b>2953</b> Anthrazit Matt/ <i>matt anthracite</i>	
						PG2	PG3
 <p>Waschtisch-Unterschrank 2 Auszüge mittig, 2 Türen <i>washbasin base cabinet 2 extensions in the middle, 2 doors</i></p>	120,0	47,8	33,0/ 47,0	<b>WKBTAA12</b> ehemals WGETAAT12		<b>2007</b>	<b>2307</b>
 <p>Waschtisch-Unterschrank 2 Auszüge, 1 Tür links <i>washbasin base cabinet 2 extensions, 1 door left</i></p>	120,0	47,8	33,0/ 47,0	<b>WKBTAA12</b> ehemals WKBTAA12		<b>1937</b>	<b>2238</b>
 <p>Waschtisch-Unterschrank 2 Auszüge, 1 Tür rechts <i>washbasin base cabinet 2 extensions, 1 door right</i></p>	120,0	47,8	33,0/ 47,0	<b>WKBAAT12</b> ehemals WKBTAA12		<b>1937</b>	<b>2238</b>
 <p>Waschtisch-Unterschrank 2 Auszüge <i>washbasin base cabinet 2 extensions</i></p>	120,0	47,8	33,0/ 47,0	<b>WKBAAT12</b> ehemals WMEAA12		<b>2007</b>	<b>2330</b>
<p><b>Aufbauleuchte/top light</b></p>  <p>Spiegelschrank, 3 Spiegeltüren, 6 Glaseinlegeböden, inkl. Schalter/ Steckdose, LED-Aufbauleuchte LL94, 6000 K, 7,4 W, 892 Lumen, EEK E <i>mirror cabinet, 3 mirror doors, 6 glass shelves, incl. switch/socket, LED lighting LL94, 6000 K, 7,4 W 892 lumen, EEC E</i></p>	120,0	68,2	17,6	<b>SLB12</b>   Dieses Produkt enthält eine Lichtquelle der Energieeffizienzklasse E		<b>1407</b>	
<p><b>Aufbauleuchte/top light</b></p>  <p>Spiegelschrank, 3 Spiegeltüren, 6 Glaseinlegeböden, inkl. Schalter/ Steckdose, LED-Aufbauleuchte RL90, 6000 K, 12,2 W, 1020 Lumen, EEK E <i>mirror cabinet, 3 mirror doors, 6 glass shelves, incl. switch/socket, LED lighting RL90, 6000 K, 12,2 W 1020 lumen, EEC E</i></p>	120,0	68,2	17,6	<b>SPSE120D-4</b>   Dieses Produkt enthält eine Lichtquelle der Energieeffizienzklasse E		<b>1661</b>	
<p><b>Acryloberboden/acryl top</b></p>  <p>Spiegelschrank, 3 Spiegeltüren, 6 Glaseinlegeböden, inkl. Schalter/ Steckdose, <b>gerundeter Acryloberboden</b> mit LED-Beleuchtung, 6000 K, 11,5 W 1380 Lumen, EEK F <i>mirror cabinet, 3 mirror doors 6 glass shelves, incl. switch/socket, <b>rounded acryl-top</b> with LED lighting, 6000 K, 11,5 W, 1380 lumen, EEC F</i></p>	120,0	68,2	17,6	<b>SAOE12</b>   Dieses Produkt enthält eine Lichtquelle der Energieeffizienzklasse F		<b>1661</b>	

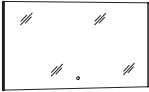
EEK/EEC=Energieeffizienzklasse/energy efficiency category.

Leuchtmittel sind nicht austauschbar / illuminants are not interchangeable.













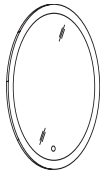

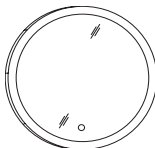

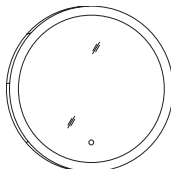

Beschreibung Description	Maße in cm Dimensions in cm			Artikel-Nr. Article no.	Türanschlag Door stop	Identnummer ID number
	B/W	H	T/D			

	<p>Spiegelschrank, 3 Spiegeltüren - davon 2 trapezförmig angeordnet, 6 Glaseinlegeböden, inkl. Schalter/Steckdose, <b>seitlich und oben LED-Beleuchtung</b>, 6000 K, 20,3 W, 960 Lumen, EEK E</p> <p><i>mirror cabinet, 3 mirror doors - 2 of them are arranged in a trapeze, 6 glass shelves, incl. switch/socket, <b>lateral and top LED lighting</b>, 6000 K, 20,3 W, 960 lumen, EEC E</i></p>	120,0	68,2	17,6	<p><b>SDU12</b></p>  <p>Dieses Produkt enthält eine Lichtquelle der Energieeffizienzklasse E</p>	2468
	<p>Spiegelpaneel, Sensorschalter, seitliche LED-Beleuchtung 6000 K, 2x 6,3 W, <b>Helligkeit dimmbar</b></p> <p><i>mirror panel, sensor switch, lateral LED-lighting 6000 K, 2x 6,3 W, <b>brighness dimmable</b></i></p>	120,0	68,2	2,8	<p><b>SPBSA12</b></p>    <p>Dieses Produkt enthält eine Lichtquelle der Energieeffizienzklasse F</p>	1292
	<p>LED-Aufbauleuchte für Spiegelpaneel mit LED-Mini-Stecker, 6000 K, 17,3 W, 2160 Lumen, EEK E <b>Helligkeit dimmbar</b></p> <p><i>LED-lighting for mirror panel with LED-mini-plug, 6000 K, 17,3 W, 2160 lumen, EEC E <b>brighness dimmable</b></i></p>	120,0	2,4	10,0	<p><b>AWP120</b></p>    <p>Dieses Produkt enthält eine Lichtquelle der Energieeffizienzklasse E</p>	439

EEK/EEC=Energieeffizienzklasse/energy efficiency category.











Leuchtmittel sind nicht austauschbar / illuminants are not interchangeable.

# 3040city »Spiegelpaneele und Zubehör/mirror panels and accessories«

Beschreibung Description	Maße in cm Dimensions in cm			Artikel-Nr. Article no.	Türanschlag Door stop	Identnummer ID number
	B/W	H	T/D			
 <p>Spiegelpaneel, Sensorschalter, satiniert, LED Beleuchtung, 4000 K, 17,3 W, 2415 Lumen, EEK G <b>Helligkeit dimmbar</b></p> <p><i>mirror panel, sensor switch, satined, LED-lighting, 4000 K, 17,3 W, 2415 lumen, EEC G</i> <b>brighness dimmable</b></p>	55,0	78,0	2,8	<b>SPE55</b>	  <p>Dieses Produkt enthält eine Lichtquelle der Energieeffizienzklasse G</p>	<b>1131</b>
 <p>Spiegelpaneel, Sensorschalter, satiniert, LED Beleuchtung, 4000 K, 13,5 W, 1890 Lumen, EEK G <b>Helligkeit dimmbar</b></p> <p><i>mirror panel, sensor switch, satined, LED-lighting, 4000 K, 13,5 W, 1890 lumen, EEC G</i> <b>brighness dimmable</b></p>	55,0	55,0	2,8	<b>SPK55</b>	  <p>Dieses Produkt enthält eine Lichtquelle der Energieeffizienzklasse G</p>	<b>992</b>
 <p>Spiegelpaneel, Sensorschalter, satiniert, LED Beleuchtung, 4000 K, 20,8 W, 2905 Lumen, EEK G <b>Helligkeit dimmbar</b></p> <p><i>mirror panel, sensor switch, satined, LED-lighting, 4000 K, 20,8 W, 2905 lumen, EEC G</i> <b>brighness dimmable</b></p>	78,0	78,0	2,8	<b>SPK78</b>	  <p>Dieses Produkt enthält eine Lichtquelle der Energieeffizienzklasse G</p>	<b>1292</b>
 <p>LED-Band für <b>Mineralmarmor WT</b> CITYR60 rund, inkl. Bewegungssensor 6000 K, 6,7 W, 504 Lumen, EEK G</p> <p><i>LED strip for <b>marble minerals wb</b> CITYR60 round, incl. motion sensor, 6000 K, 6,7 W, 504 lumen, EEC G</i></p>				<b>WLED60R</b>	  <p>Dieses Produkt enthält eine Lichtquelle der Energieeffizienzklasse G</p>	<b>277</b>
 <p>LED-Band für <b>Mineralmarmor WT</b> CITYR90 rund, inkl. Bewegungssensor 6000 K, 8,2 W, 1224 Lumen, EEK G</p> <p><i>LED strip for <b>marble minerals wb</b> CITYR90 round, incl. motion sensor, 6000 K, 8,2 W, 1224 lumen, EEC G</i></p>				<b>WLED90R</b>	  <p>Dieses Produkt enthält eine Lichtquelle der Energieeffizienzklasse G</p>	<b>300</b>
 <p>LED-Band für <b>Keramik WT</b> CITYKD90 rund, inkl. Bewegungssensor 6000 K, 4,3 W, 324 Lumen, EEK G</p> <p><i>LED strip for <b>ceramics wb</b> CITYKD90 round, incl. motion sensor, 6000 K, 4,3 W, 324 lumen, EEC G</i></p>				<b>WLEDK90R</b>	  <p>Dieses Produkt enthält eine Lichtquelle der Energieeffizienzklasse G</p>	<b>231</b>

EEK/EEC=Energieeffizienzklasse/energy efficiency category  
Leuchtmittel sind nicht austauschbar / illuminants are not interchangeable.

Beschreibung Description	Maße in cm Dimensions in cm			Artikel-Nr. Article no.	Türanschlag Door stop	Identnummer ID number
	B/W	H	T/D			

 <p>LED-Band für <b>Mineralmarmor WT</b> CITYR120 rund, inkl. Bewegungssensor 6000 K, 9,2 W, 684 Lumen, EEK G</p> <p><i>LED strip for <b>marble minerals wb</b> CITYR120 round, incl. motion sensor, 6000 K, 9,2 W, 684 lumen, EEC G</i></p>				<p><b>WLED120R</b></p>   <p>Dieses Produkt enthält eine Lichtquelle der Energieeffizienzklasse G</p>		<b>323</b>
 <p>LED-Band für <b>Keramik WT</b> CITYKD120 rund, inkl. Bewegungssensor 6000 K, 5,8 W, 432 Lumen, EEK G</p> <p><i>LED strip for <b>ceramics wb</b> CITYKD120 round, incl. motion sensor, 6000 K, 5,8 W, 432 lumen, EEC G</i></p>				<p><b>WLEDK120R</b></p>   <p>Dieses Produkt enthält eine Lichtquelle der Energieeffizienzklasse G</p>		<b>254</b>
 <p>Strass-Dekorband für <b>Mineralmarmor WT</b></p> <p><i>rhinestone decorative strip for <b>marble minerals wb</b></i></p>	215,0			<b>WSTR</b>		<b>111</b>
 <p>Schubkasteneinsatz (Kunststoff) nur für oberen Auszug vom WT-Unterschrank WMCAAR6, WMCTAAR12, WKBTAAT12 rund</p> <p><i>drawer insert part (plastic) only for top drawer from base cabinet round WMCAAR6, WMCTAAR12, WKBTAAT12</i></p>	33,7	4,3	30,6	<b>SCIBEG3</b>		<b>69</b>
 <p>Steckdose/Powerbox für Spiegelschränke Ausführung <b>Schweiz</b> IP44 mit USB-C Stecker</p> <p><i>Power socket for mirror cabinets <b>Switzerland</b> type IP44 with USB-C plug</i></p>				<b>Mehrpreis extra charge</b>		<b>138</b>
 <p>Steckdose/Powerbox für Spiegelschränke Ausführung <b>Frankreich</b> mit USB-C Stecker</p> <p><i>Power socket for mirror cabinets <b>France</b> type with USB-C plug</i></p>				<b>Mehrpreis extra charge</b>		<b>138</b>

EEK/EEC=Energieeffizienzklasse/energy efficiency category  
Leuchtmittel sind nicht austauschbar / illuminants are not interchangeable.

**i** Weiteres Zubehör finden Sie im Register 3970 und Beistellschränke im Register 3990.  
*Further accessoires can be found in register 3970 and side cabinets in register 3990.*





# 3060daily





## Piktogramme/pictograms



Keramik Waschtisch  
Ceramic washbasin



LED Lichtfarbe kalt  
LED colour temperature cold



LED mit Sensorschalter,  
Helligkeit dimmbar  
LED with sensor switch,  
brightness dimmable



LED Lichtfarbe warm  
LED colour temperature warm

## Keramik Waschtisch weiß alpin Glanz (KOK) Ceramic washbasin gloss alpine white (KOK)

≈ Beckenmaße in cm (BxHxT)  
basin dimensions in cm (WxHxD)

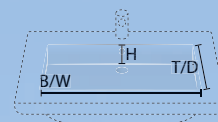

KWKOM65 | 54,5 x 11,5 x 39 cm



KWKOM85 | 65,5 x 11,5 x 38,5 cm



KWKOM95 | 65,5 x 11,5 x 38,5 cm



Detail

**!** Immer im Lieferumfang der Keramikwaschtische enthalten: Befestigungsmaterial MONK-4  
Always included in the scope of delivery of the ceramic washbasins: mounting material MONK-4

Wir empfehlen eine Montage nur durch einen qualifizierten Monteur/Installateur. Keine Haftung bei unsachgemäßer Montage.  
MONK-4: 2 Stockschrauben M10x120 inkl. Dübel für massive Steinwand. Bei anderen Wandbeschaffenheiten müssen im Fachhandel entsprechende Dübel erworben werden.

We recommend installation only by a qualified fitter / installer. No liability for improper installation.  
MONK-4: 2 screws M10x120 including dowels for a solid stone wall. For other wall conditions, suitable dowels must be purchased from a specialised dealer.

## Schränke/cabinets 3060daily

### Frontfarben/front colours

#### Dickkante/thick edge

286



**Weiß Seidenglanz**  
Silk Gloss White  
KOE\_

284



**Anthrazit Seidenglanz**  
Silk Gloss Anthracite  
KOA\_

490



**Kastanie Graphit Nachbildung** NEW  
Graphite Chestnut Finish  
KOC\_

473



**Eiche Struktur Natur Nachbildung** NEW  
Oak Structure Nature Finish  
KOM\_

435



**Eiche Struktur Weiß Nachbildung** NEW  
Oak Structure White Finish  
KOL\_

426



**Eiche Struktur Braun Nachbildung** NEW  
Oak Structure Brown Finish  
KOH\_

### Korpusfarben/basic shell colours

#### PG 1 Dickkante/thick edge

286



**Weiß Seidenglanz**  
Silk Gloss White  
E/KO86

284



**Anthrazit Seidenglanz**  
Silk Gloss Anthracite  
A/KO84

490



**Kastanie Graphit Nachbildung** NEW  
Graphite Chestnut Finish  
C/KO45

473



**Eiche Struktur Natur Nachbildung** NEW  
Oak Structure Nature Finish  
M/KO55

435



**Eiche Struktur Weiß Nachbildung** NEW  
Oak Structure White Finish  
L/KO40

426



**Eiche Struktur Braun Nachbildung** NEW  
Oak Structure Brown Finish  
H/KO70

### Griffe/handles



**Chrom Glanz**  
Gloss Chrome  
Griffnummer/handle number: 281/282  
⌀-⌀ 160 mm/416 mm

⌀-⌀ = Bohrabstand/hole spacing

Die Angabe einer Griffnummer ist ausreichend. Die Griffe werden passend zur jeweiligen Schrankbreite beigelegt.  
The indication of one handle number is sufficient. The handles are supplied to match the respective cabinet width.



## Beleuchtung / lighting



**Aufbauleuchte LED**  
*Top light LED*



**Aufbauleuchte LED**  
*Top light LED*

### Lichtfarbe Tageslicht (Kalt)

*Luminous colour natural light (cold)*













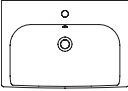

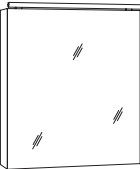

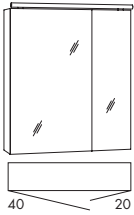
AN60

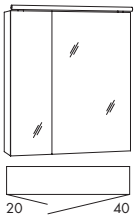

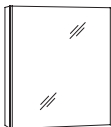
AW60, AWP60,  
AW80, AWP80,  
AW90, AWP90







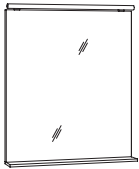

**Die Steckdose / Powerbox für Spiegelschränke ist auch in Ausführung für die Schweiz / Frankreich erhältlich. Bitte Mehrpreis beachten (siehe Seite 10).**  
*The power socket for mirror cabinets is also available for Switzerland / France. Please note extra charge (see page 10).*

# 3060daily »65 cm Keramik/ceramic«

Beschreibung Description	Maße in cm Dimensions in cm			Artikel-Nr. Article no.	Türanschlag Door stop	Identnummer ID number	
	B/W	H	T/D				
 <p>Keramik-Waschtisch inkl. Überlauf und Befestigungsmaterial</p> <p><i>ceramic washbasin incl. overflow and mounting material</i></p>	65,0	6,0	45,0	<b>KWKOM65</b>		670	
							
						PG1	
 <p>Waschtisch-Unterschrank 2 Auszüge</p> <p><i>washbasin base cabinet 2 extensions</i></p>	60,0	49,5	42,5	<b>WKKAA6</b>		1038	
<b>Aufbauleuchte/top light</b>	 <p>Spiegelschrank, 1 Spiegeltür, 2 Glaseinlegeböden, inkl. Schalter/ Steckdose, LED Aufbauleuchte AN60 6000 K, 6,5 W, 320 Lumen, EEK G</p> <p><i>mirror cabinet, 1 mirror door, 2 glass boards, incl. switch/socket, LED lighting AN60, 6000 K, 6,5 W, 320 lumen, EEC G</i></p>	60,0	68,2	17,6	<b>SANB6L SANB6R</b>	Links/ <i>left</i> Rechts/ <i>right</i>	1078
						Dieses Produkt enthält eine Lichtquelle der Energieeffizienzklasse G	
<b>Aufbauleuchte/top light</b>	 <p>Spiegelschrank, 2 Spiegeltüren mit aufgeklebtem Innenspiegel, 2 Glaseinlegeböden, inkl. Schalter/ Steckdose, LED-Aufbauleuchte AN60, 6000 K, 6,5 W, 320 Lumen, EEK G</p> <p><i>mirror cabinet, 2 mirrored doors with glued-on interior mirror, 2 glass boards, incl. switch/socket, LED lighting AN60, 6000 K, 6,5 W, 320 lumen, EEC G</i></p>	60,0	68,2	17,6	<b>SANB6L</b>		1179
						Dieses Produkt enthält eine Lichtquelle der Energieeffizienzklasse G	
<b>Aufbauleuchte/top light</b>	 <p>Spiegelschrank, 2 Spiegeltüren mit aufgeklebtem Innenspiegel, 2 Glaseinlegeböden, inkl. Schalter/ Steckdose, LED-Aufbauleuchte AN60, 6000 K, 6,5 W, 320 Lumen, EEK G</p> <p><i>mirror cabinet, 2 mirrored doors with glued-on interior mirror, 2 glass boards, incl. switch/socket, LED lighting AN60, 6000 K, 6,5 W, 320 lumen, EEC G</i></p>	60,0	68,2	17,6	<b>SANB6R</b>		1179
						Dieses Produkt enthält eine Lichtquelle der Energieeffizienzklasse G	
 <p>Spiegelschrank, 1 beidseitig verspiegelte Tür, 2 Glaseinlegeböden, inkl. Schalter/ Steckdose, seitliche LED-Beleuchtung, 6000 K, 2x 6,3 W, 2x 660 Lumen, EEK F</p> <p><i>mirror cabinet, 1 door mirrored on both sides, 2 glass boards, incl. switch/socket lateral LED-lighting, 6000 K, 2x 6,3 W, 2x 660 lumen, EEC F</i></p>	60,0	68,2	13,6	<b>SAD6L SAD6R</b>	Links/ <i>left</i> Rechts/ <i>right</i>	1338	
						Dieses Produkt enthält eine Lichtquelle der Energieeffizienzklasse F	
 <p>LED-Aufbauleuchte für Spiegelschrank mit LED-Mini-Stecker, 6000 K, 8,2 W, 1026 Lumen, EEK E</p> <p><i>LED-lighting for mirror cabinet with LED-mini-plug, 6000 K, 8,2 W, 1026 lumen, EEC E</i></p>	60,0	2,4	20,0	<b>AW60</b>		370	
						Dieses Produkt enthält eine Lichtquelle der Energieeffizienzklasse E	









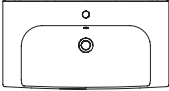

EEK/EEC=Energieeffizienzklasse/energy efficiency category  
Leuchtmittel sind nicht austauschbar / illuminants are not interchangeable.

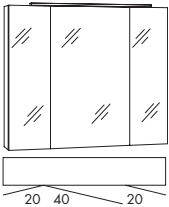
# 3060daily »65 cm Keramik/ceramic«

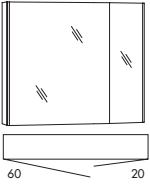

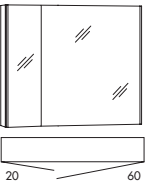



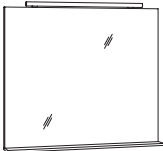

Beschreibung Description	Maße in cm Dimensions in cm			Artikel-Nr. Article no.	Türanschlag Door stop	Identnummer ID number
	B/W	H	T/D			
<p><b>Aufbauleuchte/top light</b></p>  <p>Spiegelpaneel mit Glasablage 60x1x12 cm, inkl. Schalter seitlich Mitte rechts, LED Aufbauleuchte AN60, 6000 K, 6,5 W, 320 Lumen, EEK G</p> <p><i>mirror panel with glas board 60x1x12 cm incl. switch lateral centre right LED lighting AN60, 6000 K, 6,5 W, 320 lumen, EEC G</i></p>	60,0	69,2	3,0	<b>SPANB6</b>		<b>808</b>
Dieses Produkt enthält eine Lichtquelle der Energieeffizienzklasse G						
 <p>Spiegelpaneel, Sensorschalter, seitliche LED-Beleuchtung 6000 K, 2x 6,3 W, 2x 660 Lumen, EEK F <b>Helligkeit dimmbar</b></p> <p><i>mirror panel, sensor switch, lateral LED-lighting 6000 K, 2x 6,3 W, 2x 660 lumen, EEC F</i> <b>brighthness dimmable</b></p>	60,0	68,2	2,8	<b>SPBSA6</b>	 	<b>1107</b>
Dieses Produkt enthält eine Lichtquelle der Energieeffizienzklasse F						
 <p>LED-Aufbauleuchte für Spiegelpaneel mit LED-Mini-Stecker, 6000 K, 8,6 W, 792 Lumen, EEK E <b>Helligkeit dimmbar</b></p> <p><i>LED-lighting for mirror panel with LED-mini-plug, 6000 K, 8,6 W, 792 lumen, EEC E</i> <b>brighthness dimmable</b></p>	60,0	2,4	10,0	<b>AWP60</b>	 	<b>323</b>
Dieses Produkt enthält eine Lichtquelle der Energieeffizienzklasse E						

EEK/EEC=Energieeffizienzklasse/energy efficiency category  
Leuchtmittel sind nicht austauschbar / illuminants are not interchangeable.

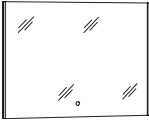
# 3060daily »85 cm Keramik/ceramic«

Beschreibung Description	Maße in cm Dimensions in cm			Artikel-Nr. Article no.	Türanschlag Door stop	Identnummer ID number
	B/W	H	T/D			
 <p>Keramik-Waschtisch inkl. Überlauf und Befestigungsmaterial</p> <p><i>ceramic washbasin incl. overflow and mounting material</i></p>	85,0	6,0	45,0	<b>KWKOM85</b>		<b>785</b>
						PG1
 <p>Waschtisch-Unterschrank 2 Auszüge</p> <p><i>washbasin base cabinet 2 extensions</i></p>	80,0	49,5	42,5	<b>WKKAAB</b>		<b>1085</b>
<p><b>Aufbauleuchte/top light</b></p>  <p>Spiegelschrank, 3 Spiegeltüren, 6 Glaseinlegeböden, inkl. Schalter/ Steckdose, LED Aufbauleuchte AN60 6000 K, 6,5 W, 320 Lumen, EEK G</p> <p><i>mirror cabinet, 3 mirror doors, 6 glass boards, incl. switch/socket, LED lighting AN60, 6000 K, 6,5 W, 320 lumen, EEK G</i></p>	80,0	68,2	17,6	<b>SANB8</b>		<b>1362</b>
					Dieses Produkt enthält eine Lichtquelle der Energieeffizienzklasse G	
 <p>Spiegelschrank, 2 beidseitig verspiegelte Türen, 2 Glaseinlegeböden, inkl. Schalter/ Steckdose, seitliche LED-Beleuchtung, 6000 K, 2x 6,3 W, 2x 660 Lumen, EEK F</p> <p><i>mirror cabinet, 2 doors mirrored on both sides, 2 glass boards, incl. switch/socket lateral LED-lighting, 6000 K, 2x 6,3 W, 2x 660 lumen, EEK F</i></p>	80,0	68,2	13,6	<b>SAD8L</b>		<b>1684</b>
					Dieses Produkt enthält eine Lichtquelle der Energieeffizienzklasse F	
 <p>Spiegelschrank, 2 beidseitig verspiegelte Türen, 2 Glaseinlegeböden, inkl. Schalter/ Steckdose, seitliche LED-Beleuchtung, 6000 K, 2x 6,3 W, 2x 660 Lumen, EEK F</p> <p><i>mirror cabinet, 2 doors mirrored on both sides, 2 glass boards, incl. switch/socket lateral LED-lighting, 6000 K, 2x 6,3 W, 2x 660 lumen, EEK F</i></p>	80,0	68,2	13,6	<b>SAD8R</b>		<b>1684</b>
					Dieses Produkt enthält eine Lichtquelle der Energieeffizienzklasse F	
 <p>LED-Aufbauleuchte für Spiegelschrank mit LED-Mini-Stecker, 6000 K, 10,8 W, 1350 Lumen, EEK E</p> <p><i>LED-lighting for mirror cabinet with LED-mini-plug, 6000 K, 10,8 W, 1350 lumen, EEK E</i></p>	80,0	2,4	20,0	<b>AW80</b>		<b>415</b>
					Dieses Produkt enthält eine Lichtquelle der Energieeffizienzklasse E	



EEK/EEC=Energieeffizienzklasse/energy efficiency category  
Leuchtmittel sind nicht austauschbar / illuminants are not interchangeable.

Beschreibung Description	Maße in cm Dimensions in cm			Artikel-Nr. Article no.	Türanschlag Door stop	Identnummer ID number
	B/W	H	T/D			
<p><b>Aufbauleuchte/top light</b></p>  <p>Spiegelpaneel mit Glasablage 80x1x12 cm, inkl. Schalter seitlich Mitte rechts, LED Aufbauleuchte AN60, 6000 K, 6,5 W, 320 Lumen, EEK G</p> <p><i>mirror panel with glas board 80x1x12 cm incl. switch lateral centre right LED lighting AN60, 6000 K, 6,5 W, 320 lumen, EEC G</i></p>	80,0	69,2	3,0	<b>SPANB8</b> 		<b>881</b>
Dieses Produkt enthält eine Lichtquelle der Energieeffizienzklasse G						
 <p>Spiegelpaneel, Sensorschalter, seitliche LED-Beleuchtung 6000 K, 2x 6,3 W, 2x 660 Lumen, EEK F <b>Helligkeit dimmbar</b></p> <p><i>mirror panel, sensor switch, lateral LED-lighting 6000 K, 2x 6,3 W, 2x 660 lumen, EEC F</i> <b>brighness dimmable</b></p>	80,0	68,2	2,8	<b>SPBSA8</b>  		<b>1154</b>
Dieses Produkt enthält eine Lichtquelle der Energieeffizienzklasse F						
 <p>LED-Aufbauleuchte für Spiegelpaneel mit LED-Mini-Stecker, 6000 K, 10,8 W, 1350 Lumen, EEK E <b>Helligkeit dimmbar</b></p> <p><i>LED-lighting for mirror panel with LED-mini-plug, 6000 K, 10,8 W, 1350 lumen, EEC E</i> <b>brighness dimmable</b></p>	80,0	2,4	10,0	<b>AWP80</b>  		<b>369</b>
Dieses Produkt enthält eine Lichtquelle der Energieeffizienzklasse E						



EEK/EEC=Energieeffizienzklasse/energy efficiency category

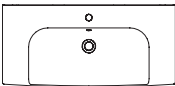

Leuchtmittel sind nicht austauschbar / illuminants are not interchangeable.

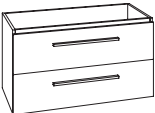
Beschreibung Description	Maße in cm Dimensions in cm			Artikel-Nr. Article no.	Türanschlag Door stop	Identnummer ID number
	B/W	H	T/D			

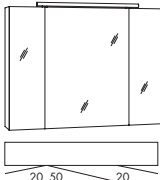
 <p>Keramik-Waschtisch inkl. Überlauf und Befestigungsmaterial</p> <p><i>ceramic washbasin incl. overflow and mounting material</i></p>	95,0	6,0	45,0	<b>KWKOM95</b> 		877
						PG1

 <p>Waschtisch-Unterschrank 2 Auszüge</p> <p><i>washbasin base cabinet 2 extensions</i></p>	90,0	49,5	42,5	<b>WKKAA9</b>		1163

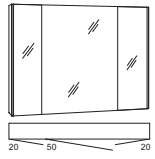







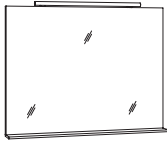

<p><b>Aufbauleuchte/top light</b></p>  <p>Spiegelschrank, 3 Spiegeltüren, 6 Glaseinlegeböden, inkl. Schalter/ Steckdose, LED Aufbauleuchte AN60 6000 K, 6,5 W, 320 Lumen, EEK G</p> <p><i>mirror cabinet, 3 mirror doors, 6 glass boards, incl. switch/socket, LED lighting AN60, 6000 K, 6,5 W, 320 lumen, EEC G</i></p>	90,0	68,2	17,6	<b>SANB9</b> 	<p>Dieses Produkt enthält eine Lichtquelle der Energieeffizienzklasse G</p>	1400

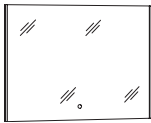
 <p>Spiegelschrank, 3 beidseitig verspiegelte Türen, 6 Glaseinlegeböden, inkl. Schalter/ Steckdose, seitliche LED-Beleuchtung, 6000 K, 2x 6,3 W, 2x 660 Lumen, EEK F</p> <p><i>mirror cabinet, 3 doors mirrored on both sides, 6 glass boards, incl. switch/socket lateral LED-lighting, 6000 K, 2x 6,3 W, 2x 660 lumen, EEC F</i></p>	90,0	68,2	13,6	<b>SAD9A</b> 	<p>Dieses Produkt enthält eine Lichtquelle der Energieeffizienzklasse F</p>	2076
						NEW

 <p>LED-Aufbauleuchte für Spiegelschrank mit LED-Mini-Stecker, 6000 K, 12,5 W, 1566 Lumen, EEK E</p> <p><i>LED-lighting for mirror cabinet with LED-mini-plug, 6000 K, 12,5 W, 1566 lumen, EEC E</i></p>	90,0	2,4	20,0	<b>AW90</b> 	<p>Dieses Produkt enthält eine Lichtquelle der Energieeffizienzklasse E</p>	439
						NEW

EEK/EEC=Energieeffizienzklasse/energy efficiency category  
Leuchtmittel sind nicht austauschbar / illuminants are not interchangeable.

# 3060daily »95 cm Keramik/ceramic«

Beschreibung Description	Maße in cm Dimensions in cm			Artikel-Nr. Article no.	Türanschlag Door stop	Identnummer ID number
	B/W	H	T/D			
<p><b>Aufbauleuchte/top light</b></p>  <p>Spiegelpaneel mit Glasablage 90x1x12 cm, inkl. Schalter seitlich Mitte rechts, LED Aufbauleuchte AN60, 6000 K, 6,5 W, 320 Lumen, EEK G</p> <p><i>mirror panel with glas board 90x1x12 cm incl. switch lateral centre right LED lighting AN60, 6000 K, 6,5 W, 320 lumen, EEC G</i></p>	90,0	69,2	3,0	<b>SPANB9</b> 		950
Dieses Produkt enthält eine Lichtquelle der Energieeffizienzklasse G						
 <p>Spiegelpaneel, Sensorschalter, seitliche LED-Beleuchtung 6000 K, 2x 6,3 W, 2x 660 Lumen, EEK F <b>Helligkeit dimmbar</b></p> <p><i>mirror panel, sensor switch, lateral LED-lighting 6000 K, 2x 6,3 W, 2x 660 lumen, EEC F</i> <b>brighness dimmable</b></p>	90,0	68,2	2,8	<b>SPBSA9</b>   		1200
Dieses Produkt enthält eine Lichtquelle der Energieeffizienzklasse F						
 <p>LED-Aufbauleuchte für Spiegelpaneel mit LED-Mini-Stecker, 6000 K, 12,5 W, 1566 Lumen, EEK E <b>Helligkeit dimmbar</b></p> <p><i>LED-lighting for mirror panel with LED-mini-plug, 6000 K, 12,5 W, 1566 lumen, EEC E</i> <b>brighness dimmable</b></p>	90,0	2,4	10,0	<b>AWP90</b>   		392
Dieses Produkt enthält eine Lichtquelle der Energieeffizienzklasse E						

EEK/EEC=Energieeffizienzklasse/energy efficiency category

Leuchtmittel sind nicht austauschbar / illuminants are not interchangeable.

# 3060daily »Spiegelpaneele und Zubehör/ mirror panels and accessoires«

Beschreibung Description	Maße in cm Dimensions in cm			Artikel-Nr. Article no.	Türanschlag Door stop	Identnummer ID number
	B/W	H	T/D			
 <p>Spiegelpaneel, Sensorschalter, satiniert, LED Beleuchtung, 4000 K, 17,3 W, 2415 Lumen, EEK G <b>Helligkeit dimmbar</b></p> <p><i>mirror panel, sensor switch, satined, LED-lighting, 4000 K, 17,3 W, 2415 lumen, EEC G</i> <b>brighness dimmable</b></p>	55,0	78,0	2,8	<b>SPE55</b>   Dieses Produkt enthält eine Lichtquelle der Energieeffizienzklasse G	1131	
 <p>Spiegelpaneel, Sensorschalter, satiniert, LED Beleuchtung, 4000 K, 13,5 W, 1890 Lumen, EEK G <b>Helligkeit dimmbar</b></p> <p><i>mirror panel, sensor switch, satined, LED-lighting, 4000 K, 13,5 W, 1890 lumen, EEC G</i> <b>brighness dimmable</b></p>	55,0	55,0	2,8	<b>SPK55</b>   Dieses Produkt enthält eine Lichtquelle der Energieeffizienzklasse G	992	
 <p>Spiegelpaneel, Sensorschalter, satiniert, LED Beleuchtung, 4000 K, 20,8 W, 2905 Lumen, EEK G <b>Helligkeit dimmbar</b></p> <p><i>mirror panel, sensor switch, satined, LED-lighting, 4000 K, 20,8 W, 2905 lumen, EEC G</i> <b>brighness dimmable</b></p>	78,0	78,0	2,8	<b>SPK78</b>   Dieses Produkt enthält eine Lichtquelle der Energieeffizienzklasse G	1292	
 <p>Schubkasteneinsatz (Kunststoff) für oberen Auszug vom WT-Unterschrank</p> <p><i>drawer insert part (plastic) for top drawer from base cabinet</i></p>	33,7	4,3	33,0	<b>SMBEG3</b>	69	
 <p>Steckdose/Powerbox für Spiegelschränke Ausführung <b>Schweiz</b> IP44 mit USB-C Stecker</p> <p><i>Power socket for mirror cabinets Switzerland type IP44 with USB-C plug</i></p>				<b>Mehrpreis extra charge</b>	138	
 <p>Steckdose/Powerbox für Spiegelschränke Ausführung <b>Frankreich</b> mit USB-C Stecker</p> <p><i>Power socket for mirror cabinets France type with USB-C plug</i></p>				<b>Mehrpreis extra charge</b>	138	

EEK/EEC=Energieeffizienzklasse/energy efficiency category  
Leuchtmittel sind nicht austauschbar / illuminants are not interchangeable.

**i** Weiteres Zubehör finden Sie im Register 3970 und Beistellschränke im Register 3990.  
Further accessoires can be found in register 3970 and side cabinets in register 3990.





# 3090cosmo





# »3090cosmo«

Piktogramme/pictograms



Mineralmarmor Waschtisch  
Marble minerals washbasin



LED Lichtfarbe kalt  
LED colour temperature cold



LED Lichtfarbe regelbar,  
Helligkeit dimmbar  
LED colour temperature adjust-  
able, brightness dimmable



LED Lichtfarbe warm  
LED colour temperature warm



LED mit Sensorschalter,  
Helligkeit dimmbar  
LED with sensor switch,  
brightness dimmable

## Mineralmarmor Waschtisch weiß alpin Glanz (CO69) Marble minerals washbasin gloss alpine white (CO69)

»3090cosmo« (MWRC/MWC)

≈ Beckenmaße in cm (BxHxT)  
basin dimensions in cm (WxHxD)

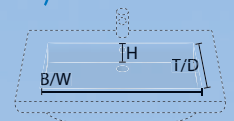

MWRC60



Detail



MWC90R



MWC90L



MWC120R



MWC120L



MWC120M



MWC150D

Alle Becken/all basins = 59,1 x 12 x 33,7 cm

## Schränke/cabinets 3090cosmo

### Frontfarben/front colours

#### MDF-foliiert/MDF-coated

449



**Kastanie Graphit Nachbildung**  
*Graphite Chestnut Finish*  
COC\_

273



**Eiche Struktur Natur Nachbildung**  
*Oak Structure Nature Finish*  
COM\_

235



**Eiche Struktur Weiß Nachbildung** NEW  
*Oak Structure White Finish*  
COL\_

226



**Eiche Struktur Braun Nachbildung** NEW  
*Oak Structure Brown Finish*  
COH\_

961



**Weiß Glanz**  
*Gloss White*  
COG\_

438



**Anthrazit Glanz**  
*Gloss Anthracite*  
COF\_

### Korpusfarben/basic shell colours

#### PG 2 Dickkante/thick edge

490



**Kastanie Graphit Nachbildung**  
*Graphite Chestnut Finish*  
C/CO45

473



**Eiche Struktur Natur Nachbildung**  
*Oak Structure Nature Finish*  
M/CO55

435



**Eiche Struktur Weiß Nachbildung** NEW  
*Oak Structure White Finish*  
L/CO40

426



**Eiche Struktur Braun Nachbildung** NEW  
*Oak Structure Brown Finish*  
H/CO70

#### PG 3 MDF-foliiert/MDF-coated

042



**Weiß Glanz Folie**  
*Gloss White*  
G/CO50

438



**Anthrazit Glanz Folie**  
*Gloss Anthracite*  
F/CO30

# »3090cosmo«

## Regalfarben/ shelf colours

287



**Weiß Seidenglanz**  
Silk Gloss White  
CO86

285



**Anthrazit Seidenglanz**  
Silk Gloss Anthracite  
CO84

491



**Kastanie Graphit Nachbildung**  
Graphite Chestnut Finish  
CO45

474



**Eiche Struktur Natur Nachbildung**  
Oak Structure Nature Finish  
CO55

436



**Eiche Struktur Weiß Nachbildung** NEW  
Oak Structure White Finish  
CO40

427



**Eiche Struktur Braun Nachbildung** NEW  
Oak Structure Brown Finish  
CO70

## Griffe/handles



**Chrom Glanz**  
Gloss Chrome

Griffnummer/handlenumber: 134/138/139  
⌀-⌀ 384/96/460 mm



**Chrom Glanz**  
Gloss Chrome

Griffnummer/handlenumber: 334/338/339  
⌀-⌀ 384/160/320 mm



**Chrom Glanz**  
Gloss Chrome

Griffnummer/handlenumber: 434/438/439  
⌀-⌀ 320/160/320 mm

⌀-⌀ = Bohrabstand/hole spacing

Die Angabe einer Griffnummer ist ausreichend. Die Griffe werden passend zur jeweiligen Schrankbreite beigelegt.  
The indication of one handle number is sufficient. The handles are supplied to match the respective cabinet width.

## Beleuchtung / lighting



**Aufbauleuchte LED**  
Top light LED



**Acryloberboden LED**  
Acrylic top LED



**Aufbauleuchte LED**  
Top light LED

**Lichtfarbe Tageslicht (Kalt)**  
Luminous colour natural light (cold)



FLL60, FLL90  
FLS60, FLS90



AWP60,  
AWP90,  
AWP120

**Lichtfarbe Wohlfühllicht (Warm)**  
Luminous colour warm light





FLS60, FLS90



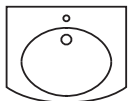

Die Steckdose / Powerbox für Spiegelschränke ist auch in Ausführung für die Schweiz / Frankreich erhältlich. Bitte Mehrpreis beachten (siehe Seite 18).  
The power socket for mirror cabinets is also available for Switzerland / France. Please note extra charge (see page 18).

# 3090cosmo »60 cm Mineralmarmor/marble minerals«

Beschreibung Description	Maße in cm Dimensions in cm			Artikel-Nr. Article no.	Türanschlag Door stop	Identnummer ID number
	B/W	H	T/D			

	Mineralmarmor-Waschtisch inkl. Überlauf  <i>marble minerals washbasin incl. overflow</i>	60,4	2,0	41,5/ 49,5	<b>MWRC60</b> 	<b>923</b>
---	---	------	-----	---------------	--	------------

						PG2	PG3
	Waschtisch-Unterschrank 2 Auszüge  <i>washbasin base cabinet 2 extensions</i>	60,0	47,8	40,3/ 48,0	<b>WUAR62D</b>	<b>1500</b>	<b>1661</b>

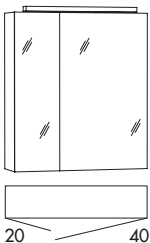

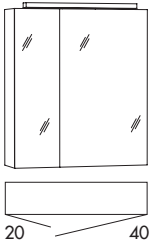

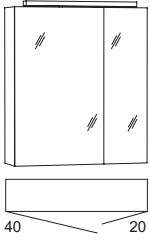

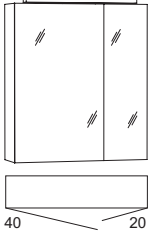



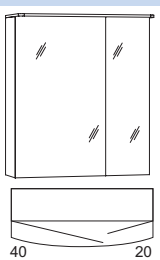

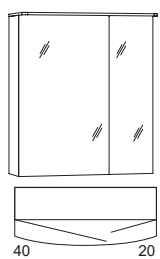

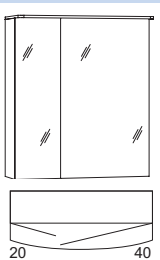

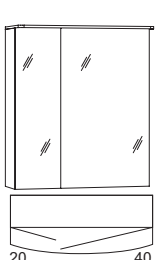
Aufbauleuchte/top light	Spiegelschrank, 2 beidseitig verspiegelte Türen, 2 Glaseinlegeböden, inkl. Schalter/Steckdose, <b>LED Aufbauleuchte FLL60</b> 6000 K, 11,5 W, 1168 Lumen, EEK E	60,0	68,2	17,6	<b>SSFGS24</b> 	<b>1753</b>
	<i>mirror cabinet, 2 doors mirrored on both sides, 2 glass boards, incl. switch/socket</i> <b>LED lighting FLL60, 6000 K, 11,5 W, 1168 lumen, EEC E</b>				Dieses Produkt enthält eine Lichtquelle der Energieeffizienzklasse E	

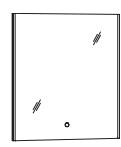
Aufbauleuchte/top light	Spiegelschrank, 2 beidseitig verspiegelte Türen, 2 Glaseinlegeböden, inkl. Schalter/Steckdose, <b>LED Aufbauleuchte FLS60</b> 2800-6500 K, 12 W, 926 Lumen, EEK G Helligkeit dimmbar	60,0	68,2	17,6	<b>SSFGZ24</b> 	<b>2145</b>
	<i>mirror cabinet, 2 doors mirrored on both sides, 2 glass boards, incl. switch/socket</i> <b>LED lighting FLS60, 2800-6500 K, 12 W, 926 lumen, EEC G</b> <b>brighness dimmable</b>				Dieses Produkt enthält eine Lichtquelle der Energieeffizienzklasse G	

Aufbauleuchte/top light	Spiegelschrank, 2 beidseitig verspiegelte Türen, 2 Glaseinlegeböden, inkl. Schalter/Steckdose, <b>LED Aufbauleuchte FLL60</b> 6000 K, 11,5 W, 1168 Lumen, EEK E	60,0	68,2	17,6	<b>SSFGS42</b> 	<b>1753</b>
	<i>mirror cabinet, 2 doors mirrored on both sides, 2 glass boards, incl. switch/socket</i> <b>LED lighting FLL60, 6000 K, 11,5 W, 1168 lumen, EEC E</b>				Dieses Produkt enthält eine Lichtquelle der Energieeffizienzklasse E	

Aufbauleuchte/top light	Spiegelschrank, 2 beidseitig verspiegelte Türen, 2 Glaseinlegeböden, inkl. Schalter/Steckdose, <b>LED Aufbauleuchte FLS60</b> 2800-6500 K, 12 W, 926 Lumen, EEK G Helligkeit dimmbar	60,0	68,2	17,6	<b>SSFGZ42</b> 	<b>2145</b>
	<i>mirror cabinet, 2 doors mirrored on both sides, 2 glass boards, incl. switch/socket</i> <b>LED lighting FLS60, 2800-6500 K, 12 W, 926 lumen, EEC G</b> <b>brighness dimmable</b>				Dieses Produkt enthält eine Lichtquelle der Energieeffizienzklasse G	

EEK/EEC=Energieeffizienzklasse/energy efficiency category  
Leuchtmittel sind nicht austauschbar / illuminants are not interchangeable.



Beschreibung Description	Maße in cm Dimensions in cm			Artikel-Nr. Article no.	Türanschlag Door stop	Identnummer ID number
	B/W	H	T/D			
<p>Acryloberboden/acryl top</p>  <p>Spiegelschrank, 2 beidseitig verspiegelte Türen, 2 Glaseinlegeböden, inkl. Schalter/Steckdose, <b>gerundeter Acryloberboden</b> mit LED-Beleuchtung, <b>6000 K, 5,5 W, 660 Lumen, EEK F</b></p> <p><i>mirror cabinet, 2 doors mirrored on both sides, 2 glass boards, incl. switch/socket, <b>rounded acryl-top</b> with LED lighting, <b>6000 K, 5,5 W, 660 lumen, EEC F</b></i></p>	60,0	68,2	17,6	SSAOS42	 <p>Dieses Produkt enthält eine Lichtquelle der Energieeffizienzklasse F</p>	1646
<p>Acryloberboden/acryl top</p>  <p>Spiegelschrank, 2 beidseitig verspiegelte Türen, 2 Glaseinlegeböden, inkl. Schalter/Steckdose, <b>gerundeter Acryloberboden</b> mit LED-Beleuchtung, <b>2800-6500 K, 11,0 W, 1650 Lumen, EEK F Helligkeit dimmbar</b></p> <p><i>mirror cabinet, 2 doors mirrored on both sides, 2 glass boards, incl. switch/socket, <b>rounded acryl-top</b> with LED lighting, <b>2800-6500 K, 11,0 W, 1650 lumen, EEC F brightness dimmable</b></i></p>	60,0	68,2	17,6	SSAOZ42	 <p>Dieses Produkt enthält eine Lichtquelle der Energieeffizienzklasse F</p>	1892
<p>Acryloberboden/acryl top</p>  <p>Spiegelschrank, 2 beidseitig verspiegelte Türen, 2 Glaseinlegeböden, inkl. Schalter/Steckdose, <b>gerundeter Acryloberboden</b> mit LED-Beleuchtung, <b>6000 K, 5,5 W, 660 Lumen, EEK F</b></p> <p><i>mirror cabinet, 2 doors mirrored on both sides, 2 glass boards, incl. switch/socket, <b>rounded acryl-top</b> with LED lighting, <b>6000 K, 5,5 W, 660 lumen, EEC F</b></i></p>	60,0	68,2	17,6	SSAOS24	 <p>Dieses Produkt enthält eine Lichtquelle der Energieeffizienzklasse F</p>	1646
<p>Acryloberboden/acryl top</p>  <p>Spiegelschrank, 2 beidseitig verspiegelte Türen, 2 Glaseinlegeböden, inkl. Schalter/Steckdose, <b>gerundeter Acryloberboden</b> mit LED-Beleuchtung, <b>2800-6500 K, 11,0 W, 1650 Lumen, EEK F Helligkeit dimmbar</b></p> <p><i>mirror cabinet, 2 doors mirrored on both sides, 2 glass boards, incl. switch/socket, <b>rounded acryl-top</b> with LED lighting, <b>2800-6500 K, 11,0 W, 1650 lumen, EEC F brightness dimmable</b></i></p>	60,0	68,2	17,6	SSAOZ24	 <p>Dieses Produkt enthält eine Lichtquelle der Energieeffizienzklasse F</p>	1892
 <p>Spiegelpaneel, Sensorschalter, seitliche LED-Beleuchtung 6000 K, 2x 6,3 W, 2x 660 Lumen, EEK F <b>Helligkeit dimmbar</b></p> <p><i>mirror panel, sensor switch, lateral LED-lighting 6000 K, 2x 6,3 W, 2x 660 lumen, EEC F <b>brightness dimmable</b></i></p>	60,0	68,2	2,8	 <b>SPBSA6</b>   <p>Dieses Produkt enthält eine Lichtquelle der Energieeffizienzklasse F</p>	1107	
 <p>LED-Aufbauleuchte für Spiegelpaneel mit LED-Mini-Stecker, 6000 K, 8,6 W, 792 Lumen, EEK E <b>Helligkeit dimmbar</b></p> <p><i>LED-lighting for mirror panel with LED-mini-plug, 6000 K, 8,6 W, 792 lumen, EEC E <b>brightness dimmable</b></i></p>	60,0	2,4	10,0	 <b>AWP60</b>   <p>Dieses Produkt enthält eine Lichtquelle der Energieeffizienzklasse E</p>	323	

EEK/EEC=Energieeffizienzklasse/energy efficiency category

Leuchtmittel sind nicht austauschbar / luminants are not interchangeable.

# 3090cosmo »90 cm L Mineralmarmor/ marble minerals«

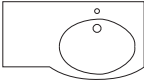
Beschreibung Description	Maße in cm Dimensions in cm			Artikel-Nr. Article no.	Türanschlag Door stop	Identnummer ID number
	B/W	H	T/D			



	Mineralmarmor-Waschtisch inkl. Überlauf  <i>marble minerals washbasin incl. overflow</i>	90,4	2,0	41,5/ 49,5	<b>MWC90L</b> 		<b>1131</b>
--	---	------	-----	---------------	--	--	-------------

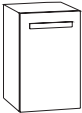

						PG2	PG3
	Waschtisch-Unterschrank 2 Auszüge  <i>washbasin base cabinet 2 extensions</i>	60,0	47,8	40,3/ 48,0	<b>WUAR62D</b>	<b>1500</b>	<b>1661</b>

	Unterschrank 1 Tür, 1 Glaseinlegeboden  <i>base cabinet 1 door, 1 glass shelf</i>	30,0	47,8	40,3	<b>WU30DL</b> Links/ <i>left</i>	<b>486</b>	<b>648</b>
---	--	------	------	------	----------------------------------	------------	------------

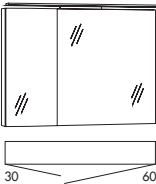
	Unterschrank 1 Einschubregal, 1 Auszug  <i>base cabinet 1 push in shelf, 1 extension</i>	30,0	47,8	40,3	<b>WUEA30D</b>	<b>811</b>	<b>972</b>
--	---	------	------	------	----------------	------------	------------

	Unterschrank 2 Auszüge  <i>base cabinet 2 extensions</i>	30,0	47,8	40,3	<b>WUA32D</b>	<b>900</b>	<b>1038</b>
---	---	------	------	------	---------------	------------	-------------

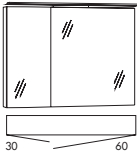
	<b>Aufbauleuchte/top light</b> Spiegelschrank, 2 beidseitig verspiegelte Türen, 2 Glaseinlegeböden, inkl. Schalter/Steckdose, <b>LED Aufbauleuchte FLL90 6000 K</b> , 17,0 W, 1751 Lumen, EEK E  <i>mirror cabinet, 2 doors mirrored on both sides, 2 glass boards, incl. switch/ socket, LED lighting FLL90, 6000 K, 17,0 W, 1751 lumen, EEC E</i>	90,0	68,2	17,6	<b>SSFGS36</b> 		<b>2007</b>
					Dieses Produkt enthält eine Lichtquelle der Energieeffizienzklasse E		

	<b>Aufbauleuchte/top light</b> Spiegelschrank, 2 beidseitig verspiegelte Türen, 2 Glaseinlegeböden, inkl. Schalter/Steckdose, <b>LED Aufbauleuchte FLS90 2800-6500 K</b> , 17,5 W, 1390 Lumen, EEK G, Helligkeit dimmbar  <i>mirror cabinet, 2 doors mirrored on both sides, 2 glass boards, incl. switch/ socket, LED lighting FLS90, 2800-6500 K, 17,5 W, 1390 lumen, EEC G brightness dimmable</i>	90,0	68,2	17,6	<b>SSFGZ36</b> 		<b>2376</b>
					Dieses Produkt enthält eine Lichtquelle der Energieeffizienzklasse G		











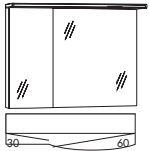

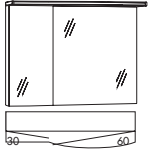
EEK/EEC=Energyeffizienzklasse/energy efficiency category

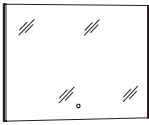
Leuchtmittel sind nicht austauschbar / illuminants are not interchangeable.

 Regalfarben unbedingt mit angeben, Übersicht siehe Seite 3. Please indicate shelf colours, overview see page 3.



# 3090cosmo »90 cm L Mineralmarmor/marble minerals«



Beschreibung Description	Maße in cm Dimensions in cm			Artikel-Nr. Article no.	Türanschlag Door stop	Identnummer ID number
	B/W	H	T/D			
<p>Acryloberboden/acryl top</p>  <p>Spiegelschrank, 2 beidseitig verspiegelte Türen, 2 Glaseinlegeböden, inkl. Schalter/Steckdose, <b>gerundeter Acryloberboden</b> mit LED-Beleuchtung, <b>6000 K</b>, 8,5 W 1020 Lumen, EEK F</p> <p><i>mirror cabinet, 2 doors mirrored on both sides, 2 glass boards, incl. switch/socket, <b>rounded acryl-top</b> with LED lighting, <b>6000 K</b>, 8,5 W, 1020 lumen, EEC F</i></p>	90,0	68,2	17,6	<b>SSAOS36</b>	 <p>Dieses Produkt enthält eine Lichtquelle der Energieeffizienzklasse F</p>	<b>2001</b>
<p>Acryloberboden/acryl top</p>  <p>Spiegelschrank, 2 beidseitig verspiegelte Türen, 2 Glaseinlegeböden, inkl. Schalter/Steckdose, <b>gerundeter Acryloberboden</b> mit LED-Beleuchtung, <b>2800-6500 K</b>, 17,0 W, 2550 Lumen, EEK F <b>Helligkeit dimmbar</b></p> <p><i>mirror cabinet, 2 doors mirrored on both sides, 2 glass boards, incl. switch/socket, <b>rounded acryl-top</b> with LED lighting, <b>2800-6500 K</b>, 17,0 W, 2550 lumen, EEC F <b>brighness dimmable</b></i></p>	90,0	68,2	17,6	<b>SSAOZ36</b>	 <p>Dieses Produkt enthält eine Lichtquelle der Energieeffizienzklasse F</p>	<b>2248</b>
 <p>Spiegelpaneel, Sensorschalter, seitliche LED-Beleuchtung 6000 K, 2x 6,3 W, 2x 660 Lumen, EEK F <b>Helligkeit dimmbar</b></p> <p><i>mirror panel, sensor switch, lateral LED-lighting 6000 K, 2x 6,3 W, 2x 660 lumen, EEC F <b>brighness dimmable</b></i></p>	90,0	68,2	2,8	<b>SPBSA9</b>	   <p>Dieses Produkt enthält eine Lichtquelle der Energieeffizienzklasse F</p>	<b>1200</b>
 <p>LED-Aufbauleuchte für Spiegelpaneel mit LED-Mini-Stecker, 6000 K, 12,5 W, 1566 Lumen, EEK E <b>Helligkeit dimmbar</b></p> <p><i>LED-lighting for mirror panel with LED-mini-plug, 6000 K, 12,5 W, 1566 lumen, EEC E <b>brighness dimmable</b></i></p>	90,0	2,4	10,0	<b>AWP90</b>	   <p>Dieses Produkt enthält eine Lichtquelle der Energieeffizienzklasse E</p>	<b>392</b>

EEK/EEC=Energieeffizienzklasse/energy efficiency category

Leuchtmittel sind nicht austauschbar / illuminants are not interchangeable.

# 3090cosmo »90 cm R Mineralmarmor/ marble minerals«

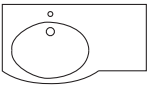
Beschreibung Description	Maße in cm Dimensions in cm			Artikel-Nr. Article no.	Türanschlag Door stop	Identnummer ID number
	B/W	H	T/D			



	Mineralmarmor-Waschtisch inkl. Überlauf	90,4	2,0	41,5/ 49,5	<b>MWC90R</b>		<b>1131</b>
	<i>marble minerals washbasin incl. overflow</i>						

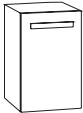

						PG2	PG3
	Waschtisch-Unterschrank 2 Auszüge	60,0	47,8	40,3/ 48,0	<b>WUAR62D</b>	<b>1500</b>	<b>1661</b>
	<i>washbasin base cabinet 2 extensions</i>						

	Unterschrank 1 Tür, 1 Glaseinlegeboden	30,0	47,8	40,3	<b>WU30DR</b>	Rechts/ <i>right</i>	<b>486</b>	<b>648</b>
	<i>base cabinet 1 door, 1 glass shelf</i>							

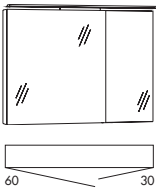
	Unterschrank 1 Einschubregal, 1 Auszug	30,0	47,8	40,3	<b>WUEA30D</b>		<b>811</b>	<b>972</b>
	<i>base cabinet 1 push in shelf, 1 extension</i>							

	Unterschrank 2 Auszüge	30,0	47,8	40,3	<b>WUA32D</b>		<b>900</b>	<b>1038</b>
	<i>base cabinet 2 extensions</i>							

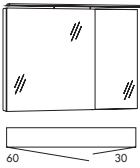
	Aufbauleuchte/ <i>top light</i> Spiegelschrank, 2 beidseitig verspiegelte Türen, 2 Glaseinlegeböden, inkl. Schalter/Steckdose, <b>LED Aufbauleuchte FLL90</b> <b>6000 K, 17,0 W, 1751 Lumen, EEK E</b>	90,0	68,2	17,6	<b>SSFGS63</b>		<b>2007</b>
	<i>mirror cabinet, 2 doors mirrored on both sides, 2 glass boards, incl. switch/ socket, LED lighting FLL90, 6000 K, 17,0 W, 1751 lumen, EEC E</i>					Dieses Produkt enthält eine Lichtquelle der Energieeffizienzklasse E	









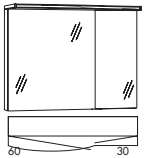

	Aufbauleuchte/ <i>top light</i> Spiegelschrank, 2 beidseitig verspiegelte Türen, 2 Glaseinlegeböden, inkl. Schalter/Steckdose, <b>LED Aufbauleuchte FLS90</b> <b>2800-6500 K, 17,5 W, 1390 Lumen,</b> <b>EEK G, Helligkeit dimmbar</b>	90,0	68,2	17,6	<b>SSFGZ63</b>		<b>2376</b>
	<i>mirror cabinet, 2 doors mirrored on both sides, 2 glass boards, incl. switch/ socket, LED lighting FLS90, 2800-6500 K, 17,5 W, 1390 lumen, EEC G brightness dimmable</i>					Dieses Produkt enthält eine Lichtquelle der Energieeffizienzklasse G	

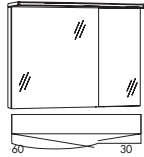
EEK/EEC=Energyeffizienzklasse/energy efficiency category

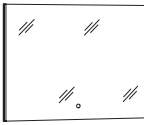
Leuchtmittel sind nicht austauschbar / illuminants are not interchangeable.

 Regalfarben unbedingt mit angeben, Übersicht siehe Seite 3. Please indicate shelf colours, overview see page 3.

# 3090cosmo »90 cm R Mineralmarmor/marble minerals«



Beschreibung Description	Maße in cm Dimensions in cm			Artikel-Nr. Article no.	Türanschlag Door stop	Identnummer ID number
	B/W	H	T/D			
<p>Acryloberboden/acryl top</p>  <p>Spiegelschrank, 2 beidseitig verspiegelte Türen, 2 Glaseinlegeböden, inkl. Schalter/Steckdose, <b>gerundeter Acryloberboden</b> mit LED-Beleuchtung, <b>6000 K</b>, 8,5 W 1020 Lumen, EEK F</p> <p><i>mirror cabinet, 2 doors mirrored on both sides, 2 glass boards, incl. switch/socket, <b>rounded acryl-top</b> with LED lighting, <b>6000 K</b>, 8,5 W, 1020 lumen, EEC F</i></p>	90,0	68,2	17,6	<b>SSAOS63</b>		<b>2001</b>
<p>Dieses Produkt enthält eine Lichtquelle der Energieeffizienzklasse F</p>						
<p>Acryloberboden/acryl top</p>  <p>Spiegelschrank, 2 beidseitig verspiegelte Türen, 2 Glaseinlegeböden, inkl. Schalter/Steckdose, <b>gerundeter Acryloberboden</b> mit LED-Beleuchtung, <b>2800-6500 K</b>, 17,0 W, 2550 Lumen, EEK F <b>Helligkeit dimmbar</b></p> <p><i>mirror cabinet, 2 doors mirrored on both sides, 2 glass boards, incl. switch/socket, <b>rounded acryl-top</b> with LED lighting, <b>2800-6500 K</b>, 17,0 W, 2550 lumen, EEC F <b>brighness dimmable</b></i></p>	90,0	68,2	17,6	<b>SSAOZ63</b>		<b>2248</b>
<p>Dieses Produkt enthält eine Lichtquelle der Energieeffizienzklasse F</p>						
 <p>Spiegelpaneel, Sensorschalter, seitliche LED-Beleuchtung 6000 K, 2x 6,3 W, 2x 660 Lumen, EEK F <b>Helligkeit dimmbar</b></p> <p><i>mirror panel, sensor switch, lateral LED-lighting 6000 K, 2x 6,3 W, 2x 660 lumen, EEC F <b>brighness dimmable</b></i></p>	90,0	68,2	2,8	<b>SPBSA9</b>	 	<b>1200</b>
<p>Dieses Produkt enthält eine Lichtquelle der Energieeffizienzklasse F</p>						
 <p>LED-Aufbauleuchte für Spiegelpaneel mit LED-Mini-Stecker, 6000 K, 12,5 W, 1566 Lumen, EEK E <b>Helligkeit dimmbar</b></p> <p><i>LED-lighting for mirror panel with LED-mini-plug, 6000 K, 12,5 W, 1566 lumen, EEC E <b>brighness dimmable</b></i></p>	90,0	2,4	10,0	<b>AWP90</b>	 	<b>392</b>
<p>Dieses Produkt enthält eine Lichtquelle der Energieeffizienzklasse E</p>						

EEK/EEC=Energieeffizienzklasse/energy efficiency category

Leuchtmittel sind nicht austauschbar / illuminants are not interchangeable.

# 3090cosmo »120 cm L Mineralmarmor/marble minerals«

Beschreibung Description	Maße in cm Dimensions in cm			Artikel-Nr. Article no.	Türanschlag Door stop	Identnummer ID number
	B/W	H	T/D			



	Mineralmarmor-Waschtisch inkl. Überlauf  <i>marble minerals washbasin incl. overflow</i>	120,4	2,0	41,5/ 49,5	<b>MWC120L</b> 	<b>1384</b>
--	---	-------	-----	---------------	---	-------------

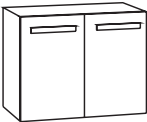

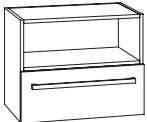
						PG2	PG3
	Waschtisch-Unterschrank 2 Auszüge  <i>washbasin base cabinet 2 extensions</i>	60,0	47,8	40,3/ 48,0	<b>WUAR62D</b>	<b>1500</b>	<b>1661</b>

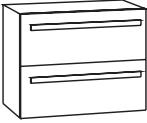
	Unterschrank 2 Türen, 1 Glaseinlegeboden  <i>base cabinet 1 door, 1 glass shelf</i>	60,0	47,8	40,3	<b>WU60D</b>	<b>739</b>	<b>876</b>
--	--	------	------	------	--------------	------------	------------

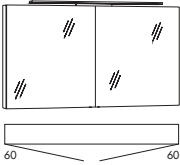
	Unterschrank 1 Einschubregal, 1 Auszug  <i>base cabinet 1 push in shelf, 1 extension</i>	60,0	47,8	40,3	<b>WUEA60D</b>	<b>1042</b>	<b>1200</b>
---	---	------	------	------	----------------	-------------	-------------

	Unterschrank 2 Auszüge  <i>base cabinet 2 extensions</i>	60,0	47,8	40,3	<b>WUA62D</b>	<b>1200</b>	<b>1362</b>
--	---	------	------	------	---------------	-------------	-------------

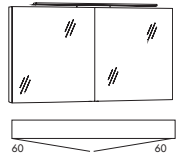
	<b>Aufbauleuchte/top light</b> Spiegelschrank, 2 beidseitig verspiegelte Türen, 4 Glaseinlegeböden, inkl. Schalter/Steckdose, <b>LED Aufbauleuchte FLL90</b> <b>6000 K, 17,0 W, 1751 Lumen, EEK E</b>  <i>mirror cabinet, 2 doors mirrored on both sides, 4 glass boards, incl. switch/ socket, <b>LED lighting FLL90, 6000 K,</b> <b>17,0 W, 1751 lumen, EEC E</b></i>	120,0	68,2	17,6	<b>SSFGS66</b> 	<b>2076</b>
					Dieses Produkt enthält eine Lichtquelle der Energieeffizienzklasse E	











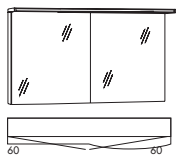

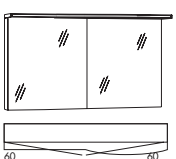

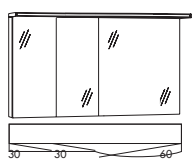

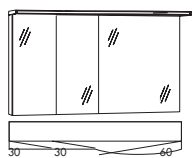
	<b>Aufbauleuchte/top light</b> Spiegelschrank, 2 beidseitig verspiegelte Türen, 4 Glaseinlegeböden, inkl. Schalter/Steckdose, <b>LED Aufbauleuchte FLS90</b> <b>2800-6500 K, 17,5 W, 1390 Lumen,</b> <b>EEK G, Helligkeit dimmbar</b>  <i>mirror cabinet, 2 doors mirrored on both sides, 4 glass boards, incl. switch/ socket, <b>LED lighting FLS90,</b> <b>2800-6500 K, 17,5 W, 1390 lumen,</b> <b>EEC G brightness dimmable</b></i>	120,0	68,2	17,6	<b>SSFGZ66</b> 	<b>2492</b>
					Dieses Produkt enthält eine Lichtquelle der Energieeffizienzklasse G	

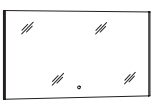
EEK/EEC=Energyeffizienzklasse/energy efficiency category

Leuchtmittel sind nicht austauschbar / illuminants are not interchangeable.

 Regalfarben unbedingt mit angeben, Übersicht siehe Seite 3. Please indicate shelf colours, overview see page 3.



# 3090cosmo »120 cm L Mineralmarmor/marble minerals«

Beschreibung Description	Maße in cm Dimensions in cm			Artikel-Nr. Article no.	Türanschlag Door stop	Identnummer ID number
	B/W	H	T/D			
<p>Acryloberboden/acryl top</p>  <p>Spiegelschrank, 2 beidseitig verspiegelte Türen, 4 Glaseinlegeböden, inkl. Schalter/Steckdose, <b>gerundeter Acryloberboden</b> mit LED-Beleuchtung, <b>6000 K</b>, 11,5 W 1380 Lumen, EEK F</p> <p><i>mirror cabinet, 2 doors mirrored on both sides, 4 glass boards, incl. switch/socket, <b>rounded acryl-top</b> with LED lighting, <b>6000 K</b>, 11,5 W, 1380 lumen, EEC F</i></p>	120,0	68,2	17,6	<b>SSAOS66L</b>	 <p>Dieses Produkt enthält eine Lichtquelle der Energieeffizienzklasse F</p>	<b>2112</b>
<p>Acryloberboden/acryl top</p>  <p>Spiegelschrank, 2 beidseitig verspiegelte Türen, 4 Glaseinlegeböden, inkl. Schalter/Steckdose, <b>gerundeter Acryloberboden</b> mit LED-Beleuchtung, <b>2800-6500 K</b>, 23,0 W, 3450 Lumen, EEK F <b>Helligkeit dimmbar</b></p> <p><i>mirror cabinet, 2 doors mirrored on both sides, 4 glass boards, incl. switch/socket, <b>rounded acryl-top</b> with LED lighting, <b>2800-6500 K</b>, 23,0 W, 3450 lumen, EEC F <b>brighness dimmable</b></i></p>	120,0	68,2	17,6	<b>SSAOZ66L</b>	 <p>Dieses Produkt enthält eine Lichtquelle der Energieeffizienzklasse F</p>	<b>2359</b>
<p>Acryloberboden/acryl top</p>  <p>Spiegelschrank, 3 beidseitig verspiegelte Türen, 4 Glaseinlegeböden, inkl. Schalter/Steckdose, <b>gerundeter Acryloberboden</b> mit LED-Beleuchtung, <b>6000 K</b>, 11,5 W 1380 Lumen, EEK F</p> <p><i>mirror cabinet, 3 doors mirrored on both sides, 4 glass boards, incl. switch/socket, <b>rounded acryl-top</b> with LED lighting, <b>6000 K</b>, 11,5 W, 1380 lumen, EEC F</i></p>	120,0	68,2	17,6	<b>SSAOS336</b>	 <p>Dieses Produkt enthält eine Lichtquelle der Energieeffizienzklasse F</p>	<b>2261</b>
<p>Acryloberboden/acryl top</p>  <p>Spiegelschrank, 3 beidseitig verspiegelte Türen, 4 Glaseinlegeböden, inkl. Schalter/Steckdose, <b>gerundeter Acryloberboden</b> mit LED-Beleuchtung, <b>2800-6500 K</b>, 23,0 W, 3450 Lumen, EEK F <b>Helligkeit dimmbar</b></p> <p><i>mirror cabinet, 3 doors mirrored on both sides, 4 glass boards, incl. switch/socket, <b>rounded acryl-top</b> with LED lighting, <b>2800-6500 K</b>, 23,0 W, 3450 lumen, EEC F <b>brighness dimmable</b></i></p>	120,0	68,2	17,6	<b>SSAOZ336</b>	 <p>Dieses Produkt enthält eine Lichtquelle der Energieeffizienzklasse F</p>	<b>2583</b>
 <p>Spiegelpaneel, Sensorschalter, seitliche LED-Beleuchtung 6000 K, 2x 6,3 W, 2x 660 Lumen, EEK F <b>Helligkeit dimmbar</b></p> <p><i>mirror panel, sensor switch, lateral LED-lighting 6000 K, 2x 6,3 W, 2x 660 lumen, EEC F <b>brighness dimmable</b></i></p>	120,0	68,2	2,8	<b>SPBSA12</b>	   <p>Dieses Produkt enthält eine Lichtquelle der Energieeffizienzklasse F</p>	<b>1292</b>
 <p>LED-Aufbauleuchte für Spiegelpaneel mit LED-Mini-Stecker, 6000 K, 17,3 W, 2160 Lumen, EEK E <b>Helligkeit dimmbar</b></p> <p><i>LED-lighting for mirror panel with LED-mini-plug, 6000 K, 17,3 W, 2160 lumen, EEC E <b>brighness dimmable</b></i></p>	120,0	2,4	10,0	<b>AWP120</b>	   <p>Dieses Produkt enthält eine Lichtquelle der Energieeffizienzklasse E</p>	<b>439</b>

EEK/EEC=Energieeffizienzklasse/energy efficiency category  
Leuchtmittel sind nicht austauschbar / illuminants are not interchangeable.

# 3090cosmo »120 cm R Mineralmarmor/marble minerals«

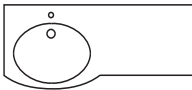
Beschreibung Description	Maße in cm Dimensions in cm			Artikel-Nr. Article no.	Türanschlag Door stop	Identnummer ID number
	B/W	H	T/D			



	Mineralmarmor-Waschtisch inkl. Überlauf  <i>marble minerals washbasin incl. overflow</i>	120,4	2,0	41,5/ 49,5	<b>MWC120R</b> 	<b>1384</b>
--	---	-------	-----	---------------	---	-------------

	Waschtisch-Unterschrank 2 Auszüge  <i>washbasin base cabinet 2 extensions</i>	60,0	47,8	40,3/ 48,0	<b>WUAR62D</b>	<b>1500</b>	<b>1661</b>
---	--	------	------	---------------	----------------	-------------	-------------

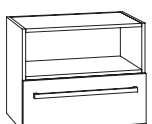

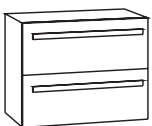
	Unterschrank 2 Türen, 1 Glaseinlegeboden  <i>base cabinet 1 door, 1 glass shelf</i>	60,0	47,8	40,3	<b>WU60D</b>	<b>739</b>	<b>876</b>
--	--	------	------	------	--------------	------------	------------

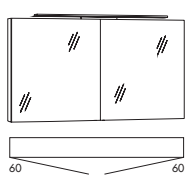
	Unterschrank 1 Einschubregal, 1 Auszug  <i>base cabinet 1 push in shelf, 1 extension</i>	60,0	47,8	40,3	<b>WUEA60D</b>	<b>1042</b>	<b>1200</b>
---	---	------	------	------	----------------	-------------	-------------

	Unterschrank 2 Auszüge  <i>base cabinet 2 extensions</i>	60,0	47,8	40,3	<b>WUA62D</b>	<b>1200</b>	<b>1362</b>
--	---	------	------	------	---------------	-------------	-------------

	<b>Aufbauleuchte/top light</b> Spiegelschrank, 2 beidseitig verspiegelte Türen, 4 Glaseinlegeböden, inkl. Schalter/Steckdose, <b>LED Aufbauleuchte FLL90</b> <b>6000 K, 17,0 W, 1751 Lumen, EEK E</b>  <i>mirror cabinet, 2 doors mirrored on both sides, 4 glass boards, incl. switch/ socket, <b>LED lighting FLL90, 6000 K,</b> 17,0 W, 1751 lumen, EEC E</i>	120,0	68,2	17,6	<b>SSFGS66</b> 	<b>2076</b>
--	--	-------	------	------	---	-------------

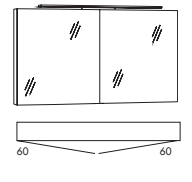
Dieses Produkt enthält eine  
Lichtquelle  
der Energieeffizienzklasse E

	<b>Aufbauleuchte/top light</b> Spiegelschrank, 2 beidseitig verspiegelte Türen, 4 Glaseinlegeböden, inkl. Schalter/Steckdose, <b>LED Aufbauleuchte FLS90</b> <b>2800-6500 K, 17,5 W, 1390 Lumen,</b> EEK G, <b>Helligkeit dimmbar</b>  <i>mirror cabinet, 2 doors mirrored on both sides, 4 glass boards, incl. switch/ socket, <b>LED lighting FLS90,</b> <b>2800-6500 K, 17,5 W, 1390 lumen,</b> EEC G <b>brighness dimmable</b></i>	120,0	68,2	17,6	<b>SSFGZ66</b> 	<b>2492</b>
--	---	-------	------	------	---	-------------











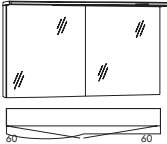

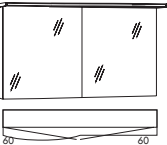

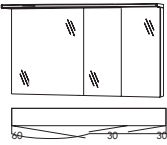

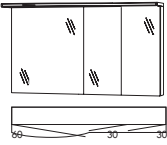
Dieses Produkt enthält eine  
Lichtquelle  
der Energieeffizienzklasse G

EEK/EEC=Energyeffizienzklasse/energy efficiency category

Leuchtmittel sind nicht austauschbar / illuminants are not interchangeable.

 Regalfarben unbedingt mit angeben, Übersicht siehe Seite 3. Please indicate shelf colours, overview see page 3.



# 3090cosmo »120 cm R Mineralmarmor/ marble minerals«

Beschreibung Description	Maße in cm Dimensions in cm			Artikel-Nr. Article no.	Türanschlag Door stop	Identnummer ID number
	B/W	H	T/D			
<p>Acryloberboden/acryl top</p>  <p>Spiegelschrank, 2 beidseitig verspiegelte Türen, 4 Glaseinlegeböden, inkl. Schalter/Steckdose, <b>gerundeter Acryloberboden</b> mit LED-Beleuchtung, <b>6000 K</b>, 11,5 W 1380 Lumen, EEK F</p> <p><i>mirror cabinet, 2 doors mirrored on both sides, 4 glass boards, incl. switch/socket, <b>rounded acryl-top</b> with LED lighting, <b>6000 K</b>, 11,5 W, 1380 lumen, EEC F</i></p>	120,0	68,2	17,6	<p><b>SSAOS66R</b></p>  <p>Dieses Produkt enthält eine Lichtquelle der Energieeffizienzklasse F</p>		<b>2112</b>
<p>Acryloberboden/acryl top</p>  <p>Spiegelschrank, 2 beidseitig verspiegelte Türen, 4 Glaseinlegeböden, inkl. Schalter/Steckdose, <b>gerundeter Acryloberboden</b> mit LED-Beleuchtung, <b>2800-6500 K</b>, 23,0 W, 3450 Lumen, EEK F <b>Helligkeit dimmbar</b></p> <p><i>mirror cabinet, 2 doors mirrored on both sides, 4 glass boards, incl. switch/socket, <b>rounded acryl-top</b> with LED lighting, <b>2800-6500 K</b>, 23,0 W, 3450 lumen, EEC F <b>brighness dimmable</b></i></p>	120,0	68,2	17,6	<p><b>SSAOZ66R</b></p>  <p>Dieses Produkt enthält eine Lichtquelle der Energieeffizienzklasse F</p>		<b>2359</b>
<p>Acryloberboden/acryl top</p>  <p>Spiegelschrank, 3 beidseitig verspiegelte Türen, 4 Glaseinlegeböden, inkl. Schalter/Steckdose, <b>gerundeter Acryloberboden</b> mit LED-Beleuchtung, <b>6000 K</b>, 11,5 W 1380 Lumen, EEK F</p> <p><i>mirror cabinet, 3 doors mirrored on both sides, 4 glass boards, incl. switch/socket, <b>rounded acryl-top</b> with LED lighting, <b>6000 K</b>, 11,5 W, 1380 lumen, EEC F</i></p>	120,0	68,2	17,6	<p><b>SSAOS633</b></p>  <p>Dieses Produkt enthält eine Lichtquelle der Energieeffizienzklasse F</p>		<b>2261</b>
<p>Acryloberboden/acryl top</p>  <p>Spiegelschrank, 3 beidseitig verspiegelte Türen, 4 Glaseinlegeböden, inkl. Schalter/Steckdose, <b>gerundeter Acryloberboden</b> mit LED-Beleuchtung, <b>2800-6500 K</b>, 23,0 W, 3450 Lumen, EEK F <b>Helligkeit dimmbar</b></p> <p><i>mirror cabinet, 3 doors mirrored on both sides, 4 glass boards, incl. switch/socket, <b>rounded acryl-top</b> with LED lighting, <b>2800-6500 K</b>, 23,0 W, 3450 lumen, EEC F <b>brighness dimmable</b></i></p>	120,0	68,2	17,6	<p><b>SSAOZ633</b></p>  <p>Dieses Produkt enthält eine Lichtquelle der Energieeffizienzklasse F</p>		<b>2583</b>
 <p>Spiegelpaneel, Sensorschalter, seitliche LED-Beleuchtung 6000 K, 2x 6,3 W, 2x 660 Lumen, EEK F <b>Helligkeit dimmbar</b></p> <p><i>mirror panel, sensor switch, lateral LED-lighting 6000 K, 2x 6,3 W, 2x 660 lumen, EEC F <b>brighness dimmable</b></i></p>	120,0	68,2	2,8	<p><b>SPBSA12</b></p>   <p>Dieses Produkt enthält eine Lichtquelle der Energieeffizienzklasse F</p>		<b>1292</b>
 <p>LED-Aufbauleuchte für Spiegelpaneel mit LED-Mini-Stecker, 6000 K, 17,3 W, 2160 Lumen, EEK E <b>Helligkeit dimmbar</b></p> <p><i>LED-lighting for mirror panel with LED-mini-plug, 6000 K, 17,3 W, 2160 lumen, EEC E <b>brighness dimmable</b></i></p>	120,0	2,4	10,0	<p><b>AWP120</b></p>   <p>Dieses Produkt enthält eine Lichtquelle der Energieeffizienzklasse E</p>		<b>439</b>

EEK/EEC=Energieeffizienzklasse/energy efficiency category  
Leuchtmittel sind nicht austauschbar / illuminants are not interchangeable.

# 3090cosmo »120 cm M Mineralmarmor/marble minerals«

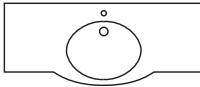
Beschreibung Description	Maße in cm Dimensions in cm			Artikel-Nr. Article no.	Türanschlag Door stop	Identnummer ID number
	B/W	H	T/D			

	Mineralmarmor-Waschtisch inkl. Überlauf  <i>marble minerals washbasin incl. overflow</i>	120,4	2,0	41,5/ 49,5	<b>MWC120M</b> 	<b>1384</b>
--	---	-------	-----	---------------	---	-------------

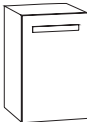

						PG2	PG3
	Waschtisch-Unterschrank 2 Auszüge  <i>washbasin base cabinet 2 extensions</i>	60,0	47,8	40,3/ 48,0	<b>WUAR62D</b>	<b>1500</b>	<b>1661</b>

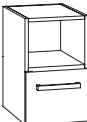
	Unterschrank 1 Tür, 1 Glaseinlegeboden  <i>base cabinet 1 door, 1 glass shelf</i>	30,0	47,8	40,3	<b>WU30DL</b> <b>WU30DR</b>	Links/left Rechts/right	<b>486</b>	<b>648</b>
---	--	------	------	------	--------------------------------	----------------------------	------------	------------

	Unterschrank 1 Einschubregal, 1 Auszug  <i>base cabinet 1 push in shelf, 1 extension</i>	30,0	47,8	40,3	<b>WUEA30D</b>		<b>811</b>	<b>972</b>
--	---	------	------	------	----------------	--	------------	------------

	Unterschrank 2 Auszüge  <i>base cabinet 2 extensions</i>	30,0	47,8	40,3	<b>WUA32D</b>		<b>900</b>	<b>1038</b>
---	---	------	------	------	---------------	--	------------	-------------

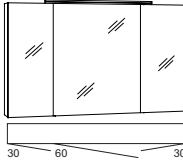
	<b>Aufbauleuchte/top light</b> Spiegelschrank, 3 beidseitig verspiegelte Türen, 4 Glaseinlegeböden, inkl. Schalter/Steckdose, <b>LED Aufbauleuchte FLL90 6000 K</b> , 17,0 W, 1751 Lumen, EEK E  <i>mirror cabinet, 3 doors mirrored on both sides, 4 glass boards, incl. switch/socket, LED lighting FLL90, 6000 K, 17,0 W, 1751 lumen, EEC E</i>	120,0	68,2	17,6	<b>SSFGS363</b> 		<b>2307</b>
						Dieses Produkt enthält eine Lichtquelle der Energieeffizienzklasse E	

	<b>Aufbauleuchte/top light</b> Spiegelschrank, 3 beidseitig verspiegelte Türen, 4 Glaseinlegeböden, inkl. Schalter/Steckdose, <b>LED Aufbauleuchte FLS90 2800-6500 K</b> , 17,5 W, 1390 Lumen, EEK G, Helligkeit dimmbar  <i>mirror cabinet, 3 doors mirrored on both sides, 4 glass boards, incl. switch/socket, LED lighting FLS90, 2800-6500 K, 17,5 W, 1390 lumen, EEC G brightness dimmable</i>	120,0	68,2	17,6	<b>SSFGZ363</b> 		<b>2722</b>
						Dieses Produkt enthält eine Lichtquelle der Energieeffizienzklasse G	









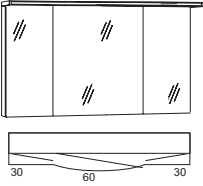

EEK/EEC=Energyeffizienzklasse/energy efficiency category

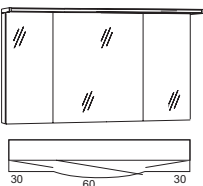
Leuchtmittel sind nicht austauschbar / illuminants are not interchangeable.

 Regalfarben unbedingt mit angeben, Übersicht siehe Seite 3. Please indicate shelf colours, overview see page 3.



Beschreibung Description	Maße in cm Dimensions in cm			Artikel-Nr. Article no.	Türanschlag Door stop	Identnummer ID number
	B/W	H	T/D			



<p>Acryloberboden/acryl top</p> 	<p>Spiegelschrank, 3 beidseitig verspiegelte Türen, 4 Glaseinlegeböden, inkl. Schalter/Steckdose, <b>gerundeter Acryloberboden</b> mit LED-Beleuchtung, <b>6000 K</b>, 11,5 W, 1380 Lumen, EEK F</p> <p><i>mirror cabinet, 3 doors mirrored on both sides, 4 glass boards, incl. switch/socket, <b>rounded acryl-top</b> with LED lighting, <b>6000 K</b>, 11,5 W, 1380 lumen, EEC F</i></p>	120,0	68,2	17,6	<p><b>SSAOS363</b></p>  <p>Dieses Produkt enthält eine Lichtquelle der Energieeffizienzklasse F</p>	2261
<p>Acryloberboden/acryl top</p> 	<p>Spiegelschrank, 3 beidseitig verspiegelte Türen, 4 Glaseinlegeböden, inkl. Schalter/Steckdose, <b>gerundeter Acryloberboden</b> mit LED-Beleuchtung, <b>2800-6500 K</b>, 23,0 W, 3450 Lumen, EEK F <b>Helligkeit dimmbar</b></p> <p><i>mirror cabinet, 3 doors mirrored on both sides, 4 glass boards, incl. switch/socket, <b>rounded acryl-top</b> with LED lighting, <b>2800-6500 K</b>, 23,0 W, 3450 lumen, EEC F <b>brighness dimmable</b></i></p>	120,0	68,2	17,6	<p><b>SSAOZ363</b></p>  <p>Dieses Produkt enthält eine Lichtquelle der Energieeffizienzklasse F</p>	2583
	<p>Spiegelpaneel, Sensorschalter, seitliche LED-Beleuchtung 6000 K, 2x 6,3 W, 2x 660 Lumen, EEK F <b>Helligkeit dimmbar</b></p> <p><i>mirror panel, sensor switch, lateral LED-lighting 6000 K, 2x 6,3 W, 2x 660 lumen, EEC F <b>brighness dimmable</b></i></p>	120,0	68,2	2,8	<p><b>SPBSA12</b></p>   <p>Dieses Produkt enthält eine Lichtquelle der Energieeffizienzklasse F</p>	1292
	<p>LED-Aufbauleuchte für Spiegelpaneel mit LED-Mini-Stecker, 6000 K, 17,3 W, 2160 Lumen, EEK E <b>Helligkeit dimmbar</b></p> <p><i>LED-lighting for mirror panel with LED-mini-plug, 6000 K, 17,3 W, 2160 lumen, EEC E <b>brighness dimmable</b></i></p>	120,0	2,4	10,0	<p><b>AWP120</b></p>   <p>Dieses Produkt enthält eine Lichtquelle der Energieeffizienzklasse E</p>	439

EEK/EEC=Energieeffizienzklasse/energy efficiency category

Leuchtmittel sind nicht austauschbar / illuminants are not interchangeable.

# 3090cosmo »150 cm Mineralmarmor/marble minerals«

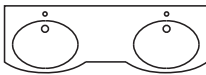
Beschreibung Description	Maße in cm Dimensions in cm			Artikel-Nr. Article no.	Türanschlag Door stop	Identnummer ID number	
	B/W	H	T/D				



	Mineralmarmor-Doppel-Waschtisch inkl. Überlauf	150,4	2,0	41,5/ 49,5	<b>MWC150D</b>		<b>1799</b>
	<i>marble minerals double washbasin incl. overflow</i>						

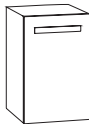

						PG2	PG3
	Waschtisch-Unterschrank 2 Auszüge	60,0	47,8	40,3/ 48,0	<b>WUAR62D</b>	<b>1500</b>	<b>1661</b>
	<i>washbasin base cabinet 2 extensions</i>						

	Unterschrank 1 Tür, 1 Glaseinlegeboden	30,0	47,8	40,3	<b>WU30DL</b> <b>WU30DR</b>	Links/left Rechts/right	<b>486</b>	<b>648</b>
	<i>base cabinet 1 door, 1 glass shelf</i>							

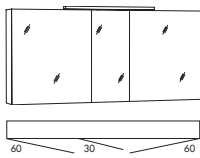
	Unterschrank 1 Einschubregal, 1 Auszug	30,0	47,8	40,3	<b>WUEA30D</b>		<b>811</b>	<b>972</b>
	<i>base cabinet 1 push in shelf, 1 extension</i>							

	Unterschrank 2 Auszüge	30,0	47,8	40,3	<b>WUA32D</b>		<b>900</b>	<b>1038</b>
	<i>base cabinet 2 extensions</i>							

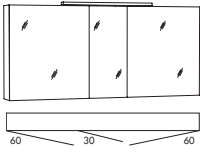
	Aufbauleuchte/top light Spiegelschrank, 3 beidseitig verspiegelte Türen, 4 Glaseinlegeböden, inkl. Schalter/Steckdose, <b>LED Aufbauleuchte FLL90</b> <b>6000 K</b> , 17,0 W, 1751 Lumen, EEK E	150,0	68,2	17,6	<b>SSFGS636</b>		<b>2514</b>
	<i>mirror cabinet, 3 doors mirrored on both sides, 4 glass boards, incl. switch/ socket, <b>LED lighting FLL90, 6000 K</b>, 17,0 W, 1751 lumen, EEC E</i>					Dieses Produkt enthält eine Lichtquelle der Energieeffizienzklasse E	

	Aufbauleuchte/top light Spiegelschrank, 3 beidseitig verspiegelte Türen, 4 Glaseinlegeböden, inkl. Schalter/Steckdose, <b>LED Aufbauleuchte FLS90</b> <b>2800-6500 K</b> , 17,5 W, 1390 Lumen, EEK G, Helligkeit dimmbar	150,0	68,2	17,6	<b>SSFGS636</b>		<b>2929</b>
	<i>mirror cabinet, 3 doors mirrored on both sides, 4 glass boards, incl. switch/ socket, <b>LED lighting FLS90</b>, <b>2800-6500 K</b>, 17,5 W, 1390 lumen, EEC G <b>brighness dimmable</b></i>					Dieses Produkt enthält eine Lichtquelle der Energieeffizienzklasse G	





EEK/EEC=Energieeffizienzklasse/energy efficiency category

Leuchtmittel sind nicht austauschbar / illuminants are not interchangeable.

 Regalfarben unbedingt mit angeben, Übersicht siehe Seite 3. Please indicate shelf colours, overview see page 3.

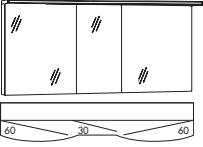
# 3090cosmo »150 cm Mineralmarmor/*marble minerals*«

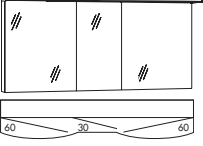
Beschreibung Description	Maße in cm Dimensions in cm			Artikel-Nr. Article no.	Türanschlag Door stop	Identnummer ID number
	B/W	H	T/D			

<p>Acryloberboden/acryl top</p> 	<p>Spiegelschrank, 3 beidseitig verspiegelte Türen, 6 Glaseinlegeböden, inkl. Schalter/Steckdose, <b>gerundeter Acryloberboden</b> mit LED-Beleuchtung, <b>6000 K</b>, 14,5 W 1740 Lumen, EEK F</p> <p><i>mirror cabinet, 3 doors mirrored on both sides, 6 glass boards, incl. switch/socket, <b>rounded acryl-top</b> with LED lighting, <b>6000 K</b>, 14,5 W, 1740 lumen, EEC F</i></p>	<p>150,0 68,2 17,6</p>	<p><b>SSAOS636</b></p>  <p>Dieses Produkt enthält eine Lichtquelle der Energieeffizienzklasse F</p>	<p><b>2687</b></p>
<p>Acryloberboden/acryl top</p> 	<p>Spiegelschrank, 3 beidseitig verspiegelte Türen, 6 Glaseinlegeböden, inkl. Schalter/Steckdose, <b>gerundeter Acryloberboden</b> mit LED-Beleuchtung, <b>2800-6500 K</b>, 29,0 W, 4350 Lumen, EEK F <b>Helligkeit dimmbar</b></p> <p><i>mirror cabinet, 3 doors mirrored on both sides, 6 glass boards, incl. switch/socket, <b>rounded acryl-top</b> with LED lighting, <b>2800-6500 K</b>, 29,0 W, 4350 lumen, EEC F <b>brighness dimmable</b></i></p>	<p>150,0 68,2 17,6</p>	<p><b>SSAOZ636</b></p>  <p>Dieses Produkt enthält eine Lichtquelle der Energieeffizienzklasse F</p>	<p><b>2907</b></p>

EEK/EEC=Energieeffizienzklasse/energy efficiency category

Leuchtmittel sind nicht austauschbar / illuminants are not interchangeable.

# 3090cosmo »Spiegelpaneele und Zubehör/mirror panels and accessoires«

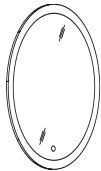
Beschreibung Description	Maße in cm Dimensions in cm			Artikel-Nr. Article no.	Türanschlag Door stop	Identnummer ID number
	B/W	H	T/D			
 <p>Spiegelpaneel, Sensorschalter, satiniert, LED Beleuchtung, 4000 K, 17,3 W, 2415 Lumen, EEK G <b>Helligkeit dimmbar</b></p> <p><i>mirror panel, sensor switch, satined, LED-lighting, 4000 K, 17,3 W, 2415 lumen, EEC G</i> <b>brighness dimmable</b></p>	55,0	78,0	2,8	<b>SPE55</b>   Dieses Produkt enthält eine Lichtquelle der Energieeffizienzklasse G	1131	
 <p>Spiegelpaneel, Sensorschalter, satiniert, LED Beleuchtung, 4000 K, 13,5 W, 1890 Lumen, EEK G <b>Helligkeit dimmbar</b></p> <p><i>mirror panel, sensor switch, satined, LED-lighting, 4000 K, 13,5 W, 1890 lumen, EEC G</i> <b>brighness dimmable</b></p>	55,0	55,0	2,8	<b>SPK55</b>   Dieses Produkt enthält eine Lichtquelle der Energieeffizienzklasse G	992	
 <p>Spiegelpaneel, Sensorschalter, satiniert, LED Beleuchtung, 4000 K, 20,8 W, 2905 Lumen, EEK G <b>Helligkeit dimmbar</b></p> <p><i>mirror panel, sensor switch, satined, LED-lighting, 4000 K, 20,8 W, 2905 lumen, EEC G</i> <b>brighness dimmable</b></p>	78,0	78,0	2,8	<b>SPK78</b>   Dieses Produkt enthält eine Lichtquelle der Energieeffizienzklasse G	1292	
 <p>Schubkasteneinsatz (Kunststoff) für oberen Auszug vom WT-Unterschrank</p> <p><i>drawer insert part (plastic) for top drawer from base cabinet</i></p>	36,1	4,3	34,0	<b>SCMBEG3</b>	69	
 <p>Steckdose/Powerbox für Spiegelschränke Ausführung <b>Schweiz</b> IP44 mit USB-C Stecker</p> <p><i>Power socket for mirror cabinets Switzerland type IP44 with USB-C plug</i></p>				<b>Mehrpreis extra charge</b>	138	
 <p>Steckdose/Powerbox für Spiegelschränke Ausführung <b>Frankreich</b> mit USB-C Stecker</p> <p><i>Power socket for mirror cabinets France type with USB-C plug</i></p>				<b>Mehrpreis extra charge</b>	138	

EEK/EEC=Energieeffizienzklasse/energy efficiency category

Leuchtmittel sind nicht austauschbar / illuminants are not interchangeable.

**i** Weiteres Zubehör finden Sie im Register 3970 und Beistellschränke im Register 3990.  
**Further accessoires can be found in register 3970 and side cabinets in register 3990.**



# 3100scala





# »3100scala«

## Piktogramme/pictograms



Mineralmarmor Waschtisch  
Marble minerals washbasin



LED Lichtfarbe kalt  
LED colour temperature cold



LED mit Bewegungssensor  
LED with motion sensor



LED Lichtfarbe warm  
LED colour temperature warm



LED mit Sensorschalter,  
Helligkeit dimmbar  
LED with sensor switch,  
brightness dimmable

## Mineralmarmor Waschtisch Marble minerals washbasin

≈ Beckenmaße in cm (BxHxT)  
basin dimensions in cm (WxHxD)

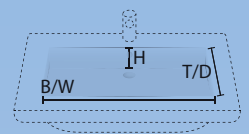

SCMW90 | 87,5x12x33,3 cm  
SCMWL90 | 87,5x12x33,3 cm\*



SCMW120 | 87,5x12x33,3 cm  
SCMWL120 | 87,5x12x33,3 cm\*

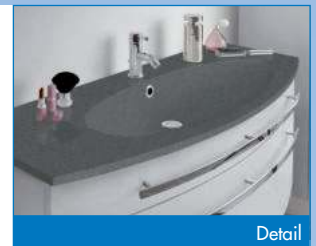

Detail



\* (L) mit LED-Beleuchtung  
(L) with LED lighting

## Mineralmarmor Glanz/gloss marble minerals

PG1



**Weiß Alpin Glanz**  
Gloss Alpine White  
SC69

Bei granitfarbigen Waschtischen kann es zu Farbabweichungen kommen, da der Gelcoat die Farbgebung maßgeblich beeinflusst und sich im Laufe der Zeit die Farbe durch Lichteinflüsse (Sonneneinstrahlung) verändern kann.  
Because the gelcoat influences the shade by effect of light (shafts of sunlight) the granit-coloured washbasins can vary in colour.

PG2



**Granit Weiß Glimmer**  
White Granite Glimmer  
SC74



**Granit Grau Glimmer**  
Grey Granite Glimmer  
SC73

## Schränke/cabinets 3100scala

### Frontfarben/front colours

#### MDF-foliiert/MDF-coated

449



**Kastanie Graphit Nachbildung**  
Graphite Chestnut Finish  
SCC\_

273



**Eiche Struktur Natur Nachbildung**  
Oak Structure Nature Finish  
SCM\_

235



**Eiche Struktur Weiß Nachbildung** NEW  
Oak Structure White Finish  
SCL\_

226



**Eiche Struktur Braun Nachbildung** NEW  
Oak Structure Brown Finish  
SCH\_

952



**Rot Glanz** NEW  
Gloss Red  
SCR\_

961



**Weiß Glanz**  
Gloss White  
SCG\_

438



**Anthrazit Glanz**  
Gloss Anthracite  
SCF\_

### Korpusfarben/basic shell colours

#### PG 2 Dickkante/thick edge

490



**Kastanie Graphit Nachbildung**  
Graphite Chestnut Finish  
C/SC45

473



**Eiche Struktur Natur Nachbildung**  
Oak Structure Nature Finish  
M/SC55

435



**Eiche Struktur Weiß Nachbildung** NEW  
Oak Structure White Finish  
L/SC40

426



**Eiche Struktur Braun Nachbildung** NEW  
Oak Structure Brown Finish  
H/SC70

#### PG 3 MDF-foliiert/MDF-coated

042



**Weiß Glanz Folie**  
Gloss White  
G/SC50

438



**Anthrazit Glanz Folie**  
Gloss Anthracite  
F/SC30



# »3100scala«

## Griffe/handles



**Chrom Glanz**  
Gloss Chrome

Griffnummer/handlenumber: 135/136/137/138  
⌀-⌀ 382 mm/128 mm/384 mm/96 mm

⌀-⌀ = Bohrabstand/hole spacing

Die Angabe einer Griffnummer ist ausreichend. Die Griffe werden passend zur jeweiligen Schrankbreite beigelegt.  
The indication of one handle number is sufficient. The handles are supplied to match the respective cabinet width.

## Beleuchtung / lighting



**Acryloberboden LED**  
Acrylic top LED



**Seitlich und oben LED Beleuchtung**  
lateral and top LED lighting



**Oberboden mit 2 LED Streifen**  
Top with 2 LED stripes



**Aufbauleuchte LED**  
Top light LED

**Lichtfarbe Tageslicht (Kalt)**











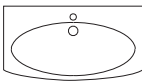

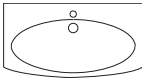
Luminous colour natural light (cold)

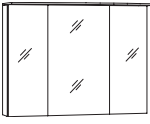

AWP90,  
AWP120

Die Steckdose / Powerbox für Spiegelschränke ist auch in Ausführung für die Schweiz / Frankreich erhältlich. Bitte Mehrpreis beachten (siehe Seite 8).  
The power socket for mirror cabinets is also available for Switzerland / France. Please note extra charge (see page 8).

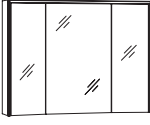
# 3100scala »90 cm Mineralmarmor/marble minerals«









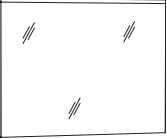

Beschreibung Description	Maße in cm Dimensions in cm			Artikel-Nr. Article no.	Türanschlag Door stop	Identnummer ID number	
	B/W	H	T/D			PG1 Weiß alpin/glass alpine	PG2 Granit/granite
 <p>Mineralmarmor-Waschtisch inkl. Überlauf <i>marble minerals washbasin incl. overflow</i></p>	90,4	2,0	41,3/ 48,0	SCMW90 		1085	1476
 <p>Mineralmarmor-Waschtisch inkl. Überlauf <b>mit LED-Beleuchtung und Bewegungs- sensor, 6000 K, 7,2 W, 864 Lumen, EEK E</b> <i>marble minerals washbasin incl. overflow with LED-lighting and motion sensor 6000 K, 7,2 W, 864 lumen, EEC E</i></p>	90,4	3,4	41,3/ 48,0	SCMWL90    Dieses Produkt enthält eine Lichtquelle der Energieeffizienzklasse E		1591	1984
						PG2	PG3
 <p>Waschtisch-Unterschrank 1 Schubkasten inkl. Kosmetikeinsatz 1 Auszug <i>washbasin base cabinet 1 drawer incl. kosmetik insert p., 1 extension</i></p>	90,0	47,8	40,3/ 47,0	SCWU92		1846	1984
 <p>Waschtisch-Unterschrank 2 Auszüge <i>washbasin base cabinet 2 extensions</i></p>	90,0	47,8 	40,3/ 47,0	SCUA92		1684	1892
<p>Acryloberboden/acryl top</p>  <p>Spiegelschrank, 3 Spiegeltüren, 6 Glaseinlegeböden, inkl. Schalter/ Steckdose, <b>gerundeter Acryloberboden</b> mit LED-Beleuchtung, 6000 K, 8,5 W 876 Lumen, EEK E <i>mirror cabinet, 3 mirror doors 6 glass shelves, incl. switch/socket, rounded acryl-top with LED lighting, 6000 K, 8,5 W, 876 lumen, EEC E</i></p>	90,0	68,2 	17,6	SAOE9 		1453	
 <p>Spiegelschrank, 3 Spiegeltüren - davon 2 trapezförmig angeordnet, 6 Glasein- legeböden, inkl. Schalter/Steckdose, <b>seitlich und oben LED-Beleuchtung</b>, 6000 K, 17,9 W, 960 Lumen, EEK E <i>mirror cabinet, 3 mirror doors - 2 of them are arranged in a trapeze, 6 glass shelves, incl. switch/socket, lateral and top LED lighting, 6000 K, 17,9 W, 960 lumen, EEC E</i></p>	90,0	68,2	17,6	SDU9 		2307	

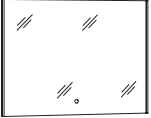
EEK/EEC=Energieeffizienzklasse/energy efficiency category

Leuchtmittel sind nicht austauschbar / illuminants are not interchangeable.









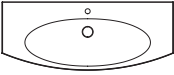

# 3100scala »90 cm Mineralmarmor/marble minerals«

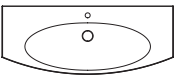
Beschreibung Description	Maße in cm Dimensions in cm			Artikel-Nr. Article no.	Türanschlag Door stop	Identnummer ID number
	B/W	H	T/D			

	<p>Spiegelpaneel Oberboden mit 2 LED-Streifen inkl. Schalter, 6000 K, 13,5 W, 504 Lumen, EEK G <b>Bitte L oder R für die seil. Position des Schalters angeben.</b></p> <p><i>mirror panel top with 2 LED stripes, incl. switch, 6000 K, 13,5 W, 504 lumen, EEC G <b>Please indicate L or R for the switch pos.</b></i></p>	90,0	68,2/ 70,1	3,0/ 10,0	<p><b>SCSPL90L/R</b></p>  <p>Dieses Produkt enthält eine Lichtquelle der Energieeffizienzklasse G</p>	946
	<p>Spiegelpaneel, Sensorschalter, seitliche LED-Beleuchtung 6000 K, 2x 6,3 W, 2x 660 Lumen, EEK F <b>Helligkeit dimmbar</b></p> <p><i>mirror panel, sensor switch, lateral LED-lighting 6000 K, 2x 6,3 W, 2x 660 lumen, EEC F <b>brighthness dimmable</b></i></p>	90,0	68,2	2,8	<p><b>SPBSA9</b></p>    <p>Dieses Produkt enthält eine Lichtquelle der Energieeffizienzklasse F</p>	1200
	<p>LED-Aufbauleuchte für Spiegelpaneel mit LED-Mini-Stecker, 6000 K, 12,5 W, 1566 Lumen, EEK E <b>Helligkeit dimmbar</b></p> <p><i>LED-lighting for mirror panel with LED-mini-plug, 6000 K, 12,5 W, 1566 lumen, EEC E <b>brighthness dimmable</b></i></p>	90,0	2,4	10,0	<p><b>AWP90</b></p>    <p>Dieses Produkt enthält eine Lichtquelle der Energieeffizienzklasse E</p>	392

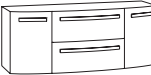
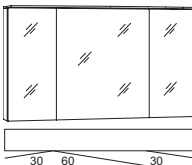
EEK/EEC=Energieeffizienzklasse/energy efficiency category  
Leuchtmittel sind nicht austauschbar / illuminants are not interchangeable.

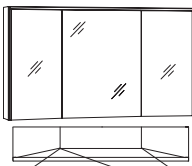







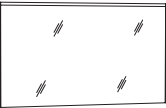

# 3100scala »120 cm Mineralmarmor/marble minerals«

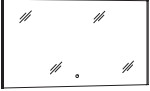
Beschreibung Description	Maße in cm Dimensions in cm			Artikel-Nr. Article no.	Türanschlag Door stop	Identnummer ID number	
	B/W	H	T/D			PG1 Weiß alpin/gloss alpine	PG2 Granit/granite
 <p>Mineralmarmor-Waschtisch inkl. Überlauf <i>marble minerals washbasin incl. overflow</i></p>	120,4	2,0	36,0/ 48,0	SCMW120		1223	1615
 <p>Mineralmarmor-Waschtisch inkl. Überlauf <b>mit LED-Beleuchtung und Bewegungs- sensor, 6000 K, 9,6 W, 1152 Lumen, EEK E</b> <i>marble minerals washbasin incl. overflow with LED-lighting and motion sensor 6000 K, 9,6 W, 1152 lumen, EEC E</i></p>	120,4	3,4	36,0/ 48,0	SCMWL120	  	1730	2123
 <p>Waschtisch-Unterschrank, 1 Schub- kasten inkl. Kosmetikeinsatz, 1 Auszug <i>washbasin base cabinet, 1 drawer incl. kosmetik insert p., 1 extension</i></p>	120,0	47,8	35,1/ 47,0	SCWU122		2307	2492
 <p>Waschtisch-Unterschrank 2 Türen, 2 Auszüge mittig <i>washbasin base cabinet, 2 doors, 2 extension in the middle</i></p>	120,0	47,8	35,1/ 47,0	SCUA122		2423	2583
<p>Acryloberboden/acryl top</p>  <p>Spiegelschrank, 3 Spiegeltüren, 6 Glaseinlegeböden, inkl. Schalter/ Steckdose, <b>gerundeter Acryloberboden</b> mit LED-Beleuchtung, 6000 K, 11,5 W 1380 Lumen, EEK F <i>mirror cabinet, 3 mirror doors 6 glass shelves, incl. switch/socket, rounded acryl-top with LED lighting, 6000 K, 11,5 W, 1380 lumen, EEC F</i></p>	120,0	68,2	17,6	SAOE12	 		1661
 <p>Spiegelschrank, 3 Spiegeltüren - davon 2 trapezförmig angeordnet, 6 Glasein- legeböden, inkl. Schalter/Steckdose, <b>seitlich und oben LED-Beleuchtung</b>, 6000 K, 20,3 W, 960 Lumen, EEK E <i>mirror cabinet, 3 mirror doors - 2 of them are arranged in a trapeze, 6 glass shelves, incl. switch/socket, lateral and top LED lighting, 6000 K, 20,3 W, 960 lumen, EEC E</i></p>	120,0	68,2	17,6	SDU12			2492

EEK/EEC=Energieeffizienzklasse/energy efficiency category









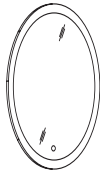

Leuchtmittel sind nicht austauschbar / illuminants are not interchangeable.

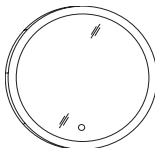
Beschreibung <i>Description</i>	Maße in cm <i>Dimensions in cm</i>			Artikel-Nr. <i>Article no.</i>	Türanschlag <i>Door stop</i>	Identnummer <i>ID number</i>
	B/W	H	T/D			

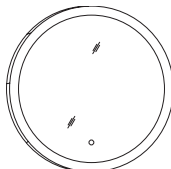
	<p>Spiegelpaneel Oberboden mit 2 LED-Streifen inkl. Schalter, 6000 K, 19,2 W, 720 Lumen, EEK G <b>Bitte L oder R für die seil. Position des Schalters angeben.</b></p> <p><i>mirror panel top with 2 LED stripes, incl. switch, 6000 K, 19,2 W, 720 lumen, EEC G Please indicate L or R for the switch pos.</i></p>	<p>120,0 68,2/ 3,0/ 70,1 10,0</p>	<p><b>SCSPL120L/R</b></p> 	<p><b>1107</b></p>
	<p>Spiegelpaneel, Sensorschalter, seitliche LED-Beleuchtung 6000 K, 2x 6,3 W, 2x 660 Lumen, EEK F <b>Helligkeit dimmbar</b></p> <p><i>mirror panel, sensor switch, lateral LED-lighting 6000 K, 2x 6,3 W, 2x 660 lumen, EEC F brightness dimmable</i></p>	<p>120,0 68,2 2,8</p> 	<p><b>SPBSA12</b></p>   <p>Dieses Produkt enthält eine Lichtquelle der Energieeffizienzklasse F</p>	<p><b>1292</b></p>
	<p>LED-Aufbauleuchte für Spiegelpaneel mit LED-Mini-Stecker, 6000 K, 17,3 W, 2160 Lumen, EEK E <b>Helligkeit dimmbar</b></p> <p><i>LED-lighting for mirror panel with LED-mini-plug, 6000 K, 17,3 W, 2160 lumen, EEC E brightness dimmable</i></p>	<p>120,0 2,4 10,0</p> 	<p><b>AWP120</b></p>   <p>Dieses Produkt enthält eine Lichtquelle der Energieeffizienzklasse E</p>	<p><b>439</b></p>

EEK/EEC=Energieeffizienzklasse/energy efficiency category  
Leuchtmittel sind nicht austauschbar / illuminants are not interchangeable.

# 3100scala »Spiegelpaneele und Zubehör/ mirror panels and accessoires«

Beschreibung Description	Maße in cm Dimensions in cm			Artikel-Nr. Article no.	Türanschlag Door stop	Identnummer ID number
	B/W	H	T/D			
 <p>Spiegelpaneel, Sensorschalter, satiniert, LED Beleuchtung, 4000 K, 17,3 W, 2415 Lumen, EEK G <b>Helligkeit dimmbar</b></p> <p><i>mirror panel, sensor switch, satined, LED-lighting, 4000 K, 17,3 W, 2415 lumen, EEC G</i> <b>brighness dimmable</b></p>	55,0	78,0	2,8	<b>SPE55</b>   Dieses Produkt enthält eine Lichtquelle der Energieeffizienzklasse G	1131	
 <p>Spiegelpaneel, Sensorschalter, satiniert, LED Beleuchtung, 4000 K, 13,5 W, 1890 Lumen, EEK G <b>Helligkeit dimmbar</b></p> <p><i>mirror panel, sensor switch, satined, LED-lighting, 4000 K, 13,5 W, 1890 lumen, EEC G</i> <b>brighness dimmable</b></p>	55,0	55,0	2,8	<b>SPK55</b>   Dieses Produkt enthält eine Lichtquelle der Energieeffizienzklasse G	992	
 <p>Spiegelpaneel, Sensorschalter, satiniert, LED Beleuchtung, 4000 K, 20,8 W, 2905 Lumen, EEK G <b>Helligkeit dimmbar</b></p> <p><i>mirror panel, sensor switch, satined, LED-lighting, 4000 K, 20,8 W, 2905 lumen, EEC G</i> <b>brighness dimmable</b></p>	78,0	78,0	2,8	<b>SPK78</b>   Dieses Produkt enthält eine Lichtquelle der Energieeffizienzklasse G	1292	
 <p>Schubkasteneinsatz (Kunststoff) nur für oberen Auszug vom WT-Unterschrank SCUA122 rund</p> <p><i>drawer insert part (plastic) only for top drawer from base cabinet round SCUA122</i></p>	33,7	4,3	30,6	<b>SCIBEG3</b>	69	
 <p>Steckdose/Powerbox für Spiegelschränke Ausführung <b>Schweiz</b> IP44 mit USB-C Stecker</p> <p><i>Power socket for mirror cabinets Switzerland type IP44 with USB-C plug</i></p>				<b>Mehrpreis extra charge</b>	138	
 <p>Steckdose/Powerbox für Spiegelschränke Ausführung <b>Frankreich</b> mit USB-C Stecker</p> <p><i>Power socket for mirror cabinets France type with USB-C plug</i></p>				<b>Mehrpreis extra charge</b>	138	

EEK/EEC=Energieeffizienzklasse/energy efficiency category  
Leuchtmittel sind nicht austauschbar / illuminants are not interchangeable.

**i** Weiteres Zubehör finden Sie im Register 3970 und Beistellschränke im Register 3990.  
Further accessoires can be found in register 3970 and side cabinets in register 3990.



# 3130azure







# »3130azure«

## Piktogramme/pictograms



Mineralmarmor Waschtisch  
Marble minerals washbasin



LED Lichtfarbe kalt  
LED colour temperature cold



LED mit Bewegungssensor  
LED with motion sensor



LED Lichtfarbe warm  
LED colour temperature warm



LED mit Sensorschalter,  
Helligkeit dimmbar  
LED with sensor switch,  
brightness dimmable



LED Lichtfarbe regelbar,  
Helligkeit dimmbar  
LED colour temperature adjust-  
able, brightness dimmable



LED Lichtfarbe schaltbar bzw. regelbar  
LED colour temperature adjustable

## Mineralmarmor Waschtisch Weiß Alpin Glanz Marble minerals washbasin gloss alpine white

≈ Beckenmaße in cm (BxHxT)  
basin dimensions in cm (WxHxD)

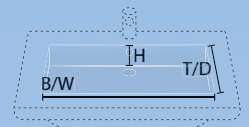

MWAZU6 | 56 x 12 x 30 cm  
MWAZUL6 | 56 x 12 x 30 cm\*



MWAZU8 | 68 x 12 x 30 cm  
MWAZUL8 | 68 x 12 x 30 cm\*



Detail



MWAZU10 | 68 x 12 x 30 cm  
MWAZUL10 | 68 x 12 x 30 cm\*



MWAZU12D | 56 x 12 x 30 cm  
MWAZUL12D | 56 x 12 x 30 cm\*



MWAZU14D | 61 x 12 x 30 cm  
MWAZUL14D | 61 x 12 x 30 cm\*



\* (L) mit LED-Beleuchtung  
(L) with LED lighting

### Mineralmarmor Glanz/gloss marble minerals

PG1



**Weiß Alpin Glanz**  
Gloss Alpine White  
AZ69

Bei granitfarbigen Waschtischen kann es zu Farbabweichungen kommen, da der Gelcoat die Farbgebung maßgeblich beeinflusst und sich im Laufe der Zeit die Farbe durch Lichteinflüsse (Sonneneinstrahlung) verändern kann.  
Colour deviations may occur with granite-coloured washbasins and the colour may change over time due to the influence of direct sunlight.

### Mineralmarmor Granit/granite marble minerals

PG2

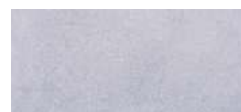

**Granit Weiß Glimmer**  
White Granite Glimmer  
AZ74



**Granit Grau Glimmer**  
Grey Granite Glimmer  
AZ73

## Schränke/cabinets 3130azure

### Frontfarben/front colours

#### MDF-foliert/MDF coated

449



**Kastanie Graphit Nachbildung**  
Graphite Chestnut Finish  
AZC\_

273



**Eiche Struktur Natur Nachbildung**  
Oak Structure Nature Finish  
AZM\_

235



**Eiche Struktur Weiß Nachbildung** NEW  
Oak Structure White Finish  
AZL\_

226



**Eiche Struktur Braun Nachbildung** NEW  
Oak Structure Brown Finish  
AZH\_

952



**Rot Glanz** NEW  
Gloss Red  
AZR\_

961



**Weiß Glanz**  
Gloss White  
AZG\_

438



**Anthrazit Glanz**  
Gloss Anthracite  
AZF\_

### Korpusfarben/basic shell colours

#### PG 2 Dickkante/thick edge

490



**Kastanie Graphit Nachbildung**  
Graphite Chestnut Finish  
C/AZ45

473



**Eiche Struktur Natur Nachbildung**  
Oak Structure Nature Finish  
M/AZ55

435



**Eiche Struktur Weiß Nachbildung** NEW  
Oak Structure White Finish  
L/AZ40

426



**Eiche Struktur Braun Nachbildung** NEW  
Oak Structure Brown Finish  
H/AZ70

286



**Weiß Seidenglanz**  
Silk Gloss White  
E/AZ86

#### PG 3 MDF-foliert/MDF-coated

042



**Weiß Glanz Folie**  
Gloss White  
G/AZ50

438



**Anthrazit Glanz Folie**  
Gloss Anthracite  
F/AZ30

# »3130azure«

## Griffe/handles



**Chrom Glanz**  
Gloss Chrome

Griffnummer/handlenumber: 285/286

⌀-⌀ 160 mm/320 mm



**Edelstahl Optik** NEW

Stainless design

Griffnummer/handlenumber: 205/206

⌀-⌀ 128 mm/460 mm



**Schwarz Matt Struktur** NEW

Matt Black Structure

Griffnummer/handlenumber: 237/238

⌀-⌀ 128 mm/320 mm

⌀-⌀ = Bohrabstand/hole spacing

Die Angabe einer Griffnummer ist ausreichend. Die Griffe werden passend zur jeweiligen Schrankbreite beigelegt.  
The indication of one handle number is sufficient. The handles are supplied to match the respective cabinet width.

## Beleuchtung / lighting



**Aufbauleuchte LED**  
Top light LED



**Aufbauleuchte LED**  
Top light LED



**Aufbauleuchte LED**  
Top light LED

**Lichtfarbe Tageslicht (Kalt)**

Luminous colour natural light (cold)



FLS60, FLS90

**Lichtfarbe Wohlfühllicht (Warm)**

Luminous colour warm light



FLS60, FLS90











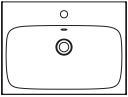

AZA60, AZA80

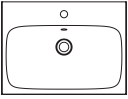

AWP60, AWP80,  
AWP100, AWP120,  
AWP140

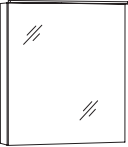

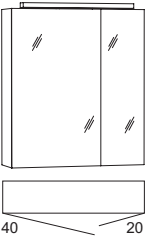
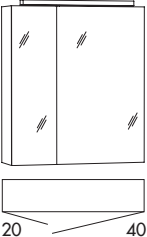

Die Steckdose / Powerbox für Spiegelschränke ist auch in Ausführung für die Schweiz / Frankreich erhältlich. Bitte Mehrpreis beachten (siehe Seite 14).  
The power socket for mirror cabinets is also available for Switzerland / France. Please note extra charge (see page 14).

# 3130azure »60 cm Mineralmarmor/marble minerals«

Beschreibung Description	Maße in cm Dimensions in cm			Artikel-Nr. Article no.	Türanschlag Door stop	Identnummer ID number	
	B/W	H	T/D			PG1 Weiß alpin/gloss alpine	PG2 Granit/granite
 <p>Mineralmarmor-Waschtisch inkl. Überlauf <i>marble minerals washbasin incl. overflow</i></p>	60,5	1,5	45,0	<b>MWAZU6</b> 		<b>1011</b>	<b>1338</b>
 <p>Mineralmarmor-Waschtisch inkl. Überlauf <b>mit LED-Beleuchtung und Bewegungs- sensor, 6000 K, 5,3 W, 413 Lumen, EEK G</b> <i>marble minerals washbasin incl. overflow with LED-lighting and motion sensor 6000 K, 5,3 W, 413 lumen, EEC G</i></p>	60,5	3,0	45,0	<b>MWAZUL6</b>    Dieses Produkt enthält eine Lichtquelle der Energieeffizienzklasse G		<b>1436</b>	<b>1753</b>
 <p>Waschtisch-Unterschrank 2 Auszüge <i>washbasin base cabinet 2 extensions</i></p>	60,0	47,8	44,5	<b>WMZAA6</b>  ehemals DWMZAA6		<b>1462</b>	<b>1693</b>
<p><b>Aufbauleuchte/top light</b></p>  <p>Spiegelschrank, 1 beidseitig verspiegelte Tür, 2 Glaseinlegeböden, inkl. Schalter/ Steckdose, <b>LED Aufbauleuchte FLS60 2800-6500 K, 12 W, 926 Lumen, EEK G</b> <b>Helligkeit dimmbar</b> <i>mirror cabinet, 1 door mirrored on both sides, 2 glass boards, incl. switch/socket LED lighting FLS60, 2800-6500 K, 12 W, 926 lumen, EEC G brightness dimmable</i></p>	60,0	68,2	13,6	<b>SFLA6L</b> <b>SFLA6R</b>   Dieses Produkt enthält eine Lichtquelle der Energieeffizienzklasse G	Links/left Rechts/right	<b>2119</b>	
<p><b>Aufbauleuchte/top light</b></p>  40 20  20 40 <p>Spiegelschrank, 2 beidseitig verspiegelte Türen, 2 Glaseinlegeböden, inkl. Schalter/ Steckdose, <b>LED Aufbauleuchte FLS60 2800-6500 K, 12 W, 926 Lumen, EEK G</b> <b>Helligkeit dimmbar</b> <i>mirror cabinet, 2 doors mirrored on both sides, 2 glass boards, incl. switch/socket LED lighting FLS60, 2800-6500 K, 12 W, 926 lumen, EEC G brightness dimmable</i></p>	60,0	68,2	13,6	<b>SFLA62L</b>   <b>SFLA62R</b>  Dieses Produkt enthält eine Lichtquelle der Energieeffizienzklasse G		<b>2237</b>	

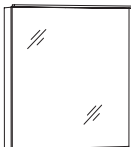
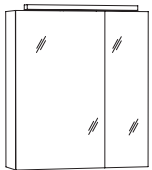

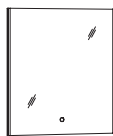







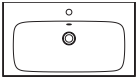

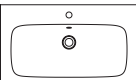
EEK/EEC=Energieeffizienzklasse/energy efficiency category  
Leuchtmittel sind nicht austauschbar / illuminants are not interchangeable.

# 3130azure »60 cm Mineralmarmor/marble minerals«

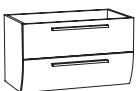
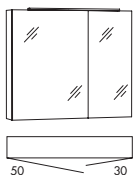
Beschreibung Description	Maße in cm Dimensions in cm			Artikel-Nr. Article no.	Türanschlag Door stop	Identnummer ID number
	B/W	H	T/D			
<p><b>Aufbauleuchte/top light</b></p>  <p>Spiegelschrank, 1 beidseitig verspiegelte Tür, 2 Glaseinlegeböden, inkl. Schalter/Steckdose, <b>LED Aufbauleuchte AZA60 4000 K</b>, 17,3 W, 2160 Lumen, EEK E</p> <p><i>mirror cabinet, 1 door mirrored on both sides, 2 glass boards, incl. switch/socket</i> <b>LED lighting AZA60, 4000 K</b>, 17,3 W, 2160 lumen, EEC E</p>	60,0	68,2	13,6	<b>SAZA6L</b> <b>SAZA6R</b>	Links/ <i>left</i> Rechts/ <i>right</i>	<b>1522</b>
<p><b>Aufbauleuchte/top light</b></p>  <p>Spiegelschrank, 2 beidseitig verspiegelte Türen, 2 Glaseinlegeböden, inkl. Schalter/Steckdose, <b>LED Aufbauleuchte AZA60 4000 K</b>, 17,3 W, 2160 Lumen, EEK E</p> <p><i>mirror cabinet, 2 doors mirrored on both sides, 2 glass boards, incl. switch/socket</i> <b>LED lighting AZA60, 4000 K</b>, 17,3 W, 2160 lumen, EEC E</p>	60,0	68,2	13,6	<b>SAZA62L</b>  <b>SAZA62R</b>		<b>1638</b>
<p><b>Aufbauleuchte/top light</b></p>  <p>Spiegelpaneel, inkl. Schalter Mitte unten, <b>LED Aufbauleuchte FLS60, umschaltbar in 2 Lichtfarben, 4000/6000 K</b>, 12 W, 926 Lumen, EEK G</p> <p><i>mirror panel, incl. switch center below,</i> <b>LED lighting FLS60, two switchable luminous colours, 4000/6000 K</b>, 12 W, 926 lumen, EEC G</p>	60,0	68,2	2,8	<b>SPFLA6</b>		<b>1556</b>
<p><b>Aufbauleuchte/top light</b></p>  <p>Spiegelpaneel, Sensorschalter, seitliche LED-Beleuchtung 6000 K, 2x 6,3 W, 2x 660 Lumen, EEK F <b>Helligkeit dimmbar</b></p> <p><i>mirror panel, sensor switch, lateral LED-lighting 6000 K, 2x 6,3 W, 2x 660 lumen, EEC F</i> <b>brighness dimmable</b></p>	60,0	68,2	2,8	<b>SPBSA6</b>		<b>1107</b>
<p><b>Aufbauleuchte/top light</b></p>  <p>LED-Aufbauleuchte für Spiegelpaneel mit LED-Mini-Stecker, 6000 K, 8,6 W, 792 Lumen, EEK E <b>Helligkeit dimmbar</b></p> <p><i>LED-lighting for mirror panel with LED-mini-plug,</i> 6000 K, 8,6 W, 792 lumen, EEC E <b>brighness dimmable</b></p>	60,0	2,4	10,0	<b>AWP60</b>		<b>323</b>

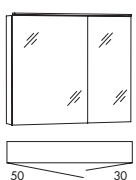







EEK/EEC=Energieeffizienzklasse/energy efficiency category  
Leuchtmittel sind nicht austauschbar / illuminants are not interchangeable.

# 3130azure »80 cm Mineralmarmor/marble minerals«

Beschreibung Description	Maße in cm Dimensions in cm			Artikel-Nr. Article no.	Türanschlag Door stop	Identnummer ID number	
	B/W	H	T/D			PG1 Weiß alpin/gloss alpine	PG2 Granit/granite
 <p>Mineralmarmor-Waschtisch inkl. Überlauf <i>marble minerals washbasin incl. overflow</i></p>	80,5	1,5	45,0	<b>MWAZU8</b> 		<b>1128</b>	<b>1476</b>
 <p>Mineralmarmor-Waschtisch inkl. Überlauf <b>mit LED-Beleuchtung und Bewegungs- sensor, 6000 K, 7,2 W, 562 Lumen, EEK G</b> <i>marble minerals washbasin incl. overflow with LED-lighting and motion sensor 6000 K, 7,2 W, 562 lumen, EEC G</i></p>	80,5	3,0	45,0	<b>MWAZUL8</b>    Dieses Produkt enthält eine Lichtquelle der Energieeffizienzklasse G		<b>1589</b>	<b>1937</b>
 <p>Waschtisch-Unterschrank 2 Auszüge <i>washbasin base cabinet 2 extensions</i></p>	80,0	47,8	44,5	<b>WMZAA8</b>  ehemals DWMZAA8		<b>1732</b>	<b>1958</b>
<p><b>Aufbauleuchte/top light</b></p>  <p>Spiegelschrank, 2 beidseitig verspiegelte Türen, 2 Glaseinlegeböden, inkl. Schalter/ Steckdose, <b>LED Aufbauleuchte SFL60</b> <b>2800-6500 K, 12 W, 926 Lumen, EEK G</b> <b>Helligkeit dimmbar</b> <i>mirror cabinet, 2 doors mirrored on both sides, 2 glass boards, incl. switch/socket LED lighting SFL60, 2800-6500 K, 12 W, 926 lumen, EEC G brightness dimmable</i></p>	80,0	68,2	13,6	<b>SFLA8L</b>   <b>SFLA8R</b>  Dieses Produkt enthält eine Lichtquelle der Energieeffizienzklasse G		<b>2422</b>	
<p><b>Aufbauleuchte/top light</b></p>  <p>Spiegelschrank, 2 beidseitig verspiegelte Türen, 2 Glaseinlegeböden, inkl. Schalter/ Steckdose, <b>LED Aufbauleuchte AZA80</b> <b>4000 K, 23,0 W, 2880 Lumen, EEK E</b>   <b>SAZA8L</b>   <b>SAZA8R</b>  Dieses Produkt enthält eine Lichtquelle der Energieeffizienzklasse E</p>	80,0	68,2	13,6	<b>SAZA8L</b>   <b>SAZA8R</b>  Dieses Produkt enthält eine Lichtquelle der Energieeffizienzklasse E		<b>1777</b>	

EEK/EEC=Energyeffizienzklasse/energy efficiency category  
Leuchtmittel sind nicht austauschbar / illuminants are not interchangeable.

# 3130azure »80 cm Mineralmarmor/*marble minerals*«

Beschreibung <i>Description</i>	Maße in cm <i>Dimensions in cm</i>			Artikel-Nr. <i>Article no.</i>	Türanschlag <i>Door stop</i>	Identnummer <i>ID number</i>
	B/W	H	T/D			
<p><b>Aufbauleuchte/top light</b></p>  <p>Spiegelpaneel, inkl. Schalter Mitte unten, <b>LED Aufbauleuchte FLS60, umschaltbar in 2 Lichtfarben, 4000/6000 K, 12 W, 926 Lumen, EEK G</b></p> <p><i>mirror panel, incl. switch center below, <b>LED lighting FLS60, two switchable luminous colours, 4000/6000 K, 12 W, 926 lumen, EEC G</b></i></p>	80,0	68,2	2,8	<b>SPFLA8</b>		<b>1603</b>
Dieses Produkt enthält eine Lichtquelle der Energieeffizienzklasse G						
 <p>Spiegelpaneel, Sensorschalter, seitliche LED-Beleuchtung 6000 K, 2x 6,3 W, 2x 660 Lumen, EEK F <b>Helligkeit dimmbar</b></p> <p><i>mirror panel, sensor switch, lateral LED-lighting 6000 K, 2x 6,3 W, 2x 660 lumen, EEC F <b>brighness dimmable</b></i></p>	80,0	68,2	2,8	<b>SPBSA8</b>	 	<b>1154</b>
Dieses Produkt enthält eine Lichtquelle der Energieeffizienzklasse F						
 <p>LED-Aufbauleuchte für Spiegelpaneel mit LED-Mini-Stecker, 6000 K, 10,8 W, 1350 Lumen, EEK E <b>Helligkeit dimmbar</b></p> <p><i>LED-lighting for mirror panel with LED-mini-plug, 6000 K, 10,8 W, 1350 lumen, EEC E <b>brighness dimmable</b></i></p>	80,0	2,4	10,0	<b>AWP80</b>	 	<b>370</b>
Dieses Produkt enthält eine Lichtquelle der Energieeffizienzklasse E						





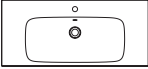
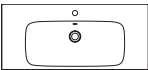
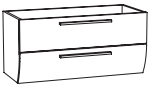
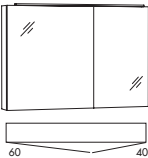
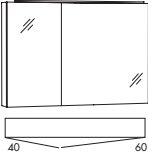



EEK/EEC=Energieeffizienzklasse/energy efficiency category  
Leuchtmittel sind nicht austauschbar / illuminants are not interchangeable.

# 3130azure »100 cm Mineralmarmor/ marble minerals«

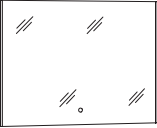
Beschreibung Description	Maße in cm Dimensions in cm			Artikel-Nr. Article no.	Türanschlag Door stop	Identnummer ID number	
	B/W	H	T/D			PG1 Weiß alpin/gloss alpine	PG2 Granit/granite
 <p>Mineralmarmor-Waschtisch inkl. Überlauf</p> <p><i>marble minerals washbasin incl. overflow</i></p>	100,5	1,5	45,0	<b>MWAZU10</b>		<b>1338</b>	<b>1661</b>
 <p>Mineralmarmor-Waschtisch inkl. Überlauf <b>mit LED-Beleuchtung und Bewegungs- sensor, 6000 K, 9,1 W, 706 Lumen, EEK G</b></p> <p><i>marble minerals washbasin incl. overflow <b>with LED-lighting and motion sensor 6000 K, 9,1 W, 706 lumen, EEC G</b></i></p>	100,5	3,0	45,0	<b>MWAZUL10</b>		<b>1846</b>	<b>2168</b>
 <p>Waschtisch-Unterschrank 2 Auszüge</p> <p><i>washbasin base cabinet 2 extensions</i></p>	100,0	47,8	44,5	<b>WMZAA10</b>		<b>1845</b>	<b>2075</b>
<p><b>Aufbauleuchte/top light</b></p>  <p>Spiegelschrank, 2 beidseitig verspiegelte Türen, 2 Glaseinlegeböden, inkl. Schalter/ Steckdose, <b>LED Aufbauleuchte FLS90</b> <b>2800-6500 K, 17,5 W,</b> <b>1390 Lumen, EEK G</b> <b>Helligkeit dimmbar</b></p> <p><i>mirror cabinet, 2 doors mirrored on both sides, 2 glass boards, incl. switch/socket <b>LED lighting FLS90, 2800-6500 K,</b> <b>17,5 W, 1390 lumen, EEC G</b> <b>brighness dimmable</b></i></p>	100,0	68,2	13,6	<b>SFLA10L</b>		<b>2663</b>	
 <p><b>Aufbauleuchte/top light</b></p> <p>Spiegelschrank, 2 beidseitig verspiegelte Türen, 2 Glaseinlegeböden, inkl. Schalter/ Steckdose, <b>LED Aufbauleuchte AZA80</b> <b>4000 K, 23,0 W, 2880 Lumen, EEK E</b></p> <p><i>mirror cabinet, 2 doors mirrored on both sides, 2 glass boards, incl. switch/socket <b>LED lighting AZA80, 4000 K, 23,0 W,</b> <b>2880 lumen, EEC E</b></i></p>	100,0	68,2	13,6	<b>SAZA10L</b>		<b>1961</b>	











EEK/EEC=Energieeffizienzklasse/energy efficiency category  
Leuchtmittel sind nicht austauschbar / illuminants are not interchangeable.



Beschreibung <i>Description</i>	Maße in cm <i>Dimensions in cm</i>			Artikel-Nr. <i>Article no.</i>	Türanschlag <i>Door stop</i>	Identnummer <i>ID number</i>
	B/W	H	T/D			
<p><b>Aufbauleuchte/top light</b></p>  <p>Spiegelpaneel, inkl. Schalter Mitte unten, <b>LED Aufbauleuchte FLS90, umschaltbar in 2 Lichtfarben, 4000/6000 K, 17,5 W, 1390 Lumen, EEK G</b></p> <p><i>mirror panel, incl. switch center below, LED lighting FLS90, two switchable luminous colours, 4000/6000 K, 17,5 W, 1390 lumen, EEC G</i></p>	100,0	68,2	2,8	<b>SPFLA10</b>		<b>1661</b>
Dieses Produkt enthält eine Lichtquelle der Energieeffizienzklasse G						
 <p>Spiegelpaneel, Sensorschalter, seitliche LED-Beleuchtung 6000 K, 2x 6,3 W, 2x 660 Lumen, EEK F <b>Helligkeit dimmbar</b></p> <p><i>mirror panel, sensor switch, lateral LED-lighting 6000 K, 2x 6,3 W, 2x 660 lumen, EEC F brightness dimmable</i></p>	100,0	68,2	2,8	<b>SPBSA10</b>	 	<b>1246</b>
Dieses Produkt enthält eine Lichtquelle der Energieeffizienzklasse F						
 <p>LED-Aufbauleuchte für Spiegelpaneel mit LED-Mini-Stecker, 6000 K, 13,7 W, 1440 Lumen, EEK F <b>Helligkeit dimmbar</b></p> <p><i>LED-lighting for mirror panel with LED-mini-plug, 6000 K, 13,7 W, 1440 lumen, EEC F brightness dimmable</i></p>	100,0	2,4	10,0	<b>AWP100</b>	 	<b>415</b>
Dieses Produkt enthält eine Lichtquelle der Energieeffizienzklasse F						

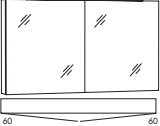

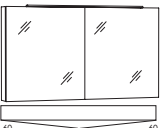





EEK/EEC=Energieeffizienzklasse/energy efficiency category  
Leuchtmittel sind nicht austauschbar / illuminants are not interchangeable.

# 3130azure »120 cm Mineralmarmor/marble minerals«

Beschreibung Description	Maße in cm Dimensions in cm			Artikel-Nr. Article no.	Türanschlag Door stop	Identnummer ID number	
	B/W	H	T/D			PG1 Weiß alpin/gloss alpine	PG2 Granit/granite
 <p>Mineralmarmor-Doppel-Waschtisch inkl. Überlauf <i>marble minerals double washbasin incl. overflow</i></p>	120,5	1,5	45,0	<b>MWAZU12D</b> 		<b>1614</b>	<b>2017</b>
 <p>Mineralmarmor-Doppel-Waschtisch inkl. Überlauf <b>mit LED-Beleuchtung und Bewegungs- sensor, 6000 K, 11,0 W, 828 Lumen, EEK G</b> <i>marble minerals double washbasin incl. overflow <b>with LED-lighting and motion sensor 6000 K, 11,0 W, 828 lumen, EEC G</b></i></p>	120,5	3,0	45,0	<b>MWAZUL12D</b>    Dieses Produkt enthält eine Lichtquelle der Energieeffizienzklasse G		<b>2143</b>	<b>2547</b>
 <p>Waschtisch-Unterschrank 4 Auszüge <i>washbasin base cabinet 4 extensions</i></p>	120,0	47,8	44,5	<b>WMZAAAA12</b> ehemals DWMZAAAA12		<b>3064</b>	<b>3292</b>
<p><b>Aufbauleuchte/top light</b></p>  <p>Spiegelschrank, 2 beidseitig verspiegelte Türen, 4 Glaseinlegeböden, inkl. Schalter/ Steckdose, <b>LED Aufbauleuchte FLS90</b> <b>2800-6500 K, 17,5 W, 1390 Lumen, EEK G</b> <b>Helligkeit dimmbar</b> <i>mirror cabinet, 2 doors mirrored on both sides, 4 glass boards, incl. switch/socket <b>LED lighting FLS90, 2800-6500 K, 17,5 W, 1390 lumen, EEC G</b> <b>brighness dimmable</b></i></p>	120,0	68,2	13,6	<b>SFLA12</b>  Dieses Produkt enthält eine Lichtquelle der Energieeffizienzklasse G		<b>3222</b>	
<p><b>Aufbauleuchte/top light</b></p>  <p>Spiegelschrank, 2 beidseitig verspiegelte Türen, 4 Glaseinlegeböden, inkl. Schalter/ Steckdose, <b>LED Aufbauleuchte AZA80</b> <b>4000 K, 23,0 W, 2880 Lumen, EEK E</b> <i>mirror cabinet, 2 doors mirrored on both sides, 4 glass boards, incl. switch/socket <b>LED lighting AZA80, 4000 K, 23,0 W, 2880 lumen, EEC E</b></i></p>	120,0	68,2	13,6	<b>SAZA12</b>  Dieses Produkt enthält eine Lichtquelle der Energieeffizienzklasse E	<b>NEW</b>		<b>2145</b>

EEK/EEC=Energieeffizienzklasse/energy efficiency category  
Leuchtmittel sind nicht austauschbar / illuminants are not interchangeable.











# 3130azure »120 cm Mineralmarmor/marble minerals«

Beschreibung Description	Maße in cm Dimensions in cm			Artikel-Nr. Article no.	Türanschlag Door stop	Identnummer ID number
	B/W	H	T/D			
<p><b>Aufbauleuchte/top light</b></p>  <p>Spiegelpaneel, inkl. Schalter Mitte unten, <b>LED Aufbauleuchte FLS90, umschaltbar in 2 Lichtfarben, 4000/6000 K, 17,5 W, 1390 Lumen, EEK G</b></p> <p><i>mirror panel, incl. switch center below, <b>LED lighting FLS90, two switchable luminous colours, 4000/6000 K, 17,5 W, 1390 lumen, EEC G</b></i></p>	120,0	68,2	2,8	<b>SPFLA12</b>		<b>1714</b>
Dieses Produkt enthält eine Lichtquelle der Energieeffizienzklasse G						
 <p>Spiegelpaneel, Sensorschalter, seitliche LED-Beleuchtung 6000 K, 2x 6,3 W, 2x 660 Lumen, EEK F <b>Helligkeit dimmbar</b></p> <p><i>mirror panel, sensor switch, lateral LED-lighting 6000 K, 2x 6,3 W, 2x 660 lumen, EEC F <b>brighness dimmable</b></i></p>	120,0	68,2	2,8	<b>SPBSA12</b>	 	<b>1292</b>
Dieses Produkt enthält eine Lichtquelle der Energieeffizienzklasse F						
 <p>LED-Aufbauleuchte für Spiegelpaneel mit LED-Mini-Stecker, 6000 K, 17,3 W, 2160 Lumen, EEK E <b>Helligkeit dimmbar</b></p> <p><i>LED-lighting for mirror panel with LED-mini-plug, 6000 K, 17,3 W, 2160 lumen, EEC E <b>brighness dimmable</b></i></p>	120,0	2,4	10,0	<b>AWP120</b>	 	<b>439</b>
Dieses Produkt enthält eine Lichtquelle der Energieeffizienzklasse E						

EEK/EEC=Energieeffizienzklasse/energy efficiency category

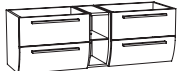
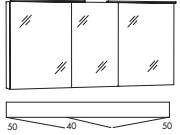

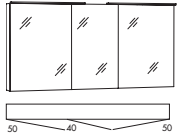



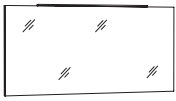

Leuchtmittel sind nicht austauschbar / illuminants are not interchangeable.

# 3130azure »140 cm Mineralmarmor/marble minerals«

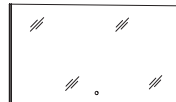
Beschreibung Description	Maße in cm Dimensions in cm			Artikel-Nr. Article no.	Türanschlag Door stop	Identnummer ID number	
	B/W	H	T/D			PG1 Weiß alpin/gloss alpine	PG2 Granit/granite
 <p>Mineralmarmor-Doppel-Waschtisch inkl. Überlauf <i>marble minerals double washbasin incl. overflow</i></p>	140,5	1,5	45,0	<b>MWAZU14D</b> 		<b>1880</b>	<b>2353</b>
 <p>Mineralmarmor-Doppel-Waschtisch inkl. Überlauf <b>mit LED-Beleuchtung und Bewegungs- sensor, 6000 K, 13,0 W, 994 Lumen, EEK G</b> <i>marble minerals double washbasin incl. overflow with LED-lighting and motion sensor 6000 K, 13,0 W, 994 lumen, EEC G</i></p>	140,5	3,0	45,0	<b>MWAZUL14D</b>    Dieses Produkt enthält eine Lichtquelle der Energieeffizienzklasse G		<b>2445</b>	<b>2913</b>
 <p>Waschtisch-Unterschrank 4 Auszüge, 1 Regal mittig <i>washbasin base cabinet 4 extensions, 1 shelf in center</i></p>	140,0	47,8	44,5	<b>WMZAAAA14</b> ehemals DWMZAAAA14		<b>3368</b>	<b>3599</b>
<p><b>Aufbauleuchte/top light</b></p>  <p>Spiegelschrank, 3 beidseitig verspiegelte Türen, 4 Glaseinlegeböden, inkl. Schalter/ Steckdose, <b>LED Aufbauleuchte 2x FLS60</b> <b>2800-6500 K, 2x 12,0 W, 2x 926 Lumen,</b> EEK G <b>Helligkeit dimmbar</b> <i>mirror cabinet, 3 doors mirrored on both sides, 4 glass boards, incl. switch/socket LED lighting 2x FLS60, 2800-6500 K, 2x 12,0 W, 2x 926 lumen, EEC G brightness dimmable</i></p>	140,0	68,2	13,6	<b>SFLA14</b>  Dieses Produkt enthält eine Lichtquelle der Energieeffizienzklasse G		<b>3849</b>	
<p><b>Aufbauleuchte/top light</b></p>  <p>Spiegelschrank, 3 beidseitig verspiegelte Türen, 4 Glaseinlegeböden, inkl. Schalter/ Steckdose, <b>LED Aufbauleuchte 2x AZA60</b> <b>4000 K, 2x 17,3 W, 2x 2160 Lumen,</b> EEK E <b>NEW</b> <i>mirror cabinet, 3 doors mirrored on both sides, 4 glass boards, incl. switch/socket LED lighting 2x AZA60, 4000 K, 2x 17,3 W, 2x 2160 lumen, EEC E</i></p>	140,0	68,2	13,6	<b>SAZA14</b>  Dieses Produkt enthält eine Lichtquelle der Energieeffizienzklasse E		<b>2676</b>	

EEK/EEC=Energieeffizienzklasse/energy efficiency category  
Leuchtmittel sind nicht austauschbar / illuminants are not interchangeable.

# 3130azure »140 cm Mineralmarmor/marble minerals«

Beschreibung Description	Maße in cm Dimensions in cm			Artikel-Nr. Article no.	Türanschlag Door stop	Identnummer ID number
	B/W	H	T/D			
<p><b>Aufbauleuchte/top light</b></p>  <p>Spiegelpaneel, inkl. Schalter Mitte unten, <b>LED Aufbauleuchte FLS90, umschaltbar in 2 Lichtfarben, 4000/6000 K, 17,5 W, 1390 Lumen, EEK G</b></p> <p><i>mirror panel, incl. switch center below, <b>LED lighting FLS90, two switchable luminous colours, 4000/6000 K, 17,5 W, 1390 lumen, EEC G</b></i></p>	140,0	68,2	2,8	<b>SPFLA14</b>		<b>1766</b>
Dieses Produkt enthält eine Lichtquelle der Energieeffizienzklasse G						
 <p>Spiegelpaneel, Sensorschalter, seitliche LED-Beleuchtung 6000 K, 2x 6,3 W, 2x 660 Lumen, EEK F <b>Helligkeit dimmbar</b></p> <p><i>mirror panel, sensor switch, lateral LED-lighting 6000 K, 2x 6,3 W, 2x 660 lumen, EEC F <b>brighness dimmable</b></i></p>	140,0	68,2	2,8	<b>SPBSA14</b>	 	<b>1384</b>
Dieses Produkt enthält eine Lichtquelle der Energieeffizienzklasse F						
 <p>LED-Aufbauleuchte für Spiegelpaneel mit LED-Mini-Stecker, 6000 K, 19,4 W, 2430 Lumen, EEK E <b>Helligkeit dimmbar</b></p> <p><i>LED-lighting for mirror panel with LED-mini-plug, 6000 K, 19,4 W, 2430 lumen, EEC E <b>brighness dimmable</b></i></p>	140,0	2,4	10,0	<b>AWP140</b>	 	<b>508</b>
Dieses Produkt enthält eine Lichtquelle der Energieeffizienzklasse E						

EEK/EEC=Energieeffizienzklasse/energy efficiency category

Leuchtmittel sind nicht austauschbar / illuminants are not interchangeable.

# 3130azure »Spiegelpaneele und Zubehör/ mirror panels and accessoires«

Beschreibung Description	Maße in cm Dimensions in cm			Artikel-Nr. Article no.	Türanschlag Door stop	Identnummer ID number
	B/W	H	T/D			
 <p>Spiegelpaneel, Sensorschalter, satiniert, LED Beleuchtung, 4000 K, 17,3 W, 2415 Lumen, EEK G <b>Helligkeit dimmbar</b></p> <p><i>mirror panel, sensor switch, satined, LED-lighting, 4000 K, 17,3 W, 2415 lumen, EEC G</i> <b>brighness dimmable</b></p>	55,0	78,0	2,8	<b>SPE55</b>   Dieses Produkt enthält eine Lichtquelle der Energieeffizienzklasse G	1131	
 <p>Spiegelpaneel, Sensorschalter, satiniert, LED Beleuchtung, 4000 K, 13,5 W, 1890 Lumen, EEK G <b>Helligkeit dimmbar</b></p> <p><i>mirror panel, sensor switch, satined, LED-lighting, 4000 K, 13,5 W, 1890 lumen, EEC G</i> <b>brighness dimmable</b></p>	55,0	55,0	2,8	<b>SPK55</b>   Dieses Produkt enthält eine Lichtquelle der Energieeffizienzklasse G	992	
 <p>Spiegelpaneel, Sensorschalter, satiniert, LED Beleuchtung, 4000 K, 20,8 W, 2905 Lumen, EEK G <b>Helligkeit dimmbar</b></p> <p><i>mirror panel, sensor switch, satined, LED-lighting, 4000 K, 20,8 W, 2905 lumen, EEC G</i> <b>brighness dimmable</b></p>	78,0	78,0	2,8	<b>SPK78</b>   Dieses Produkt enthält eine Lichtquelle der Energieeffizienzklasse G	1292	
 <p>Schubkasteneinsatz (Kunststoff) für oberen Auszug vom WT-Unterschrank</p> <p><i>drawer insert part (plastic) for top drawer from base cabinet</i></p>	33,7	4,3	28,0	<b>SABEG3</b>	69	
 <p>Steckdose/Powerbox für Spiegelschränke Ausführung <b>Schweiz</b> IP44 mit USB-C Stecker</p> <p><i>Power socket for mirror cabinets Switzerland type IP44 with USB-C plug</i></p>				<b>Mehrpreis extra charge</b>	138	
 <p>Steckdose/Powerbox für Spiegelschränke Ausführung <b>Frankreich</b> mit USB-C Stecker</p> <p><i>Power socket for mirror cabinets France type with USB-C plug</i></p>				<b>Mehrpreis extra charge</b>	138	

EEK/EEC=Energieeffizienzklasse/energy efficiency category

Leuchtmittel sind nicht austauschbar / illuminants are not interchangeable.

**i** Weiteres Zubehör finden Sie im Register 3970 und Beistellschränke im Register 3990.  
*Further accessoires can be found in register 3970 and side cabinets in register 3990.*



# 3160motion







# »3160motion«

## Piktogramme/pictograms



Mineralmarmor Waschtisch  
Marble minerals washbasin



LED Lichtfarbe kalt  
LED colour temperature cold



LED Lichtfarbe regelbar,  
Helligkeit dimmbar  
LED colour temperature adjust-  
able, brightness dimmable



LED mit Sensorschalter,  
Helligkeit dimmbar  
LED with sensor switch,  
brightness dimmable

## Mineralmarmor Waschtisch weiß alpin Glanz (MN69) Marble minerals washbasin gloss alpine white (MN69)

≈ Beckenmaße in cm (BxHxD)  
basin dimensions in cm (WxHxD)

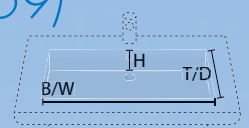

MNWM90R



MNWM90L



MNWM120R



MNWM120L



MNWM150R



MNWM150L

Alle Becken/all basins = ca. 66 x 12 x 30 cm

## Schränke/cabinets 3160motion

### Frontfarben/front colours

#### MDF-foliert/MDF-coated

449



**Kastanie Graphit Nachbildung**  
*Graphite Chestnut Finish*  
MNC\_

273



**Eiche Struktur Natur Nachbildung**  
*Oak Structure Nature Finish*  
MNM\_

235



**Eiche Struktur Weiß Nachbildung** NEW  
*Oak Structure White Finish*  
MNL\_

226



**Eiche Struktur Braun Nachbildung** NEW  
*Oak Structure Brown Finish*  
MNH\_

961



**Weiß Glanz**  
*Gloss White*  
MNG\_

438



**Anthrazit Glanz**  
*Gloss Anthracite*  
MNF\_

### Korpusfarben/basic shell colours

#### PG 2 Dickkante/thick edge

490



**Kastanie Graphit Nachbildung**  
*Graphite Chestnut Finish*  
C/MN45

473



**Eiche Struktur Natur Nachbildung**  
*Oak Structure Nature Finish*  
M/MN55

435



**Eiche Struktur Weiß Nachbildung** NEW  
*Oak Structure White Finish*  
L/MN40

426



**Eiche Struktur Braun Nachbildung** NEW  
*Oak Structure Brown Finish*  
H/MN70

#### PG 3 MDF-foliert/MDF-coated

042



**Weiß Glanz Folie**  
*Gloss White*  
G/MN50

438



**Anthrazit Glanz Folie**  
*Gloss Anthracite*  
F/MN30

# »3160motion«

## Regalfarben/ shelf colours

287		<b>Weiß Seidenglanz</b> <i>Silk Gloss White</i> MN86	285		<b>Anthrazit Seidenglanz</b> <i>Silk Gloss Anthracite</i> MN84
491		<b>Kastanie Graphit Nachbildung</b> <i>Graphite Chestnut Finish</i> MN45	474		<b>Eiche Struktur Natur Nachbildung</b> <i>Oak Structure Nature Finish</i> MN55
436		<b>Eiche Struktur Weiß Nachbildung</b> <span style="background-color: #0070C0; color: white; padding: 2px;">NEW</span> <i>Oak Structure White Finish</i> MN40	427		<b>Eiche Struktur Braun Nachbildung</b> <span style="background-color: #0070C0; color: white; padding: 2px;">NEW</span> <i>Oak Structure Brown Finish</i> MN70

## Griffe/handles

	<b>Chrom Glanz</b> <i>Gloss Chrome</i> Griffnummer/handlenumber: 138/147 ⌀-⌀ 96 mm/484-484 mm		<b>Chrom Glanz</b> <i>Gloss Chrome</i> Griffnummer/handlenumber: 438/258 ⌀-⌀ 160 mm/320 mm
--	--	--	---

⌀-⌀ = Bohrabstand/hole spacing









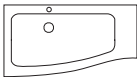

Die Angabe einer Griffnummer ist ausreichend. Die Griffe werden passend zur jeweiligen Schrankbreite beigelegt.  
The indication of one handle number is sufficient. The handles are supplied to match the respective cabinet width.

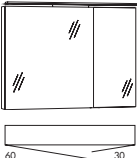
## Beleuchtung / lighting

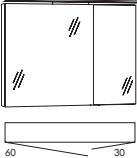
		Lichtfarbe Tageslicht (Kalt) <i>Louminous colour natural light (cold)</i>	Lichtfarbe Wohlfühllicht (Warm) <i>Louminous colour warm light</i>
	<b>Aufbauleuchte LED</b> <i>Top light LED</i>		
		FLL90, FLS90	FLS90
	<b>Acrylloberboden LED</b> <i>Acrylic top LED</i>		
	<b>Aufbauleuchte LED</b> <i>Top light LED</i>		
		AWP90, AWP120	

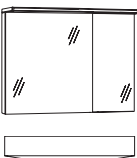
Die Steckdose / Powerbox für Spiegelschränke ist auch in Ausführung für die Schweiz / Frankreich erhältlich. Bitte Mehrpreis beachten (siehe Seite 25).  
The power socket for mirror cabinets is also available for Switzerland / France. Please note extra charge (see page 25).

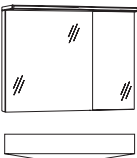





# 3160motion »90 cm R Mineralmarmor/marble minerals«

Beschreibung Description	Maße in cm Dimensions in cm			Artikel-Nr. Article no.	Türanschlag Door stop	Identnummer ID number	
	B/W	H	T/D			PG2	PG3
 <p>Mineralmarmor-Waschtisch inkl. Überlauf</p> <p><i>marble minerals washbasin incl. overflow</i></p>	90,4	2,0	48,5/ 35,5	<b>MNWM90R</b>		<b>819</b>	
 <p>Waschtisch-Unterschrank 2 Auszüge</p> <p><i>washbasin base cabinet 2 extensions</i></p>	90,0	47,8	48,0/ 35,1	<b>MNWUG92DR</b>		<b>1822</b>	<b>1984</b>
<p><b>Aufbauleuchte/top light</b></p>  <p>Spiegelschrank, 2 beidseitig verspiegelte Türen, 2 Glaseinlegeböden, inkl. Schalter/Steckdose, <b>LED Aufbauleuchte FLL90</b> <b>6000 K</b>, 17,0 W, 1751 Lumen, EEK E</p> <p><i>mirror cabinet, 2 doors mirrored on both sides, 2 glass boards, incl. switch/socket <b>LED lighting FLL90, 6000 K, 17,0 W,</b> 1751 lumen, EEC E</i></p>	90,0	68,2	13,6	<b>SFL563</b>		<b>1937</b>	
 <p>Spiegelschrank, 2 beidseitig verspiegelte Türen, 2 Glaseinlegeböden, inkl. Schalter/Steckdose Steckdose, <b>LED Aufbauleuchte FLS90</b> <b>2800-6500 K</b>, 17,5 W, 1390 Lumen, EEK G, <b>Helligkeit dimmbar</b></p> <p><i>mirror cabinet, 2 doors mirrored on both sides, 2 glass boards, incl. switch/socket <b>LED lighting FLS90, 2800-6500 K,</b> 17,5 W, 1390 lumen, EEC G <b>brighness dimmable</b></i></p>	90,0	68,2	13,6	<b>SFLZ63</b>		<b>2423</b>	
<p><b>Acryloberboden/ acryl top</b></p>  <p>Spiegelschrank, 2 beidseitig verspiegelte Türen, 2 Glaseinlegeböden, inkl. Schalter/Steckdose, <b>Acryloberboden</b> mit LED-Beleuchtung, <b>6000 K</b>, 8,5 W 1020 Lumen, EEK F</p> <p><i>mirror cabinet, 2 doors mirrored on both sides, 2 glass boards, incl. switch/socket, <b>acryl-top</b> with LED lighting, <b>6000 K, 8,5 W,</b> 1020 lumen, EEC F</i></p>	90,0	68,2	13,6	<b>SAOS63</b>		<b>1915</b>	
<p><b>Acryloberboden/ acryl top</b></p>  <p>Spiegelschrank, 2 beidseitig verspiegelte Türen, 2 Glaseinlegeböden, inkl. Schalter/Steckdose, <b>Acryloberboden</b> mit LED-Beleuchtung, <b>2800-6500 K</b>, 17,0 W, 2550 Lumen, EEK F <b>Helligkeit dimmbar</b></p> <p><i>mirror cabinet, 2 doors mirrored on both sides, 2 glass boards, incl. switch/socket, <b>acryl-top</b> with LED lighting, <b>2800-6500 K,</b> 17,0 W, 2550 lumen, EEC F <b>brighness dimmable</b></i></p>	90,0	68,2	13,6	<b>SAOZ63</b>		<b>2353</b>	

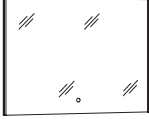
EEK/EEC=Energieeffizienzklasse/energy efficiency category









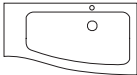

Leuchtmittel sind nicht austauschbar / illuminants are not interchangeable.

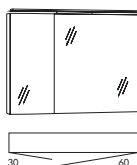
# 3160motion »90 cm R Mineralmarmor/marble minerals«

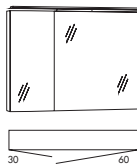
Beschreibung Description	Maße in cm Dimensions in cm			Artikel-Nr. Article no.	Türanschlag Door stop	Identnummer ID number
	B/W	H	T/D			
 <p>Spiegelpaneel, Sensorschalter, seitliche LED-Beleuchtung 6000 K, 2x 6,3 W, 2x 660 Lumen, EEK F <b>Helligkeit dimmbar</b></p> <p><i>mirror panel, sensor switch, lateral LED-lighting 6000 K, 2x 6,3 W, 2x 660 lumen, EEC F</i> <b>brighness dimmable</b></p>	90,0	68,2	2,8	<b>SPBSA9</b>   Dieses Produkt enthält eine Lichtquelle der Energieeffizienzklasse F		1200
 <p>LED-Aufbauleuchte für Spiegelpaneel mit LED-Mini-Stecker, 6000 K, 12,5 W, 1566 Lumen, EEK E <b>Helligkeit dimmbar</b></p> <p><i>LED-lighting for mirror panel with LED-mini-plug, 6000 K, 12,5 W, 1566 lumen, EEC E</i> <b>brighness dimmable</b></p>	90,0	2,4	10,0	<b>AWP90</b>   Dieses Produkt enthält eine Lichtquelle der Energieeffizienzklasse E		392

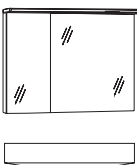
EEK/EEC=Energieeffizienzklasse/energy efficiency category  
Leuchtmittel sind nicht austauschbar / illuminants are not interchangeable.

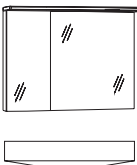

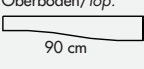



# 3160motion »90 cm L Mineralmarmor/marble minerals«

Beschreibung Description	Maße in cm Dimensions in cm			Artikel-Nr. Article no.	Türanschlag Door stop	Identnummer ID number	
	B/W	H	T/D			PG2	PG3
 <p>Mineralmarmor-Waschtisch inkl. Überlauf <i>marble minerals washbasin incl. overflow</i></p>	90,4	2,0	48,5/ 35,5	<b>MNWM90L</b> 		<b>819</b>	
 <p>Waschtisch-Unterschrank 2 Auszüge <i>washbasin base cabinet 2 extensions</i></p>	90,0	47,8	35,1/ 48,0	<b>MNWUG92DL</b>		<b>1822</b>	<b>1984</b>
<p><b>Aufbauleuchte/top light</b></p>  <p>Spiegelschrank, 2 beidseitig verspiegelte Türen, 2 Glaseinlegeböden, inkl. Schalter/Steckdose, <b>LED Aufbauleuchte FLL90</b> <b>6000 K</b>, 17,0 W, 1751 Lumen, EEK E <i>mirror cabinet, 2 doors mirrored on both sides, 2 glass boards, incl. switch/socket LED lighting FLL90, 6000 K, 17,0 W, 1751 lumen, EEC E</i></p>	90,0	68,2	13,6	<b>SFLS36</b> 		<b>1937</b>	
<p><b>Aufbauleuchte/top light</b></p>  <p>Spiegelschrank, 2 beidseitig verspiegelte Türen, 2 Glaseinlegeböden, inkl. Schalter/Steckdose Steckdose, <b>LED Aufbauleuchte FLS90</b> <b>2800-6500 K</b>, 17,5 W, 1390 Lumen, EEK G, <b>Helligkeit dimmbar</b> <i>mirror cabinet, 2 doors mirrored on both sides, 2 glass boards, incl. switch/socket LED lighting FLS90, 2800-6500 K, 17,5 W, 1390 lumen, EEC G brightness dimmable</i></p>	90,0	68,2	13,6	<b>SFLZ36</b> 		<b>2423</b>	
<p><b>Acryloberboden/ acryl top</b></p>  <p>Spiegelschrank, 2 beidseitig verspiegelte Türen, 2 Glaseinlegeböden, inkl. Schalter/Steckdose, <b>Acryloberboden</b> mit LED-Beleuchtung, <b>6000 K</b>, 8,5 W 1020 Lumen, EEK F <i>mirror cabinet, 2 doors mirrored on both sides, 2 glass boards, incl. switch/socket, acryl-top with LED lighting, 6000 K, 8,5 W, 1020 lumen, EEC F</i></p>	90,0	68,2	13,6	<b>SAOS36</b> 		<b>1915</b>	
<p><b>Acryloberboden/ acryl top</b></p>  <p>Spiegelschrank, 2 beidseitig verspiegelte Türen, 2 Glaseinlegeböden, inkl. Schalter/Steckdose, <b>Acryloberboden</b> mit LED-Beleuchtung, <b>2800-6500 K</b>, 17,0 W, 2550 Lumen, EEK F <b>Helligkeit dimmbar</b> <i>mirror cabinet, 2 doors mirrored on both sides, 2 glass boards, incl. switch/socket, acryl-top with LED lighting, 2800-6500 K, 17,0 W, 2550 lumen, EEC F brightness dimmable</i></p>	90,0	68,2	13,6	<b>SAOZ36</b> 		<b>2353</b>	

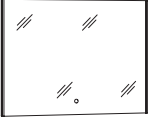
EEK/EEC=Energyeffizienzklasse/energy efficiency category

Leuchtmittel sind nicht austauschbar / illuminants are not interchangeable.



Beschreibung Description	Maße in cm Dimensions in cm			Artikel-Nr. Article no.	Türanschlag Door stop	Identnummer ID number
	B/W	H	T/D			





	<p>Spiegelpaneel, Sensorschalter, seitliche LED-Beleuchtung 6000 K, 2x 6,3 W, 2x 660 Lumen, EEK F <b>Helligkeit dimmbar</b></p> <p><i>mirror panel, sensor switch, lateral LED-lighting 6000 K, 2x 6,3 W, 2x 660 lumen, EEC F</i> <b>brighthness dimmable</b></p>	90,0	68,2	2,8	<p><b>SPBSA9</b></p>   <p>Dieses Produkt enthält eine Lichtquelle der Energieeffizienzklasse F</p>	1200
	<p>LED-Aufbauleuchte für Spiegelpaneel mit LED-Mini-Stecker, 6000 K, 12,5 W, 1566 Lumen, EEK E <b>Helligkeit dimmbar</b></p> <p><i>LED-lighting for mirror panel with LED-mini-plug, 6000 K, 12,5 W, 1566 lumen, EEC E</i> <b>brighthness dimmable</b></p>	90,0	2,4	10,0	<p><b>AWP90</b></p>   <p>Dieses Produkt enthält eine Lichtquelle der Energieeffizienzklasse E</p>	392

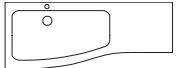

EEK/EEC=Energieeffizienzklasse/energy efficiency category  
Leuchtmittel sind nicht austauschbar / illuminants are not interchangeable.



# 3160motion »120 cm R Mineralmarmor/marble minerals «

Beschreibung Description	Maße in cm Dimensions in cm			Artikel-Nr. Article no.	Türanschlag Door stop	Identnummer ID number
	B/W	H	T/D			

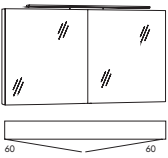
	Mineralmarmor-Waschtisch inkl. Überlauf  <i>marble minerals washbasin incl. overflow</i>	120,4	2,0	48,5/ 35,5	<b>MNWM120R</b> 		<b>1061</b>
--	---	-------	-----	---------------	--	--	-------------

							PG2	PG3
	Waschtisch-Unterschrank 2 Auszüge  <i>washbasin base cabinet 2 extensions</i>	90,0	47,8	48,0/ 35,1	<b>MNWUG92DR</b>		<b>1822</b>	<b>1984</b>
	Unterschrank 1 Tür, 1 Glaseinlegeboden  <i>base cabinet 1 door, 1 glass shelve</i>	30,0	47,8	35,1	<b>MNWU30D</b>	Rechts/ <i>right</i>	<b>461</b>	<b>600</b>
	Unterschrank 1 Einschubregal, 1 Auszug  <i>base cabinet 1 push in shelf, 1 extension</i>	30,0	47,8	35,1	<b>MNWUEA30D</b>		<b>785</b>	<b>969</b>
	Unterschrank 2 Auszüge  <i>base cabinet 2 extensions</i>	30,0	47,8	35,1	<b>MNWUA32D</b>		<b>854</b>	<b>1038</b>

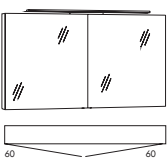
	<b>Aufbauleuchte/top light</b> Spiegelschrank, 2 beidseitig verspiegelte Türen, 4 Glaseinlegeböden, inkl. Schalter/Steckdose, <b>LED Aufbauleuchte FLL90</b> <b>6000 K, 17,0 W, 1751 Lumen, EEK E</b>  <i>mirror cabinet, 2 doors mirrored on both sides, 4 glass boards, incl. switch/socket <b>LED lighting FLL90, 6000 K, 17,0 W, 1751 lumen, EEC E</b></i>	120,0	68,2	13,6	<b>SFLS66</b> 		<b>2136</b>
						Dieses Produkt enthält eine Lichtquelle der Energieeffizienzklasse E	

	<b>Aufbauleuchte/top light</b> Spiegelschrank, 2 beidseitig verspiegelte Türen, 4 Glaseinlegeböden, inkl. Schalter/Steckdose Steckdose, <b>LED Aufbauleuchte FLS90</b> <b>2800-6500 K, 17,5 W, 1390 Lumen,</b> EEK G, <b>Helligkeit dimmbar</b>  <i>mirror cabinet, 2 doors mirrored on both sides, 4 glass boards, incl. switch/socket <b>LED lighting FLS90, 2800-6500 K, 17,5 W, 1390 lumen, EEC G</b> <b>brighness dimmable</b></i>	120,0	68,2	13,6	<b>SFLZ66</b> 		<b>2607</b>
						Dieses Produkt enthält eine Lichtquelle der Energieeffizienzklasse G	







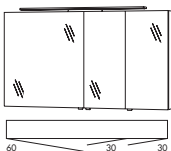

EEK/EEC=Energieeffizienzklasse/energy efficiency category  
Leuchtmittel sind nicht austauschbar / illuminants are not interchangeable.

 Regalfarben unbedingt mit angeben, Übersicht siehe Seite 3. Please indicate shelf colours, overview see page 3.

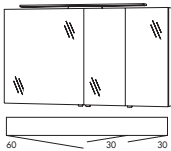

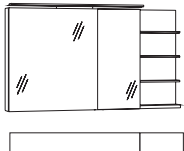

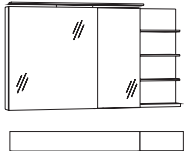



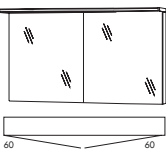

# 3160motion »120 cm R Mineralmarmor/marble minerals «

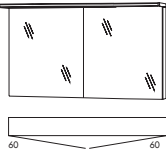

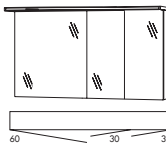

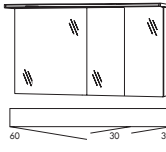





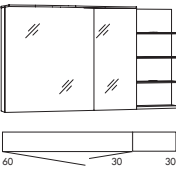

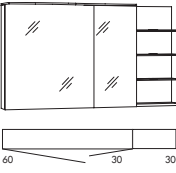
Beschreibung Description	Maße in cm Dimensions in cm			Artikel-Nr. Article no.	Türanschlag Door stop	Identnummer ID number
	B/W	H	T/D			

<p>Aufbauleuchte/top light</p>  <p>Spiegelschrank, 3 beidseitig verspiegelte Türen, 6 Glaseinlegeböden, inkl. Schalter/Steckdose, <b>LED Aufbauleuchte FLL90 6000 K</b>, 17,0 W, 1751 Lumen, EEK E</p> <p><i>mirror cabinet, 3 doors mirrored on both sides, 6 glass boards, incl. switch/socket</i> <b>LED lighting FLL90, 6000 K, 17,0 W, 1751 lumen, EEC E</b></p>	120,0	68,2	13,6	<p><b>SFLS633</b></p>  <p>Dieses Produkt enthält eine Lichtquelle der Energieeffizienzklasse E</p>	2307
<p>Aufbauleuchte/top light</p>  <p>Spiegelschrank, 3 beidseitig verspiegelte Türen, 6 Glaseinlegeböden, inkl. Schalter/Steckdose, <b>LED Aufbauleuchte FLS90 2800-6500 K</b>, 17,5 W, 1390 Lumen, EEK G, <b>Helligkeit dimmbar</b></p> <p><i>mirror cabinet, 3 doors mirrored on both sides, 6 glass boards, incl. switch/socket</i> <b>LED lighting FLS90, 2800-6500 K, 17,5 W, 1390 lumen, EEC G</b> <b>brighness dimmable</b></p>	120,0	68,2	13,6	<p><b>SFLS633</b></p>  <p>Dieses Produkt enthält eine Lichtquelle der Energieeffizienzklasse G</p>	2838
<p>Aufbauleuchte/top light</p>  <p>Spiegelschrank, 2 beidseitig verspiegelte Türen, 2 Glaseinlegeböden, 1 Regal inkl. Schalter/Steckdose, <b>LED Aufbauleuchte FLL90 6000 K</b>, 17,0 W, 1751 Lumen, EEK E</p> <p><i>mirror cabinet, 2 doors mirrored on both sides, 2 glass boards, 1 shelf incl. switch/socket,</i> <b>LED lighting FLL90, 6000 K, 17,0 W, 1751 lumen, EEC E</b></p>	120,0	68,2	13,6	<p><b>SFLS63R</b></p> <p><b>SFLS63RSL</b></p>  <p>Dieses Produkt enthält eine Lichtquelle der Energieeffizienzklasse E</p>	<p>Regal (korpusfarbig) mit Glasablageböden/shelf (basic shell coloured) with glass boards</p> <p>2376</p> <p>3068</p>
<p>Aufbauleuchte/top light</p>  <p>Spiegelschrank, 2 beidseitig verspiegelte Türen, 2 Glaseinlegeböden, 1 Regal inkl. Schalter/Steckdose, <b>LED Aufbauleuchte FLS90 2800-6500 K</b>, 17,5 W, 1390 Lumen, EEK G, <b>Helligkeit dimmbar</b></p> <p><i>mirror cabinet, 2 doors mirrored on both sides, 2 glass boards, 1 shelf incl. switch/socket,</i> <b>LED lighting FLS90, 2800-6500 K, 17,5 W, 1390 lumen, EEC G</b> <b>brighness dimmable</b></p>	120,0	68,2	13,6	<p><b>SFLZ63R</b></p> <p><b>SFLZ63RSL</b></p>  <p>Dieses Produkt enthält eine Lichtquelle der Energieeffizienzklasse G</p>	<p>Regal mit Spiegel und Glasablageböden (LED)/shelf with mirror and glass boards (LED)</p> <p>2860</p> <p>3575</p>

EEK/EEC=Energieeffizienzklasse/energy efficiency category  
Leuchtmittel sind nicht austauschbar / illuminants are not interchangeable.

Beschreibung <i>Description</i>	Maße in cm <i>Dimensions in cm</i>			Artikel-Nr. <i>Article no.</i>	Türanschlag <i>Door stop</i>	Identnummer <i>ID number</i>
	B/W	H	T/D			
<p>Acryl oberboden/ <i>acryl top</i></p>  <p>Spiegelschrank, 2 beidseitig verspiegelte Türen, 4 Glaseinlegeböden, inkl. Schalter/Steckdose, <b>Acryl oberboden</b> mit LED-Beleuchtung, <b>6000 K</b>, 11,5 W 1380 Lumen, EEK F</p> <p><i>mirror cabinet, 2 doors mirrored on both sides, 4 glass boards, incl. switch/socket, <b>acryl-top</b> with LED lighting, <b>6000 K</b>, 11,5 W, 1380 lumen, EEC F</i></p>	120,0	68,2	13,6	<p><b>SAOS66OR</b></p>  <p>Dieses Produkt enthält eine Lichtquelle der Energieeffizienzklasse F</p>		<b>2192</b>
<p>Acryl oberboden/ <i>acryl top</i></p>  <p>Spiegelschrank, 2 beidseitig verspiegelte Türen, 4 Glaseinlegeböden, inkl. Schalter/Steckdose, <b>Acryl oberboden</b> mit LED-Beleuchtung, <b>2800-6500 K</b>, 23,0 W, 3450 Lumen, EEK F <b>Helligkeit dimmbar</b></p> <p><i>mirror cabinet, 2 doors mirrored on both sides, 4 glass boards, incl. switch/socket, <b>acryl-top</b> with LED lighting, <b>2800-6500 K</b>, 23,0 W, 3450 lumen, EEC F <b>brighness dimmable</b></i></p>	120,0	68,2	13,6	<p><b>SAOZ66OR</b></p>  <p>Dieses Produkt enthält eine Lichtquelle der Energieeffizienzklasse F</p>		<b>2630</b>
<p>Acryl oberboden/ <i>acryl top</i></p>  <p>Spiegelschrank, 3 beidseitig verspiegelte Türen, 6 Glaseinlegeböden, inkl. Schalter/Steckdose, <b>Acryl oberboden</b> mit LED-Beleuchtung, <b>6000 K</b>, 11,5 W 1380 Lumen, EEK F</p> <p><i>mirror cabinet, 3 doors mirrored on both sides, 6 glass boards, incl. switch/socket, <b>acryl-top</b> with LED lighting, <b>6000 K</b>, 11,5 W, 1380 lumen, EEC F</i></p>	120,0	68,2	13,6	<p><b>SAOS633</b></p>  <p>Dieses Produkt enthält eine Lichtquelle der Energieeffizienzklasse F</p>		<b>2307</b>
<p>Acryl oberboden/ <i>acryl top</i></p>  <p>Spiegelschrank, 3 beidseitig verspiegelte Türen, 6 Glaseinlegeböden, inkl. Schalter/Steckdose, <b>Acryl oberboden</b> mit LED-Beleuchtung, <b>2800-6500 K</b>, 23,0 W, 3450 Lumen, EEK F <b>Helligkeit dimmbar</b></p> <p><i>mirror cabinet, 3 doors mirrored on both sides, 6 glass boards, incl. switch/socket, <b>acryl-top</b> with LED lighting, <b>2800-6500 K</b>, 23,0 W, 3450 lumen, EEC F <b>brighness dimmable</b></i></p>	120,0	68,2	13,6	<p><b>SAOZ633</b></p>  <p>Dieses Produkt enthält eine Lichtquelle der Energieeffizienzklasse F</p>		<b>2745</b>

EEK/EEC=Energieeffizienzklasse/energy efficiency category  
Leuchtmittel sind nicht austauschbar / *illuminants are not interchangeable.*



Beschreibung Description	Maße in cm Dimensions in cm			Artikel-Nr. Article no.	Türanschlag Door stop	Identnummer ID number
	B/W	H	T/D			
<p>Acryloberboden/ acryl top</p>  <p>Spiegelschrank, 2 beidseitig verspiegelte Türen, 2 Glaseinlegeböden, 1 Regal inkl. Schalter/Steckdose, <b>Acryloberboden</b> mit LED-Beleuchtung, <b>6000 K</b>, 8,5 W 1020 Lumen, EEK F</p> <p><i>mirror cabinet, 2 doors mirrored on both sides, 2 glass boards, 1 shelf incl. switch/socket, <b>acryl-top</b> with LED lighting, <b>6000 K</b>, 8,5 W, 1020 lumen, EEC F</i></p>	120,0	68,2	13,6	<p><b>SAOS63R</b></p> <p><b>SAOS63RLS</b></p>  <p>Dieses Produkt enthält eine Lichtquelle der Energieeffizienzklasse F</p>		<p>Regal (korpusfarbig) mit Glasablageböden/<i>shelf (basic shell coloured) with glass boards</i></p> <p>Regal mit Spiegel und Glasablageböden (LED)/<i>shelf with mirror and glass boards (LED)</i></p> <p><b>2261</b></p> <p><b>2929</b></p>
<p>Acryloberboden/ acryl top</p>  <p>Spiegelschrank, 2 beidseitig verspiegelte Türen, 2 Glaseinlegeböden, 1 Regal inkl. Schalter/Steckdose, <b>Acryloberboden</b> mit LED-Beleuchtung, <b>2800-6500 K</b>, 17,0 W, 2550 Lumen, EEK F <b>Helligkeit dimmbar</b></p> <p><i>mirror cabinet, 2 doors mirrored on both sides, 2 glass boards, 1 shelf incl. switch/socket, <b>acryl-top</b> with LED lighting, <b>2800-6500 K</b>, 17,0 W, 2550 lumen, EEC F <b>brighness dimmable</b></i></p>	120,0	68,2	13,6	<p><b>SAOZ63R</b></p> <p><b>SAOZ63RLS</b></p>  <p>Dieses Produkt enthält eine Lichtquelle der Energieeffizienzklasse F</p>		<p><b>2676</b></p> <p><b>3368</b></p>
 <p>Spiegelpaneel, Sensorschalter, seitliche LED-Beleuchtung 6000 K, 2x 6,3 W, 2x 660 Lumen, EEK F <b>Helligkeit dimmbar</b></p> <p><i>mirror panel, sensor switch, lateral LED-lighting 6000 K, 2x 6,3 W, 2x 660 lumen, EEC F <b>brighness dimmable</b></i></p>	120,0	68,2	2,8	<p><b>SPBSA12</b></p>    <p>Dieses Produkt enthält eine Lichtquelle der Energieeffizienzklasse F</p>		<b>1292</b>
 <p>LED-Aufbauleuchte für Spiegelpaneel mit LED-Mini-Stecker, 6000 K, 17,3 W, 2160 Lumen, EEK E <b>Helligkeit dimmbar</b></p> <p><i>LED-lighting for mirror panel with LED-mini-plug, 6000 K, 17,3 W, 2160 lumen, EEC E <b>brighness dimmable</b></i></p>	120,0	2,4	10,0	<p><b>AWP120</b></p>    <p>Dieses Produkt enthält eine Lichtquelle der Energieeffizienzklasse E</p>		<b>439</b>



EEK/EEC=Energieeffizienzklasse/energy efficiency category

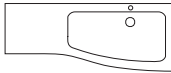

Leuchtmittel sind nicht austauschbar / illuminants are not interchangeable.

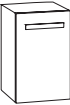
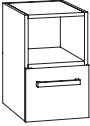

# 3160motion »120 cm L Mineralmarmor/marble minerals«

Beschreibung Description	Maße in cm Dimensions in cm			Artikel-Nr. Article no.	Türanschlag Door stop	Identnummer ID number
	B/W	H	T/D			

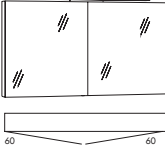
	Mineralmarmor-Waschtisch inkl. Überlauf  <i>marble minerals washbasin incl. overflow</i>	120,4	2,0	48,5/ 35,5	<b>MNWM120L</b> 		<b>1061</b>
--	---	-------	-----	---------------	--	--	-------------

							PG2	PG3
	Waschtisch-Unterschrank 2 Auszüge  <i>washbasin base cabinet 2 extensions</i>	90,0	47,8	35,1/ 48,0	<b>MNWUG92DL</b>		<b>1822</b>	<b>1984</b>
	Unterschrank 1 Tür, 1 Glaseinlegeboden  <i>base cabinet 1 door, 1 glass shelve</i>	30,0	47,8	35,1	<b>MNWU30D</b>	Links/ <i>left</i>	<b>461</b>	<b>600</b>
	Unterschrank 1 Einschubregal, 1 Auszug  <i>base cabinet 1 push in shelf, 1 extension</i>	30,0	47,8	35,1	<b>MNWUEA30D</b>		<b>785</b>	<b>969</b>
	Unterschrank 2 Auszüge  <i>base cabinet 2 extensions</i>	30,0	47,8	35,1	<b>MNWUA32D</b>		<b>854</b>	<b>1038</b>

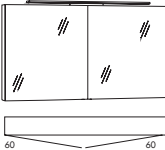



	<b>Aufbauleuchte/top light</b> Spiegelschrank, 2 beidseitig verspiegelte Türen, 4 Glaseinlegeböden, inkl. Schalter/Steckdose, <b>LED Aufbauleuchte FLL90</b> <b>6000 K, 17,0 W, 1751 Lumen, EEK E</b>  <i>mirror cabinet, 2 doors mirrored on both sides, 4 glass boards, incl. switch/socket <b>LED lighting FLL90, 6000 K, 17,0 W, 1751 lumen, EEC E</b></i>	120,0	68,2	13,6	<b>SFLS66</b> 		<b>2136</b>
--	---	-------	------	------	--	--	-------------

	<b>Aufbauleuchte/top light</b> Spiegelschrank, 2 beidseitig verspiegelte Türen, 4 Glaseinlegeböden, inkl. Schalter/Steckdose Steckdose, <b>LED Aufbauleuchte FLS90</b> <b>2800-6500 K, 17,5 W, 1390 Lumen,</b> <b>EEK G, Helligkeit dimmbar</b>  <i>mirror cabinet, 2 doors mirrored on both sides, 4 glass boards, incl. switch/socket <b>LED lighting FLS90, 2800-6500 K, 17,5 W, 1390 lumen, EEC G brightness dimmable</b></i>	120,0	68,2	13,6	<b>SFLZ66</b> 		<b>2607</b>
--	---	-------	------	------	--	--	-------------

EEK/EEC=Energieeffizienzklasse/energy efficiency category  
Leuchtmittel sind nicht austauschbar / illuminants are not interchangeable.

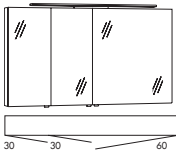
 Regalfarben unbedingt mit angeben, Übersicht siehe Seite 3. Please indicate shelf colours, overview see page 3.

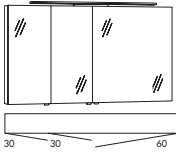





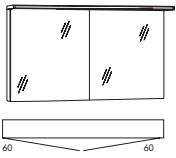

Beschreibung Description	Maße in cm Dimensions in cm			Artikel-Nr. Article no.	Türanschlag Door stop	Identnummer ID number
	B/W	H	T/D			

<p><b>Aufbauleuchte/top light</b></p> 	<p>Spiegelschrank, 3 beidseitig verspiegelte Türen, 6 Glaseinlegeböden, inkl. Schalter/Steckdose, <b>LED Aufbauleuchte FLL90 6000 K</b>, 17,0 W, 1751 Lumen, EEK E</p> <p><i>mirror cabinet, 3 doors mirrored on both sides, 6 glass boards, incl. switch/socket</i> <b>LED lighting FLL90, 6000 K, 17,0 W, 1751 lumen, EEC E</b></p>	120,0	68,2	13,6	<p><b>SFLS336</b></p>  <p>Dieses Produkt enthält eine Lichtquelle der Energieeffizienzklasse E</p>	<b>2307</b>
<p><b>Aufbauleuchte/top light</b></p> 	<p>Spiegelschrank, 3 beidseitig verspiegelte Türen, 6 Glaseinlegeböden, inkl. Schalter/Steckdose, <b>LED Aufbauleuchte FLS90 2800-6500 K</b>, 17,5 W, 1390 Lumen, EEK G, <b>Helligkeit dimmbar</b></p> <p><i>mirror cabinet, 3 doors mirrored on both sides, 6 glass boards, incl. switch/socket</i> <b>LED lighting FLS90, 2800-6500 K, 17,5 W, 1390 lumen, EEC G</b> <b>brighness dimmable</b></p>	120,0	68,2	13,6	<p><b>SFLS336</b></p>  <p>Dieses Produkt enthält eine Lichtquelle der Energieeffizienzklasse G</p>	<b>2838</b>

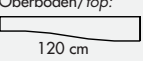
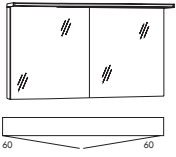
Regal (korpusfarbig) mit Glasablageböden/shelf (basic shell coloured) with glass boards	Regal mit Spiegel und Glasablageböden (LED)/shelf with mirror and glass boards (LED)
---	--

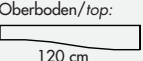
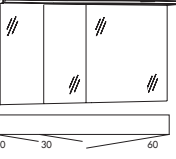
<p><b>Aufbauleuchte/top light</b></p> 	<p>Spiegelschrank, 2 beidseitig verspiegelte Türen, 2 Glaseinlegeböden, 1 Regal inkl. Schalter/Steckdose, <b>LED Aufbauleuchte FLL90 6000 K</b>, 17,0 W, 1751 Lumen, EEK E</p> <p><i>mirror cabinet, 2 doors mirrored on both sides, 2 glass boards, 1 shelf incl. switch/socket,</i> <b>LED lighting FLL90, 6000 K, 17,0 W, 1751 lumen, EEC E</b></p>	120,0	68,2	13,6	<p><b>SFLSR36</b></p> <p><b>SFLSR36LS</b></p>  <p>Dieses Produkt enthält eine Lichtquelle der Energieeffizienzklasse E</p>	<b>2376</b>	<b>3068</b>
<p><b>Aufbauleuchte/top light</b></p> 	<p>Spiegelschrank, 2 beidseitig verspiegelte Türen, 2 Glaseinlegeböden, 1 Regal inkl. Schalter/Steckdose, <b>LED Aufbauleuchte FLS90 2800-6500 K</b>, 17,5 W, 1390 Lumen, EEK G, <b>Helligkeit dimmbar</b></p> <p><i>mirror cabinet, 2 doors mirrored on both sides, 2 glass boards, 1 shelf incl. switch/socket,</i> <b>LED lighting FLS90, 2800-6500 K, 17,5 W, 1390 lumen, EEC G</b> <b>brighness dimmable</b></p>	120,0	68,2	13,6	<p><b>SFLZR36</b></p> <p><b>SFLZR36LS</b></p>  <p>Dieses Produkt enthält eine Lichtquelle der Energieeffizienzklasse G</p>	<b>2860</b>	<b>3575</b>

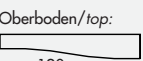
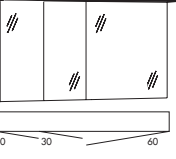







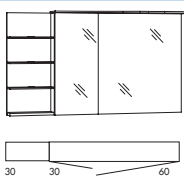
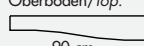

EEK/EEC=Energieeffizienzklasse/energy efficiency category  
Leuchtmittel sind nicht austauschbar / illuminants are not interchangeable.

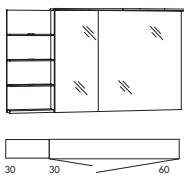
Beschreibung <i>Description</i>	Maße in cm <i>Dimensions in cm</i>			Artikel-Nr. <i>Article no.</i>	Türanschlag <i>Door stop</i>	Identnummer <i>ID number</i>
	B/W	H	T/D			
<p>Acryloberboden/ <i>acryl top</i></p>  <p>Spiegelschrank, 2 beidseitig verspiegelte Türen, 4 Glaseinlegeböden, inkl. Schalter/Steckdose, <b>Acryloberboden</b> mit LED-Beleuchtung, <b>6000 K</b>, 11,5 W 1380 Lumen, EEK F</p> <p><i>mirror cabinet, 2 doors mirrored on both sides, 4 glass boards, incl. switch/socket, <b>acryl-top</b> with LED lighting, <b>6000 K</b>, 11,5 W, 1380 lumen, EEC F</i></p>	120,0	68,2	13,6	<b>SAOS66OL</b>		<b>2192</b>
	Oberboden/top:  120 cm			Dieses Produkt enthält eine Lichtquelle der Energieeffizienzklasse F		
<p>Acryloberboden/ <i>acryl top</i></p>  <p>Spiegelschrank, 2 beidseitig verspiegelte Türen, 4 Glaseinlegeböden, inkl. Schalter/Steckdose, <b>Acryloberboden</b> mit LED-Beleuchtung, <b>2800-6500 K</b>, 23,0 W, 3450 Lumen, EEK F <b>Helligkeit dimmbar</b></p> <p><i>mirror cabinet, 2 doors mirrored on both sides, 4 glass boards, incl. switch/socket, <b>acryl-top</b> with LED lighting, <b>2800-6500 K</b>, 23,0 W, 3450 lumen, EEC F <b>brighness dimmable</b></i></p>	120,0	68,2	13,6	<b>SAOZ66OL</b>		<b>2630</b>
	Oberboden/top:  120 cm			Dieses Produkt enthält eine Lichtquelle der Energieeffizienzklasse F		
<p>Acryloberboden/ <i>acryl top</i></p>  <p>Spiegelschrank, 3 beidseitig verspiegelte Türen, 6 Glaseinlegeböden, inkl. Schalter/Steckdose, <b>Acryloberboden</b> mit LED-Beleuchtung, <b>6000 K</b>, 11,5 W 1380 Lumen, EEK F</p> <p><i>mirror cabinet, 3 doors mirrored on both sides, 6 glass boards, incl. switch/socket, <b>acryl-top</b> with LED lighting, <b>6000 K</b>, 11,5 W, 1380 lumen, EEC F</i></p>	120,0	68,2	13,6	<b>SAOS336</b>		<b>2307</b>
	Oberboden/top:  120 cm			Dieses Produkt enthält eine Lichtquelle der Energieeffizienzklasse F		
<p>Acryloberboden/ <i>acryl top</i></p>  <p>Spiegelschrank, 3 beidseitig verspiegelte Türen, 6 Glaseinlegeböden, inkl. Schalter/Steckdose, <b>Acryloberboden</b> mit LED-Beleuchtung, <b>2800-6500 K</b>, 23,0 W, 3450 Lumen, EEK F <b>Helligkeit dimmbar</b></p> <p><i>mirror cabinet, 3 doors mirrored on both sides, 6 glass boards, incl. switch/socket, <b>acryl-top</b> with LED lighting, <b>2800-6500 K</b>, 23,0 W, 3450 lumen, EEC F <b>brighness dimmable</b></i></p>	120,0	68,2	13,6	<b>SAOZ336</b>		<b>2745</b>
	Oberboden/top:  120 cm			Dieses Produkt enthält eine Lichtquelle der Energieeffizienzklasse F		

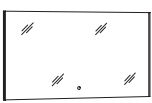
EEK/EEC=Energieeffizienzklasse/energy efficiency category

Leuchtmittel sind nicht austauschbar / *illuminants are not interchangeable.*



Beschreibung Description	Maße in cm Dimensions in cm			Artikel-Nr. Article no.	Türanschlag Door stop	Identnummer ID number
	B/W	H	T/D			



				Regal (korpusfarbig) mit Glasablageböden/ shelf (basic shell colour- red) with glass boards	Regal mit Spiegel und Glasablageböden (LED)/shelf with mirror and glass boards (LED)
<p>Acryloberboden/ acryl top</p> 	<p>Spiegelschrank, 2 beidseitig verspiegelte Türen, 2 Glaseinlegeböden, 1 Regal inkl. Schalter/Steckdose, <b>Acryloberboden</b> mit LED-Beleuchtung, <b>6000 K</b>, 8,5 W 1020 Lumen, EEK F</p> <p><i>mirror cabinet, 2 doors mirrored on both sides, 2 glass boards, 1 shelf incl. switch/socket, <b>acryl-top</b> with LED lighting, <b>6000 K</b>, 8,5 W, 1020 lumen, EEC F</i></p>	<p>120,0 68,2 13,6</p> <p>Oberboden/top: 90 cm</p> 	<p><b>SAOSR36</b></p>	<p><b>2261</b></p>	<p><b>2929</b></p>
			<p><b>SAOSR36LS</b></p>  <p>Dieses Produkt enthält eine Lichtquelle der Energieeffizienzklasse F</p>		
<p>Acryloberboden/ acryl top</p> 	<p>Spiegelschrank, 2 beidseitig verspiegelte Türen, 2 Glaseinlegeböden, 1 Regal inkl. Schalter/Steckdose, <b>Acryloberboden</b> mit LED-Beleuchtung, <b>2800-6500 K</b>, 17,0 W, 2550 Lumen, EEK F <b>Helligkeit dimmbar</b></p> <p><i>mirror cabinet, 2 doors mirrored on both sides, 2 glass boards, 1 shelf incl. switch/socket, <b>acryl-top</b> with LED lighting, <b>2800-6500 K</b>, 17,0 W, 2550 lumen, EEC F <b>brighness dimmable</b></i></p>	<p>120,0 68,2 13,6</p> <p>Oberboden/top: 90 cm</p> 	<p><b>SAOZR36</b></p>	<p><b>2676</b></p>	<p><b>3368</b></p>
			<p><b>SAOZR36LS</b></p>  <p>Dieses Produkt enthält eine Lichtquelle der Energieeffizienzklasse F</p>		
	<p>Spiegelpaneel, Sensorschalter, seitliche LED-Beleuchtung 6000 K, 2x 6,3 W, 2x 660 Lumen, EEK F <b>Helligkeit dimmbar</b></p> <p><i>mirror panel, sensor switch, lateral LED-lighting 6000 K, 2x 6,3 W, 2x 660 lumen, EEC F <b>brighness dimmable</b></i></p>	<p>120,0 68,2 2,8</p> <p><b>NEW</b></p>	<p><b>SPBSA12</b></p>  	<p><b>1292</b></p>	
			<p>Dieses Produkt enthält eine Lichtquelle der Energieeffizienzklasse F</p>		
	<p>LED-Aufbauleuchte für Spiegelpaneel mit LED-Mini-Stecker, 6000 K, 17,3 W, 2160 Lumen, EEK E <b>Helligkeit dimmbar</b></p> <p><i>LED-lighting for mirror panel with LED-mini-plug, 6000 K, 17,3 W, 2160 lumen, EEC E <b>brighness dimmable</b></i></p>	<p>120,0 2,4 10,0</p> <p><b>NEW</b></p>	<p><b>AWP120</b></p>  	<p><b>439</b></p>	
			<p>Dieses Produkt enthält eine Lichtquelle der Energieeffizienzklasse E</p>		

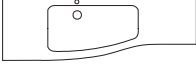

EEK/EEC=Energieeffizienzklasse/energy efficiency category  
Leuchtmittel sind nicht austauschbar / illuminants are not interchangeable.

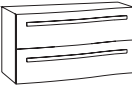
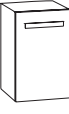

# 3160motion »150 cm R Mineralmarmor/*marble minerals*«

Beschreibung Description	Maße in cm Dimensions in cm			Artikel-Nr. Article no.	Türanschlag Door stop	Identnummer ID number
	B/W	H	T/D			

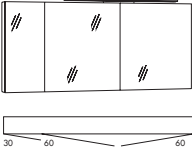
	Mineralmarmor-Waschtisch inkl. Überlauf  <i>marble minerals washbasin incl. overflow</i>	150,4	2,0	48,5/ 35,5	MNWM150R 		1209
--	---	-------	-----	---------------	---	--	------

							PG2	PG3
	Waschtisch-Unterschrank 2 Auszüge  <i>washbasin base cabinet 2 extensions</i>	90,0	47,8	48,0/ 35,1	MNWUG92DR		1822	1984
	Unterschrank 1 Tür, 1 Glaseinlegeboden  <i>base cabinet 1 door, 1 glass shelve</i>	30,0	47,8	35,1	MNWU30D	Rechts/ <i>right</i>	461	600
		30,0	47,8	48,0	MNWU30TD	Links/ <i>left</i>	508	646
	Unterschrank 1 Einschubregal, 1 Auszug  <i>base cabinet 1 push in shelf, 1 extension</i>	30,0	47,8	35,1	MNWUEA30D		785	969
		30,0	47,8	48,0	MNWUEA30TD		830	1016
	Unterschrank 2 Auszüge  <i>base cabinet 2 extensions</i>	30,0	47,8	35,1	MNWUA32D		854	1038
		30,0	47,8	48,0	MNWUA32TD		877	1061

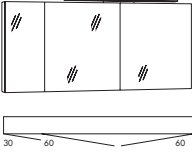
	<b>Aufbauleuchte/top light</b> Spiegelschrank, 3 beidseitig verspiegelte Türen, 6 Glaseinlegeböden, inkl. Schalter/Steckdose, <b>LED Aufbauleuchte FLL90 6000 K, 17,0 W, 1751 Lumen, EEK E</b>  <i>mirror cabinet, 3 doors mirrored on both sides, 6 glass boards, incl. switch/socket</i> <b>LED lighting FLL90, 6000 K, 17,0 W, 1751 lumen, EEC E</b>	150,0	68,2	13,6	SFLS366 		2538
						Dieses Produkt enthält eine Lichtquelle der Energieeffizienzklasse E	







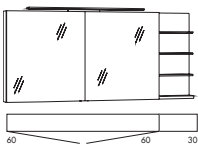

	<b>Aufbauleuchte/top light</b> Spiegelschrank, 3 beidseitig verspiegelte Türen, 6 Glaseinlegeböden, inkl. Schalter/Steckdose Steckdose, <b>LED Aufbauleuchte FLS90 2800-6500 K, 17,5 W, 1390 Lumen, EEK G, Helligkeit dimmbar</b>  <i>mirror cabinet, 3 doors mirrored on both sides, 6 glass boards, incl. switch/socket</i> <b>LED lighting FLS90, 2800-6500 K, 17,5 W, 1390 lumen, EEC G, brightness dimmable</b>	150,0	68,2	13,6	SFLZ366 		3045
						Dieses Produkt enthält eine Lichtquelle der Energieeffizienzklasse G	

EEK/EEC=Energieeffizienzklasse/energy efficiency category  
Leuchtmittel sind nicht austauschbar / illuminants are not interchangeable.

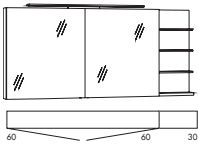
 Regalfarben unbedingt mit angeben, Übersicht siehe Seite 3. Please indicate shelf colours, overview see page 3.

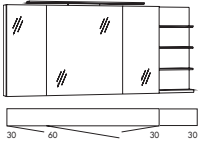

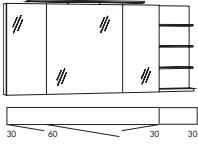



# 3160motion »150 cm R Mineralmarmor/marble minerals«

Beschreibung Description	Maße in cm Dimensions in cm			Artikel-Nr. Article no.	Türanschlag Door stop	Identnummer ID number
	B/W	H	T/D			
<p><b>Aufbauleuchte/top light</b></p>  <p>Spiegelschrank, 2 beidseitig verspiegelte Türen, 4 Glaseinlegeböden, 1 Regal inkl. Schalter/Steckdose, <b>LED Aufbauleuchte FLL90 6000 K</b>, 17,0 W, 1751 Lumen, EEK E</p> <p><i>mirror cabinet, 2 doors mirrored on both sides, 4 glass boards, 1 shelf incl. switch/socket, <b>LED lighting FLL90, 6000 K, 17,0 W, 1751 lumen, EEC E</b></i></p>	150,0	68,2	13,6	<p><b>SFLZ66R</b></p> <p><b>SFLZ66RLS</b></p>  <p>Dieses Produkt enthält eine Lichtquelle der Energieeffizienzklasse E</p>		<p><b>2561</b></p> <p><b>3275</b></p>
<p><b>Aufbauleuchte/top light</b></p>  <p>Spiegelschrank, 2 beidseitig verspiegelte Türen, 4 Glaseinlegeböden, 1 Regal inkl. Schalter/Steckdose, <b>LED Aufbauleuchte FLS90 2800-6500 K</b>, 17,5 W, 1390 Lumen, EEK G, <b>Helligkeit dimmbar</b></p> <p><i>mirror cabinet, 2 doors mirrored on both sides, 4 glass boards, 1 shelf incl. switch/socket, <b>LED lighting FLS90, 2800-6500 K, 17,5 W, 1390 lumen, EEC G brightness dimmable</b></i></p>	150,0	68,2	13,6	<p><b>SFLZ66R</b></p> <p><b>SFLZ66RLS</b></p>  <p>Dieses Produkt enthält eine Lichtquelle der Energieeffizienzklasse G</p>		<p><b>3045</b></p> <p><b>3761</b></p>
<p><b>Aufbauleuchte/top light</b></p>  <p>Spiegelschrank, 3 beidseitig verspiegelte Türen, 6 Glaseinlegeböden, 1 Regal inkl. Schalter/Steckdose, <b>LED Aufbauleuchte FLL90 6000 K</b>, 17,0 W, 1751 Lumen, EEK E</p> <p><i>mirror cabinet, 3 doors mirrored on both sides, 6 glass boards, 1 shelf incl. switch/socket, <b>LED lighting FLL90, 6000 K, 17,0 W, 1751 lumen, EEC E</b></i></p>	150,0	68,2	13,6	<p><b>SFLZ363R</b></p> <p><b>SFLZ363RLS</b></p>  <p>Dieses Produkt enthält eine Lichtquelle der Energieeffizienzklasse E</p>		<p><b>2745</b></p> <p><b>3460</b></p>
<p><b>Aufbauleuchte/top light</b></p>  <p>Spiegelschrank, 3 beidseitig verspiegelte Türen, 6 Glaseinlegeböden, 1 Regal inkl. Schalter/Steckdose, <b>LED Aufbauleuchte FLS90 2800-6500 K</b>, 17,5 W, 1390 Lumen, EEK G, <b>Helligkeit dimmbar</b></p> <p><i>mirror cabinet, 3 doors mirrored on both sides, 6 glass boards, 1 shelf incl. switch/socket, <b>LED lighting FLS90, 2800-6500 K, 17,5 W, 1390 lumen, EEC G brightness dimmable</b></i></p>	150,0	68,2	13,6	<p><b>SFLZ363R</b></p> <p><b>SFLZ363RLS</b></p>  <p>Dieses Produkt enthält eine Lichtquelle der Energieeffizienzklasse G</p>		<p><b>3253</b></p> <p><b>3968</b></p>

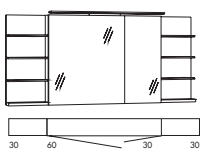
EEK/EEC=Energieeffizienzklasse/energy efficiency category  
Leuchtmittel sind nicht austauschbar / illuminants are not interchangeable.

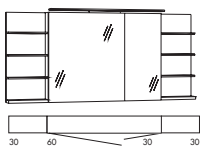



Beschreibung Description	Maße in cm Dimensions in cm			Artikel-Nr. Article no.	Türanschlag Door stop	Identnummer ID number
	B/W	H	T/D			

				Regal (korpusfarbig) mit Glasablageböden/ shelf (basic shell coloured) with glass boards	Regal mit Spiegel und Glasablageböden (LED)/ shelf with mirror and glass boards (LED)	
<p><b>Aufbauleuchte/top light</b></p>  <p>Spiegelschrank, 2 beidseitig verspiegelte Türen, 2 Glaseinlegeböden, 2 Regale inkl. Schalter/Steckdose, <b>LED Aufbauleuchte FLL90 6000 K</b>, 17,0 W, 1751 Lumen, EEK E</p> <p><i>mirror cabinet, 2 doors mirrored on both sides, 2 glass boards, 2 shelves incl. switch/socket, <b>LED lighting FLL90, 6000 K</b>, 17,0 W, 1751 lumen, EEC E</i></p>	150,0	68,2	13,6	<p><b>SFLSR63R</b></p> <p><b>SFLSR63RLS</b></p>  <p>Dieses Produkt enthält eine Lichtquelle der Energieeffizienzklasse E</p>	<b>2791</b>	<b>4221</b>
<p><b>Aufbauleuchte/top light</b></p>  <p>Spiegelschrank, 2 beidseitig verspiegelte Türen, 2 Glaseinlegeböden, 2 Regale inkl. Schalter/Steckdose, <b>LED Aufbauleuchte FLS90 2800-6500 K</b>, 17,5 W, 1390 Lumen, EEK G, Helligkeit dimmbar</p> <p><i>mirror cabinet, 2 doors mirrored on both sides, 2 glass boards, 2 shelves incl. switch/socket, <b>LED lighting FLS90, 2800-6500 K</b>, 17,5 W, 1390 lumen, EEC G <b>brighthness dimmable</b></i></p>	150,0	68,2	13,6	<p><b>SFLZR63R</b></p> <p><b>SFLZR63RLS</b></p>  <p>Dieses Produkt enthält eine Lichtquelle der Energieeffizienzklasse G</p>	<b>3299</b>	<b>4706</b>

EEK/EEC=Energieeffizienzklasse/energy efficiency category

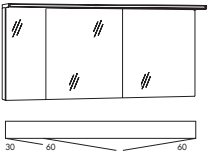
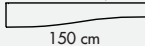

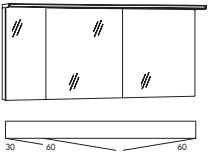



Leuchtmittel sind nicht austauschbar / illuminants are not interchangeable.

Beschreibung Description	Maße in cm Dimensions in cm			Artikel-Nr. Article no.	Türanschlag Door stop	Identnummer ID number
	B/W	H	T/D			

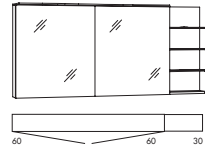
<p>Acryloberboden/ acryl top</p>  <p>Spiegelschrank, 3 beidseitig verspiegelte Türen, 6 Glaseinlegeböden, inkl. Schalter/Steckdose, <b>Acryloberboden</b> mit LED-Beleuchtung, <b>6000 K</b>, 14,5 W 1740 Lumen, EEK F</p> <p><i>mirror cabinet, 3 doors mirrored on both sides, 6 glass boards, incl. switch/socket, <b>acryl-top</b> with LED lighting, <b>6000 K</b>, 14,5 W, 1740 lumen, EEC F</i></p>	150,0 68,2 13,6	<p>Oberboden/top:</p>  <p>150 cm</p>	<p><b>SAOS366OR</b></p>  <p>Dieses Produkt enthält eine Lichtquelle der Energieeffizienzklasse F</p>	<b>2630</b>
<p>Acryloberboden/ acryl top</p>  <p>Spiegelschrank, 3 beidseitig verspiegelte Türen, 6 Glaseinlegeböden, inkl. Schalter/Steckdose, <b>Acryloberboden</b> mit LED-Beleuchtung, <b>2800-6500 K</b>, 29,0 W, 4350 Lumen, EEK F <b>Helligkeit dimmbar</b></p> <p><i>mirror cabinet, 3 doors mirrored on both sides, 6 glass boards, incl. switch/socket, <b>acryl-top</b> with LED lighting, <b>2800-6500 K</b>, 29,0 W, 4350 lumen, EEC F <b>brighness dimmable</b></i></p>	150,0 68,2 13,6	<p>Oberboden/top:</p>  <p>150 cm</p>	<p><b>SAOZ366OR</b></p>  <p>Dieses Produkt enthält eine Lichtquelle der Energieeffizienzklasse F</p>	<b>3045</b>

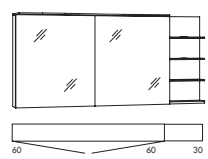
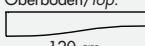

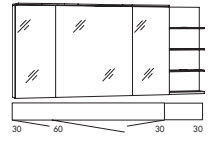
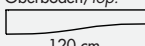



Regal (korpusfarbig) mit Glasablageböden/ shelf (basic shell coloured) with glass boards

Regal mit Spiegel und Glasablageböden (LED)/ shelf with mirror and glass boards (LED)

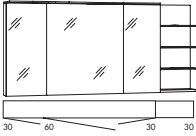
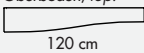
<p>Acryloberboden/ acryl top</p>  <p>Spiegelschrank, 2 beidseitig verspiegelte Türen, 4 Glaseinlegeböden, 1 Regal inkl. Schalter/Steckdose, <b>Acryloberboden</b> mit LED-Beleuchtung, <b>6000 K</b>, 11,5 W 1380 Lumen, EEK F</p> <p><i>mirror cabinet, 2 doors mirrored on both sides, 4 glass boards, 1 shelf incl. switch/socket, <b>acryl-top</b> with LED lighting, <b>6000 K</b>, 11,5 W, 1380 lumen, EEC F</i></p>	150,0 68,2 13,6	<p>Oberboden/top:</p>  <p>120 cm</p>	<p><b>SAOS66R</b></p> <p><b>SAOS66RLS</b></p>  <p>Dieses Produkt enthält eine Lichtquelle der Energieeffizienzklasse F</p>	<b>2538</b>	<b>3229</b>
<p>Acryloberboden/ acryl top</p>  <p>Spiegelschrank, 2 beidseitig verspiegelte Türen, 4 Glaseinlegeböden, 1 Regal inkl. Schalter/Steckdose, <b>Acryloberboden</b> mit LED-Beleuchtung, <b>2800-6500 K</b>, 23,0 W, 3450 Lumen, EEK F <b>Helligkeit dimmbar</b></p> <p><i>mirror cabinet, 2 doors mirrored on both sides, 4 glass boards, 1 shelf incl. switch/socket, <b>acryl-top</b> with LED lighting, <b>2800-6500 K</b>, 23,0 W, 3450 lumen, EEC F <b>brighness dimmable</b></i></p>	150,0 68,2 13,6	<p>Oberboden/top:</p>  <p>120 cm</p>	<p><b>SAOZ66R</b></p> <p><b>SAOZ66RLS</b></p>  <p>Dieses Produkt enthält eine Lichtquelle der Energieeffizienzklasse F</p>	<b>2976</b>	<b>3668</b>
<p>Acryloberboden/ acryl top</p>  <p>Spiegelschrank, 3 beidseitig verspiegelte Türen, 6 Glaseinlegeböden, 1 Regal inkl. Schalter/Steckdose, <b>Acryloberboden</b> mit LED-Beleuchtung, <b>6000 K</b>, 11,5 W 1380 Lumen, EEK F</p> <p><i>mirror cabinet, 3 doors mirrored on both sides, 6 glass boards, 1 shelf incl. switch/socket, <b>acryl-top</b> with LED lighting, <b>6000 K</b>, 11,5 W, 1380 lumen, EEC F</i></p>	150,0 68,2 13,6	<p>Oberboden/top:</p>  <p>120 cm</p>	<p><b>SAOS363R</b></p> <p><b>SAOS363RLS</b></p>  <p>Dieses Produkt enthält eine Lichtquelle der Energieeffizienzklasse F</p>	<b>2699</b>	<b>3414</b>

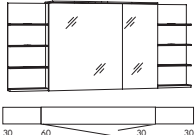
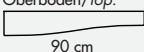
EEK/EEC=Energieeffizienzklasse/energy efficiency category  
Leuchtmittel sind nicht austauschbar / illuminants are not interchangeable.

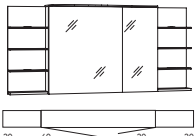
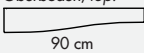
Beschreibung Description	Maße in cm Dimensions in cm			Artikel-Nr. Article no.	Türanschlag Door stop	Identnummer ID number
	B/W	H	T/D			



				Regal (korpusfarbig) mit Glasablageböden/ shelf (basic shell coloured) with glass boards	Regal mit Spiegel und Glasablageböden (LED)/shelf with mirror and glass boards (LED)
<p>Acryloberboden/ acryl top</p>  <p>Spiegelschrank, 3 beidseitig verspiegelte Türen, 6 Glaseinlegeböden, 1 Regal inkl. Schalter/Steckdose, <b>Acryloberboden</b> mit LED-Beleuchtung, <b>2800-6500 K</b>, 23,0 W, 3450 Lumen, EEK F <b>Helligkeit dimmbar</b></p> <p><i>mirror cabinet, 3 doors mirrored on both sides, 6 glass boards, 1 shelf incl. switch/socket, <b>acryl-top</b> with LED lighting, <b>2800-6500 K</b>, 23,0 W, 3450 lumen, EEC F <b>brighness dimmable</b></i></p>	150,0 68,2 13,6	<p>Oberboden/top: </p> <p>120 cm</p>	<p><b>SAOZ363R</b></p> <p><b>SAOZ363RLS</b></p>  <p>Dieses Produkt enthält eine Lichtquelle der Energieeffizienzklasse F</p>	<b>3137</b>	<b>3852</b>
<p>Acryloberboden/ acryl top</p>  <p>Spiegelschrank, 2 beidseitig verspiegelte Türen, 2 Glaseinlegeböden, 2 Regale inkl. Schalter/Steckdose, <b>Acryloberboden</b> mit LED-Beleuchtung, <b>6000 K</b>, 8,5 W 1020 Lumen, EEK F</p> <p><i>mirror cabinet, 2 doors mirrored on both sides, 2 glass boards, 2 shelves incl. switch/socket, <b>acryl-top</b> with LED lighting, <b>6000 K</b>, 8,5 W, 1020 lumen, EEC F</i></p>	150,0 68,2 13,6	<p>Oberboden/top: </p> <p>90 cm</p>	<p><b>SAOSR63R</b></p> <p><b>SAOSR63RLS</b></p>  <p>Dieses Produkt enthält eine Lichtquelle der Energieeffizienzklasse F</p>	<b>2722</b>	<b>4083</b>
<p>Acryloberboden/ acryl top</p>  <p>Spiegelschrank, 2 beidseitig verspiegelte Türen, 2 Glaseinlegeböden, 2 Regale inkl. Schalter/Steckdose, <b>Acryloberboden</b> mit LED-Beleuchtung, <b>2800-6500 K</b>, 17,0 W, 2550 Lumen, EEK F <b>Helligkeit dimmbar</b></p> <p><i>mirror cabinet, 2 doors mirrored on both sides, 2 glass boards, 2 shelves incl. switch/socket, <b>acryl-top</b> with LED lighting, <b>2800-6500 K</b>, 17,0 W, 2550 lumen, EEC F <b>brighness dimmable</b></i></p>	150,0 68,2 13,6	<p>Oberboden/top: </p> <p>90 cm</p>	<p><b>SAOZR63R</b></p> <p><b>SAOZR63RLS</b></p>  <p>Dieses Produkt enthält eine Lichtquelle der Energieeffizienzklasse F</p>	<b>3137</b>	<b>4452</b>



EEK/EEC=Energieeffizienzklasse/energy efficiency category

Leuchtmittel sind nicht austauschbar / illuminants are not interchangeable.

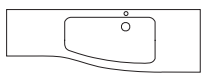
# 3160motion »150 cm L Mineralmarmor/*marble minerals*«

Beschreibung Description	Maße in cm Dimensions in cm			Artikel-Nr. Article no.	Türanschlag Door stop	Identnummer ID number
	B/W	H	T/D			

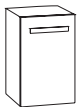
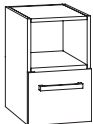
	Mineralmarmor-Waschtisch inkl. Überlauf  <i>marble minerals washbasin incl. overflow</i>	150,4	2,0	48,5/ 35,5	MNWM150L 		1209
---	---	-------	-----	---------------	---	--	------

							PG2 Matt/ <i>matt</i>	PG3 Glanz/ <i>gloss</i>
	Waschtisch-Unterschrank 2 Auszüge  <i>washbasin base cabinet 2 extensions</i>	90,0	47,8	35,1/ 48,0	MNWUG92DL		1822	1984
	Unterschrank 1 Tür, 1 Glaseinlegeboden  <i>base cabinet 1 door, 1 glass shelf</i>	30,0	47,8	35,1	MNWU30D	Links/ <i>left</i>	461	600
		30,0	47,8	48,0	MNWU30TD	Rechts/ <i>right</i>	508	646
	Unterschrank 1 Einschubregal, 1 Auszug  <i>base cabinet 1 push in shelf, 1 extension</i>	30,0	47,8	35,1	MNWUEA30D		785	969
		30,0	47,8	48,0	MNWUEA30TD		830	1016
	Unterschrank 2 Auszüge  <i>base cabinet 2 extensions</i>	30,0	47,8	35,1	MNWUA32D		854	1038
		30,0	47,8	48,0	MNWUA32TD		877	1061

<b>Aufbauleuchte/top light</b>	Spiegelschrank, 3 beidseitig verspiegelte Türen, 6 Glaseinlegeböden, inkl. Schalter/Steckdose, <b>LED Aufbauleuchte FLL90</b> <b>6000 K, 17,0 W, 1751 Lumen, EEK E</b>  <i>mirror cabinet, 3 doors mirrored on both sides, 6 glass boards, incl. switch/socket <b>LED lighting FLL90, 6000 K, 17,0 W, 1751 lumen, EEC E</b></i>	150,0	68,2	13,6	SFLS663 		2538
						Dieses Produkt enthält eine Lichtquelle der Energieeffizienzklasse E	







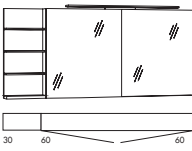

<b>Aufbauleuchte/top light</b>	Spiegelschrank, 3 beidseitig verspiegelte Türen, 6 Glaseinlegeböden, inkl. Schalter/Steckdose Steckdose, <b>LED Aufbauleuchte FLS90</b> <b>2800-6500 K, 17,5 W, 1390 Lumen,</b> <b>EEK G, Helligkeit dimmbar</b>  <i>mirror cabinet, 3 doors mirrored on both sides, 6 glass boards, incl. switch/socket <b>LED lighting FLS90, 2800-6500 K, 17,5 W, 1390 lumen, EEC G brightness dimmable</b></i>	150,0	68,2	13,6	SFLZ663 		3045
						Dieses Produkt enthält eine Lichtquelle der Energieeffizienzklasse G	

EEK/EEC=Energieeffizienzklasse/energy efficiency category

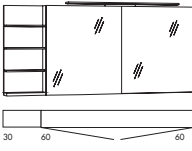
Leuchtmittel sind nicht austauschbar / illuminants are not interchangeable.

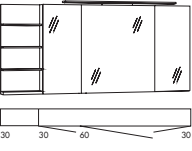
**i** Regalfarben unbedingt mit angeben, Übersicht siehe Seite 3. Please indicate shelf colours, overview see page 3.

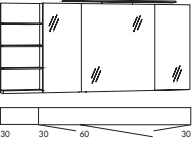



# 3160motion »150 cm L Mineralmarmor/marble minerals«

Beschreibung Description	Maße in cm Dimensions in cm			Artikel-Nr. Article no.	Türanschlag Door stop	Identnummer ID number
	B/W	H	T/D			
<p><b>Aufbauleuchte/top light</b> Spiegelschrank, 2 beidseitig verspiegelte Türen, 4 Glaseinlegeböden, 1 Regal inkl. Schalter/Steckdose, <b>LED Aufbauleuchte FLL90 6000 K</b>, 17,0 W, 1751 Lumen, EEK E</p>  <p><i>mirror cabinet, 2 doors mirrored on both sides, 4 glass boards, 1 shelf incl. switch/socket, <b>LED lighting FLL90, 6000 K, 17,0 W, 1751 lumen, EEC E</b></i></p>	150,0	68,2	13,6	<p><b>SFLSR66</b></p> <p><b>SFLSR66LS</b></p>  <p>Dieses Produkt enthält eine Lichtquelle der Energieeffizienzklasse E</p>		<p><b>2561</b></p> <p><b>3275</b></p>
<p><b>Aufbauleuchte/top light</b> Spiegelschrank, 2 beidseitig verspiegelte Türen, 4 Glaseinlegeböden, 1 Regal inkl. Schalter/Steckdose, <b>LED Aufbauleuchte FLS90 2800-6500 K</b>, 17,5 W, 1390 Lumen, EEK G, Helligkeit dimmbar</p>  <p><i>mirror cabinet, 2 doors mirrored on both sides, 4 glass boards, 1 shelf incl. switch/socket, <b>LED lighting FLS90, 2800-6500 K, 17,5 W, 1390 lumen, EEC G brightness dimmable</b></i></p>	150,0	68,2	13,6	<p><b>SFLZR66</b></p> <p><b>SFLZR66LS</b></p>  <p>Dieses Produkt enthält eine Lichtquelle der Energieeffizienzklasse G</p>		<p><b>3045</b></p> <p><b>3761</b></p>
<p><b>Aufbauleuchte/top light</b> Spiegelschrank, 3 beidseitig verspiegelte Türen, 6 Glaseinlegeböden, 1 Regal inkl. Schalter/Steckdose, <b>LED Aufbauleuchte FLL90 6000 K</b>, 17,0 W, 1751 Lumen, EEK E</p>  <p><i>mirror cabinet, 3 doors mirrored on both sides, 6 glass boards, 1 shelf incl. switch/socket, <b>LED lighting FLL90, 6000 K, 17,0 W, 1751 lumen, EEC E</b></i></p>	150,0	68,2	13,6	<p><b>SFLSR363</b></p> <p><b>SFLSR363LS</b></p>  <p>Dieses Produkt enthält eine Lichtquelle der Energieeffizienzklasse E</p>		<p><b>2745</b></p> <p><b>3460</b></p>
<p><b>Aufbauleuchte/top light</b> Spiegelschrank, 3 beidseitig verspiegelte Türen, 6 Glaseinlegeböden, 1 Regal inkl. Schalter/Steckdose, <b>LED Aufbauleuchte FLS90 2800-6500 K</b>, 17,5 W, 1390 Lumen, EEK G, Helligkeit dimmbar</p>  <p><i>mirror cabinet, 3 doors mirrored on both sides, 6 glass boards, 1 shelf incl. switch/socket, <b>LED lighting FLS90, 2800-6500 K, 17,5 W, 1390 lumen, EEC G brightness dimmable</b></i></p>	150,0	68,2	13,6	<p><b>SFLZR363</b></p> <p><b>SFLZR363LS</b></p>  <p>Dieses Produkt enthält eine Lichtquelle der Energieeffizienzklasse G</p>		<p><b>3253</b></p> <p><b>3968</b></p>

EEK/EEC=Energieeffizienzklasse/energy efficiency category

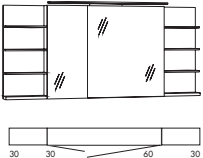

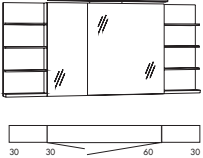

Leuchtmittel sind nicht austauschbar / illuminants are not interchangeable.





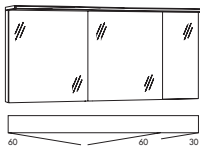

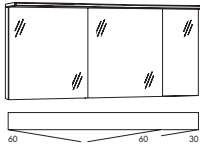
Beschreibung Description	Maße in cm Dimensions in cm			Artikel-Nr. Article no.	Türanschlag Door stop	Identnummer ID number
	B/W	H	T/D			

				Regal (korpusfarbig) mit Glasablageböden/ shelf (basic shell coloured) with glass boards	Regal mit Spiegel und Glasablageböden (LED)/ shelf with mirror and glass boards (LED)
<p><b>Aufbauleuchte/top light</b></p>  <p>Spiegelschrank, 2 beidseitig verspiegelte Türen, 2 Glaseinlegeböden, 2 Regale inkl. Schalter/Steckdose, <b>LED Aufbauleuchte FLL90</b> 6000 K, 17,0 W, 1751 Lumen, EEK E</p> <p><i>mirror cabinet, 2 doors mirrored on both sides, 2 glass boards, 2 shelves incl. switch/socket, LED lighting FLL90, 6000 K, 17,0 W, 1751 lumen, EEC E</i></p>	150,0	68,2	13,6	<p><b>SFLSR36R</b></p> <p><b>SFLSR36RLS</b></p>  <p>Dieses Produkt enthält eine Lichtquelle der Energieeffizienzklasse E</p>	<p><b>2791</b></p> <p><b>4221</b></p>
<p><b>Aufbauleuchte/top light</b></p>  <p>Spiegelschrank, 2 beidseitig verspiegelte Türen, 2 Glaseinlegeböden, 2 Regale inkl. Schalter/Steckdose, <b>LED Aufbauleuchte FLS90</b> 2800-6500 K, 17,5 W, 1390 Lumen, EEK G, Helligkeit dimmbar</p> <p><i>mirror cabinet, 2 doors mirrored on both sides, 2 glass boards, 2 shelves incl. switch/socket, LED lighting FLS90, 2800-6500 K, 17,5 W, 1390 lumen, EEC G brightness dimmable</i></p>	150,0	68,2	13,6	<p><b>SFLZR36R</b></p> <p><b>SFLZR36RLS</b></p>  <p>Dieses Produkt enthält eine Lichtquelle der Energieeffizienzklasse G</p>	<p><b>3299</b></p> <p><b>4706</b></p>

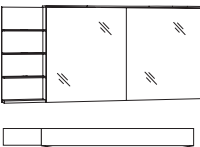
EEK/EEC=Energieeffizienzklasse/energy efficiency category  
Leuchtmittel sind nicht austauschbar / illuminants are not interchangeable.

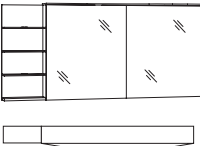
Beschreibung Description	Maße in cm Dimensions in cm			Artikel-Nr. Article no.	Türanschlag Door stop	Identnummer ID number
	B/W	H	T/D			

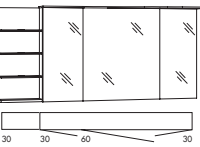
<p>Acryloberboden/ acryl top</p> 	<p>Spiegelschrank, 3 beidseitig verspiegelte Türen, 6 Glaseinlegeböden, inkl. Schalter/Steckdose, <b>Acryloberboden</b> mit LED-Beleuchtung, <b>6000 K</b>, 14,5 W 1740 Lumen, EEK F</p> <p><i>mirror cabinet, 3 doors mirrored on both sides, 6 glass boards, incl. switch/socket, <b>acryl-top</b> with LED lighting, <b>6000 K</b>, 14,5 W, 1740 lumen, EEC F</i></p>	<p>150,0 68,2 13,6</p> <p>Oberboden/top: 150 cm</p>	<p><b>SAOS663OL</b></p> 			<b>2630</b>
					Dieses Produkt enthält eine Lichtquelle der Energieeffizienzklasse F	
<p>Acryloberboden/ acryl top</p> 	<p>Spiegelschrank, 3 beidseitig verspiegelte Türen, 6 Glaseinlegeböden, inkl. Schalter/Steckdose, <b>Acryloberboden</b> mit LED-Beleuchtung, <b>2800-6500 K</b>, 29,0 W, 4350 Lumen, EEK F <b>Helligkeit dimmbar</b></p> <p><i>mirror cabinet, 3 doors mirrored on both sides, 6 glass boards, incl. switch/socket, <b>acryl-top</b> with LED lighting, <b>2800-6500 K</b>, 29,0 W, 4350 lumen, EEC F <b>brighness dimmable</b></i></p>	<p>150,0 68,2 13,6</p> <p>Oberboden/top: 150 cm</p>	<p><b>SAOZ663OL</b></p> 			<b>3045</b>
					Dieses Produkt enthält eine Lichtquelle der Energieeffizienzklasse F	







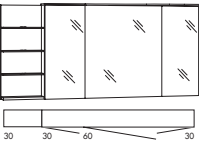
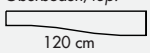

					Regal (korpusfarbig) mit Glasablageböden/ shelf (basic shell coloured) with glass boards	Regal mit Spiegel und Glasablageböden (LED)/shelf with mirror and glass boards (LED)
<p>Acryloberboden/ acryl top</p> 	<p>Spiegelschrank, 2 beidseitig verspiegelte Türen, 4 Glaseinlegeböden, 1 Regal inkl. Schalter/Steckdose, <b>Acryloberboden</b> mit LED-Beleuchtung, <b>6000 K</b>, 11,5 W 1380 Lumen, EEK F</p> <p><i>mirror cabinet, 2 doors mirrored on both sides, 4 glass boards, 1 shelf incl. switch/socket, <b>acryl-top</b> with LED lighting, <b>6000 K</b>, 11,5 W, 1380 lumen, EEC F</i></p>	<p>150,0 68,2 13,6</p> <p>Oberboden/top: 120 cm</p>	<p><b>SAOSR66</b></p> <p><b>SAOSR66LS</b></p> 			<b>2538</b>
					Dieses Produkt enthält eine Lichtquelle der Energieeffizienzklasse F	<b>3229</b>
<p>Acryloberboden/ acryl top</p> 	<p>Spiegelschrank, 2 beidseitig verspiegelte Türen, 4 Glaseinlegeböden, 1 Regal inkl. Schalter/Steckdose, <b>Acryloberboden</b> mit LED-Beleuchtung, <b>2800-6500 K</b>, 23,0 W, 3450 Lumen, EEK F <b>Helligkeit dimmbar</b></p> <p><i>mirror cabinet, 2 doors mirrored on both sides, 4 glass boards, 1 shelf incl. switch/socket, <b>acryl-top</b> with LED lighting, <b>2800-6500 K</b>, 23,0 W, 3450 lumen, EEC F <b>brighness dimmable</b></i></p>	<p>150,0 68,2 13,6</p> <p>Oberboden/top: 120 cm</p>	<p><b>SAOZR66</b></p> <p><b>SAOZR66LS</b></p> 			<b>2976</b>
					Dieses Produkt enthält eine Lichtquelle der Energieeffizienzklasse F	<b>3668</b>
<p>Acryloberboden/ acryl top</p> 	<p>Spiegelschrank, 3 beidseitig verspiegelte Türen, 6 Glaseinlegeböden, 1 Regal inkl. Schalter/Steckdose, <b>Acryloberboden</b> mit LED-Beleuchtung, <b>6000 K</b>, 11,5 W 1380 Lumen, EEK F</p> <p><i>mirror cabinet, 3 doors mirrored on both sides, 6 glass boards, 1 shelf incl. switch/socket, <b>acryl-top</b> with LED lighting, <b>6000 K</b>, 11,5 W, 1380 lumen, EEC F</i></p>	<p>150,0 68,2 13,6</p> <p>Oberboden/top: 120 cm</p>	<p><b>SAOSR363</b></p> <p><b>SAOSR363LS</b></p> 			<b>2699</b>
					Dieses Produkt enthält eine Lichtquelle der Energieeffizienzklasse F	<b>3414</b>

EEK/EEC=Energieeffizienzklasse/energy efficiency category

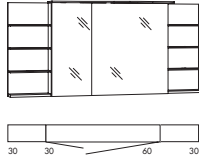
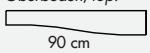
Leuchtmittel sind nicht austauschbar / illuminants are not interchangeable.

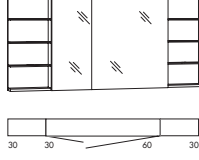
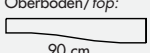

Beschreibung Description	Maße in cm Dimensions in cm			Artikel-Nr. Article no.	Türanschlag Door stop	Identnummer ID number
	B/W	H	T/D			

<p>Acryloberboden/ acryl top</p> 	<p>Spiegelschrank, 3 beidseitig verspiegelte Türen, 6 Glaseinlegeböden, 1 Regal inkl. Schalter/Steckdose, <b>Acryloberboden</b> mit LED-Beleuchtung, <b>2800-6500 K</b>, 23,0 W, 3450 Lumen, EEK F <b>Helligkeit dimmbar</b></p> <p><i>mirror cabinet, 3 doors mirrored on both sides, 6 glass boards, 1 shelf incl. switch/socket, <b>acryl-top</b> with LED lighting, <b>2800-6500 K</b>, 23,0 W, 3450 lumen, EEC F <b>brighness dimmable</b></i></p>	<p>150,0 68,2 13,6</p> <p>Oberboden/top:  120 cm</p>	<p><b>SAOZR363</b></p> <p><b>SAOZR363LS</b></p>  <p>Dieses Produkt enthält eine Lichtquelle der Energieeffizienzklasse F</p>	<p>Regal (korpusfarbig) mit Glasablageböden/ shelf (basic shell coloured) with glass boards</p>	<p>Regal mit Spiegel und Glasablageböden (LED)/shelf with mirror and glass boards (LED)</p>	<p><b>3137</b></p>	<p><b>3852</b></p>
<p>Acryloberboden/ acryl top</p> 	<p>Spiegelschrank, 2 beidseitig verspiegelte Türen, 2 Glaseinlegeböden, 2 Regal inkl. Schalter/Steckdose, <b>Acryloberboden</b> mit LED-Beleuchtung, <b>6000 K</b>, 8,5 W 1020 Lumen, EEK F</p> <p><i>mirror cabinet, 2 doors mirrored on both sides, 2 glass boards, 2 shelves incl. switch/socket, <b>acryl-top</b> with LED lighting, <b>6000 K</b>, 8,5 W, 1020 lumen, EEC F</i></p>	<p>150,0 68,2 13,6</p> <p>Oberboden/top:  90 cm</p>	<p><b>SAOSR36R</b></p> <p><b>SAOSR36RLS</b></p>  <p>Dieses Produkt enthält eine Lichtquelle der Energieeffizienzklasse F</p>	<p><b>2722</b></p>	<p><b>4083</b></p>		
<p>Acryloberboden/ acryl top</p> 	<p>Spiegelschrank, 2 beidseitig verspiegelte Türen, 2 Glaseinlegeböden, 2 Regale inkl. Schalter/Steckdose, <b>Acryloberboden</b> mit LED-Beleuchtung, <b>2800-6500 K</b>, 17,0 W, 2550 Lumen, EEK F <b>Helligkeit dimmbar</b></p> <p><i>mirror cabinet, 2 doors mirrored on both sides, 2 glass boards, 2 shelves incl. switch/socket, <b>acryl-top</b> with LED lighting, <b>2800-6500 K</b>, 17,0 W, 2550 lumen, EEC F <b>brighness dimmable</b></i></p>	<p>150,0 68,2 13,6</p> <p>Oberboden/top:  90 cm</p>	<p><b>SAOZR36R</b></p> <p><b>SAOZR36RLS</b></p>  <p>Dieses Produkt enthält eine Lichtquelle der Energieeffizienzklasse F</p>	<p><b>3137</b></p>	<p><b>4452</b></p>		
	<p>Steckdose/Powerbox für Spiegelschränke Ausführung <b>Schweiz</b> IP44 mit USB-C Stecker</p> <p><i>Power socket for mirror cabinets <b>Switzerland</b> type IP44 with USB-C plug</i></p>		<p><b>Mehrpreis extra charge</b></p>		<p><b>138</b></p>		
	<p>Steckdose/Powerbox für Spiegelschränke Ausführung <b>Frankreich</b> mit USB-C Stecker</p> <p><i>Power socket for mirror cabinets <b>France</b> type with USB-C plug</i></p>		<p><b>Mehrpreis extra charge</b></p>		<p><b>138</b></p>		

EEK/EEC=Energieeffizienzklasse/energy efficiency category  
Leuchtmittel sind nicht austauschbar / illuminants are not interchangeable.

**i** Weiteres Zubehör finden Sie im Register 3970 und Beistellschränke im Register 3990.  
*Further accessoires can be found in register 3970 and side cabinets in register 3990.*





# 3250star

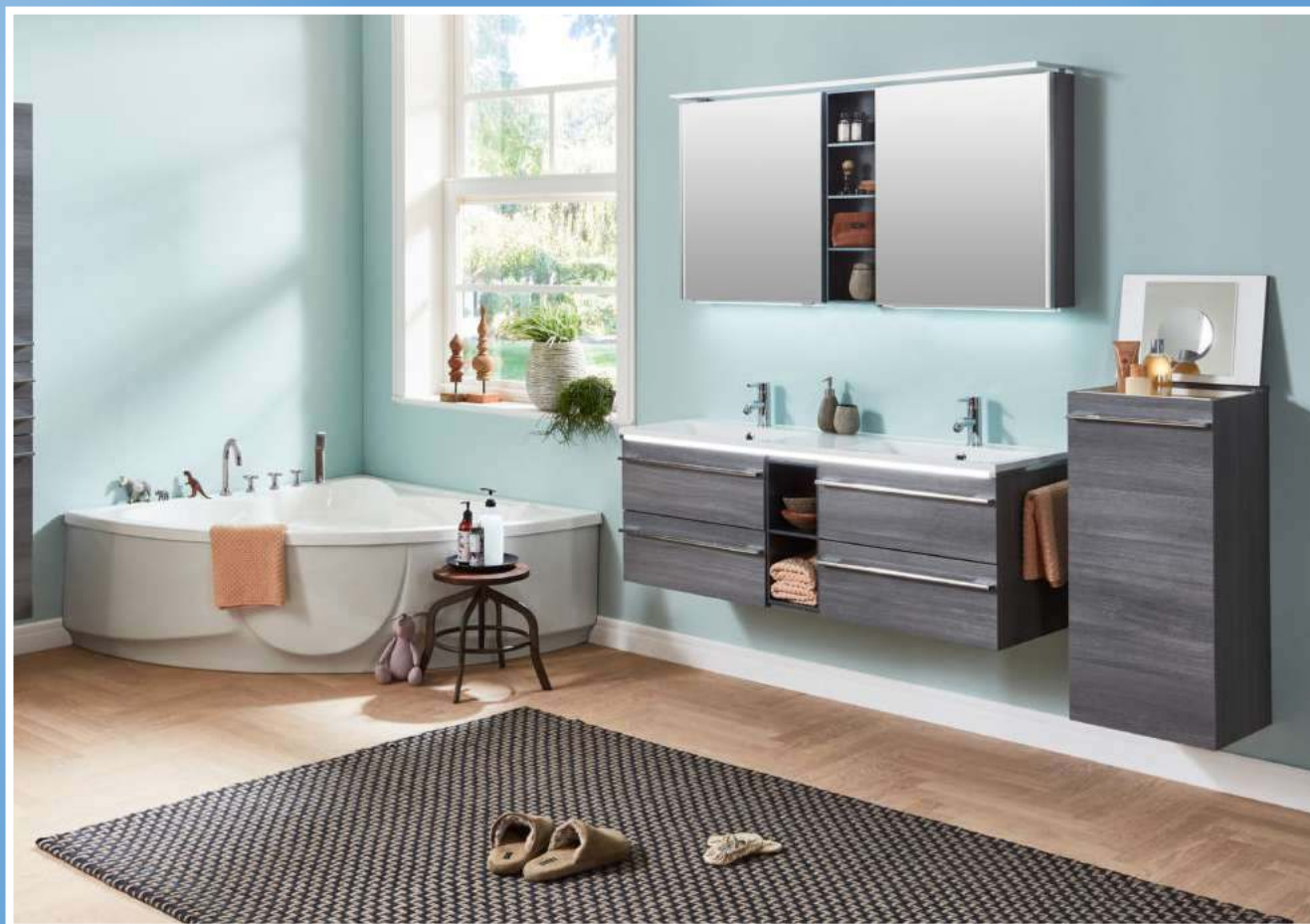



# »3250star«

Piktogramme/pictograms



Mineralmarmor Waschtisch  
Marble minerals washbasin



LED Lichtfarbe kalt  
LED colour temperature cold



LED mit Bewegungssensor  
LED with motion sensor



LED Lichtfarbe warm  
LED colour temperature warm



LED mit Sensorschalter,  
Helligkeit dimmbar  
LED with sensor switch,  
brightness dimmable

## Mineralmarmor Waschtisch weiß alpin Glanz (SH69) Marble minerals washbasin gloss alpine white (SH69)

≈ Beckenmaße in cm (BxHxT)  
basin dimensions in cm (WxHxD)

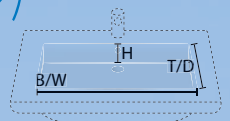

MWSTA6R | 38 x 10 x 24 cm  
MWSTAL6R | 38 x 10 x 24 cm\*



MWSTA6 | 55 x 12 x 28 cm  
MWSTAL6 | 55 x 12 x 28 cm\*



Detail



MWSTA8L | 55 x 12 x 28 cm  
MWSTAL8L | 55 x 12 x 28 cm\*



MWSTA8R | 55 x 12 x 28 cm  
MWSTAL8R | 55 x 12 x 28 cm\*



MWSTA10L | 55 x 12 x 28 cm  
MWSTAL10L | 55 x 12 x 28 cm\*



MWSTA10R | 55 x 12 x 28 cm  
MWSTAL10R | 55 x 12 x 28 cm\*



MWSTA14D | 55 x 12 x 28 cm  
MWSTAL14D | 55 x 12 x 28 cm\*



\* (L) mit LED-Beleuchtung  
(L) with LED-lighting

## Schränke/cabinets 3250star

### Frontfarben/front colours

#### Dickkante/thick edge

286



**Weiß Seidenglanz**  
Silk Gloss White  
SHE\_

284



**Anthrazit Seidenglanz**  
Silk Gloss Anthracite  
SHA\_

490



**Kastanie Graphit Nachbildung**  
Graphite Chestnut Finish  
SHC\_

473



**Eiche Struktur Natur Nachbildung**  
Oak Structure Nature Finish  
SHM\_

435



**Eiche Struktur Weiß Nachbildung** NEW  
Oak Structure White Finish  
SHL\_

426



**Eiche Struktur Braun Nachbildung** NEW  
Oak Structure Brown Finish  
SHH\_

#### MDF-foliert/MDF-coated

961



**Weiß Glanz**  
Gloss White  
SHG\_

438



**Anthrazit Glanz**  
Gloss Anthracite  
SHF\_

### Korpusfarben/basic shell colours

#### PG 1 Dickkante/thick edge

286



**Weiß Seidenglanz**  
Silk Gloss White  
E/SH86

284



**Anthrazit Seidenglanz**  
Silk Gloss Anthracite  
A/SH84

490



**Kastanie Graphit Nachbildung**  
Graphite Chestnut Finish  
C/SH45

473



**Eiche Struktur Natur Nachbildung**  
Oak Structure Nature Finish  
M/SH55

435



**Eiche Struktur Weiß Nachbildung** NEW  
Oak Structure White Finish  
L/SH40

426



**Eiche Struktur Braun Nachbildung** NEW  
Oak Structure Brown Finish  
H/SH70

#### PG 3 MDF-foliert/MDF-coated

042



**Weiß Glanz Folie**  
Gloss White  
G/SH50

438









**Anthrazit Glanz Folie**  
Gloss Anthracite  
F/SH30

#### ! BITTE BEACHTEN:



Die Front-/Korpuskombination „MDF-folierte FRONT (Variante: 961/438)“ mit „Korpus PG1 (Variante: 284/286/426/435/473/490)“ wird zu PG2 abgerechnet.

The front / basic shell combination „MDF-foiled front (variant: 961/438)“ with „basic shell PG1 (variant: 284/286/426/435/473/490)“ is billed to PG2.

## Regalfarben/ shelf colours

287		<b>Weiß Seidenglanz</b> <i>Silk Gloss White</i> SH86	285		<b>Anthrazit Seidenglanz</b> <i>Silk Gloss Anthracite</i> SH84
491		<b>Kastanie Graphit Nachbildung</b> <i>Graphite Chestnut Finish</i> SH45	474		<b>Eiche Struktur Natur Nachbildung</b> <i>Oak Structure Nature Finish</i> SH55
436		<b>Eiche Struktur Weiß Nachbildung</b> <span style="background-color: #0070C0; color: white; padding: 2px;">NEW</span> <i>Oak Structure White Finish</i> SH40	427		<b>Eiche Struktur Braun Nachbildung</b> <span style="background-color: #0070C0; color: white; padding: 2px;">NEW</span> <i>Oak Structure Brown Finish</i> SH70

## Griffe/handles

	<b>Chrom Glanz</b> <i>Gloss Chrome</i> Griffnummer/handlenumber: 398/384/379/380/381/382 ⌀-⌀ 166 mm/184 mm/284 mm/483 mm/342-342 mm*/442-442 mm*
	<b>Schwarz Matt Struktur</b> <span style="background-color: #0070C0; color: white; padding: 2px;">NEW</span> <i>Matt Black Structure</i> Griffnummer/handlenumber: 272/273/271/274/275/276/277 ⌀-⌀ 96 mm/128 mm/192 mm/256 mm/179-179 mm*/179-179 mm*/279-279 mm*

⌀-⌀ = Bohrabstand/hole spacing      \*drei Grifflochbohrungen















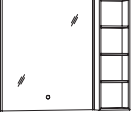

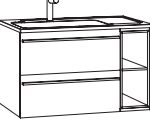

Die Angabe einer Griffnummer ist ausreichend. Die Griffe werden passend zur jeweiligen Schrankbreite beigelegt.  
The indication of one handle number is sufficient. The handles are supplied to match the respective cabinet width.

## Beleuchtung / lighting

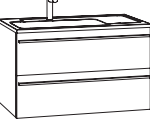
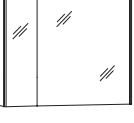
	<b>Aufbauleuchte LED</b> <i>Top light LED</i>	<b>Lichtfarbe Tageslicht (Kalt)</b> <i>Luminous colour natural light (cold)</i>
		 AW60, AWP60, AW80, AWP80 AW100, AWP100, AW140, AWP140

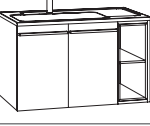
Die Steckdose / Powerbox für Spiegelschränke ist auch in Ausführung für die Schweiz / Frankreich erhältlich. Bitte Mehrpreis beachten (siehe Seite 16).  
The power socket for mirror cabinets is also available for Switzerland / France. Please note extra charge (see page 16).



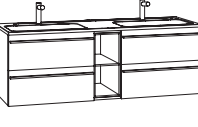

# 3250star »Beispiel-Kombinationen/example-combinations«

Beschreibung Description	Maße in cm Dimensions in cm			Artikel-Nr. Article no.	Türanschlag Door stop	Identnummer ID number		
	B/W	H	T/D			PG1	PG2	PG3
 <p>Kombination 60 cm bestehend aus: Spiegelpaneel, Sensorschalter Mineralmarmor-Waschtisch Waschtisch-Unterschrank, 2 Türen <b>Gästebad-Kombi, 30 cm Tiefe</b></p>				<b>SPBSA6</b> <b>MWSTA6R</b> <b>WMKT6</b>	  	1107 692 624	1107 692 692	1107 692 761
 <p>combination 60 cm width consisting of: mirror panel, sensor switch marble minerals washbasin washbasin base cabinet, 2 doors <b>Guest bathroom combination, 30 cm depth</b></p>						2423	2491	2560
 <p>Kombination 80 cm bestehend aus: Spiegelpaneel, Sensorschalter Regal neben dem Spiegelpaneel Mineralmarmor-Waschtisch Waschtisch-Unterschrank, 2 Auszüge, 1 Einschubregal</p>				<b>SPBSA6</b> <b>REA20</b> <b>MWSTA8R</b> <b>WMKAAE8</b>	  	1107 372 992 1591	1107 372 992 1697	1107 372 992 1799
 <p>combination 80 cm width consisting of: mirror panel, sensor switch side shelf adjacent to mirror cabinet marble minerals washbasin washbasin base cabinet, 2 extensions, 1 push-in shelf</p>						4062	4168	4270
 <p>Kombination 80 cm bestehend aus: Spiegelschrank, seitliche LED-Beleuchtung Mineralmarmor-Waschtisch Waschtisch-Unterschrank, 2 Auszüge</p>				<b>SAD8L</b> <b>MWSTA8R</b> <b>WMKAA8SL</b>	 	1684 992 1360	1684 992 1446	1684 992 1552
 <p>combination 80 cm width consisting of: mirror cabinet, lateral LED-lighting marble minerals washbasin washbasin base cabinet, 2 extensions</p>						4036	4122	4228
 <p>Kombination 80 cm bestehend aus: Spiegelschrank, seitliche LED-Beleuchtung Mineralmarmor-Waschtisch Waschtisch-Unterschrank, 2 Türen, 1 Einschubregal</p>				<b>SAD8R</b> <b>MWSTA8R</b> <b>WMKTE8</b>	 	1684 992 1107	1684 992 1223	1684 992 1338
 <p>combination 80 cm width consisting of: mirror cabinet, lateral LED-lighting marble minerals washbasin, depot right washbasin base cabinet, 2 doors, 1 push-in shelf</p>						3783	3899	4014
 <p>Kombination 140 cm bestehend aus: Spiegelschrank, seitliche LED-Beleuchtung, 1 Regal mittig Mineralmarmor-Doppelwaschtisch Waschtisch-Unterschrank, 4 Auszüge, 1 Einschubregal</p>				<b>SADR14</b> <b>MWSTA14D</b> <b>WMKAE14</b>	 	2860 1453 2722	2860 1453 2929	2860 1453 3045
 <p>combination 140 cm width consisting of: mirror cabinet, lateral LED-lighting, 1 shelf marble minerals double washbasin washbasin base cabinet, 4 extensions, 1 push-in shelf</p>						7035	7242	7358

Handtuchhalter, Regale, Unterbaubeleuchtungen und weiteres Zubehör finden Sie in der Rubrik 3970zubehör.  
Towel rails, shelves, base lightings and other accessories can be found in the 3970accessories range.

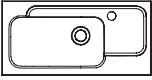
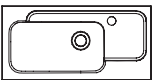
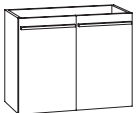
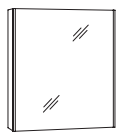

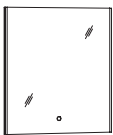







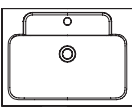

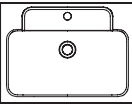



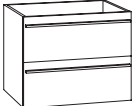
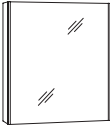

# 3250star »60 cm GÄSTEBAD Mineralmarmor/ marble minerals«

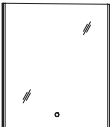
Beschreibung Description	Maße in cm Dimensions in cm			Artikel-Nr. Article no.	Türanschlag	Identnummer ID number		
	B/W	H	T/D					
 <p>Mineralmarmor-Waschtisch <b>Ablage rechts</b> inkl. Permanentablauf</p> <p><i>marble minerals washbasin depot on the right incl. permanent flow</i></p>	60,5	2,0	30,0	<b>MWSTA6R</b>		<b>692</b>		
 <p>Mineralmarmor-Waschtisch <b>Ablage rechts, inkl. Permanentablauf mit LED-Beleuchtung und Bewegungssensor, 6000 K, 5,3 W, 413 Lumen, EEK G</b></p> <p><i>marble minerals washbasin depot on the right, incl. permanent flow with LED-lighting and motion sensor 6000 K, 5,3 W, 413 lumen, EEC G</i></p>	60,5	3,4	30,0	<b>MWSTAL6R</b>		<b>1085</b>		
						PG1	PG2	PG3
 <p>Waschtisch-Unterschrank 2 Türen</p> <p><i>washbasin base cabinet 2 doors</i></p>	60,0	47,8	29,5	<b>WMKT6</b>		<b>624</b>	<b>692</b>	<b>761</b>
 <p>Spiegelschrank, 1 beidseitig verspiegelte Tür, 2 Glaseinlegeböden, inkl. Schalter/Steckdose, seitliche LED-Beleuchtung, 6000 K, 2x 6,3 W, 2x 660 Lumen, EEK F</p> <p><i>mirror cabinet, 1 door mirrored on both sides, 2 glass boards, incl. switch/socket lateral LED-lighting, 6000 K, 2x 6,3 W, 2x 660 lumen, EEC F</i></p>	60,0	68,2	13,6	<b>SAD6</b>	<b>L/R</b>	<b>1338</b>		
 <p>LED-Aufbauleuchte für Spiegelschrank mit LED-Mini-Stecker, 6000 K, 8,2 W, 1026 Lumen, EEK E</p> <p><i>LED-lighting for mirror cabinet with LED-mini-plug, 6000 K, 8,2 W, 1026 lumen, EEC E</i></p>	60,0	2,4	20,0	<b>AW60</b>		<b>370</b>		
 <p>Spiegelpaneel, Sensorschalter, seitliche LED-Beleuchtung 6000 K, 2x 6,3 W, 2x 660 Lumen, EEK F <b>Helligkeit dimmbar</b></p> <p><i>mirror panel, sensor switch, lateral LED-lighting 6000 K, 2x 6,3 W, 2x 660 lumen, EEC F brighness dimmable</i></p>	60,0	68,2	2,8	<b>SPBSA6</b>		<b>1107</b>		
 <p>LED-Aufbauleuchte für Spiegelpaneel mit LED-Mini-Stecker, 6000 K, 8,6 W, 792 Lumen, EEK E <b>Helligkeit dimmbar</b></p> <p><i>LED-lighting for mirror panel with LED-mini-plug, 6000 K, 8,6 W, 792 lumen, EEC E brighness dimmable</i></p>	60,0	2,4	10,0	<b>AWP60</b>		<b>323</b>		

EEK/EEC=Energieeffizienzklasse/energy efficiency category  
Leuchtmittel sind nicht austauschbar / illuminants are not interchangeable.

# 3250star »60 cm Mineralmarmor/marble minerals«







Beschreibung Description	Maße in cm Dimensions in cm			Artikel-Nr. Article no.	Türanschlag Door stop	Identnummer ID number		
	B/W	H	T/D					
 <p>Mineralmarmor-Waschtisch inkl. Überlauf <i>marble minerals washbasin incl. overflow</i></p>	60,5	2,0	45,0	<b>MWSTA6</b> 		<b>761</b>		
 <p>Mineralmarmor-Waschtisch inkl. Überlauf <b>mit LED-Beleuchtung und Bewegungs- sensor, 6000 K, 5,3 W, 413 Lumen, EEK G</b> <i>marble minerals washbasin incl. overflow with LED-lighting and motion sensor 6000 K, 5,3 W, 413 lumen, EEC G</i></p>	60,5	3,4	45,0	<b>MWSTAL6</b>   		<b>1154</b>		
						PG1	PG2	PG3
 <p>Waschtisch-Unterschrank 2 Türen <i>washbasin base cabinet 2 doors</i></p>	60,0	47,8	44,5	<b>WMKTT6</b>		<b>670</b>	<b>761</b>	<b>877</b>
 <p>Waschtisch-Unterschrank 2 Auszüge <i>washbasin base cabinet 2 extensions</i></p>	60,0	47,8	44,5	<b>WMKAA6</b>		<b>1164</b>	<b>1245</b>	<b>1361</b>
 <p>Spiegelschrank, 1 beidseitig verspiegelte Tür, 2 Glaseinlegeböden, inkl. Schalter/ Steckdose, seitliche LED-Beleuchtung, 6000 K, 2x 6,3 W, 2x 660 Lumen, EEK F <i>mirror cabinet, 1 door mirrored on both sides, 2 glass boards, incl. switch/socket lateral LED-lighting, 6000 K, 2x 6,3 W, 2x 660 lumen, EEC F</i></p>	60,0	68,2	13,6	<b>SAD6</b> 	L/R	<b>1338</b>		
 <p>LED-Aufbauleuchte für Spiegelschrank mit LED-Mini-Stecker, 6000 K, 8,2 W, 1026 Lumen, EEK E <i>LED-lighting for mirror cabinet with LED-mini-plug, 6000 K, 8,2 W, 1026 lumen, EEC E</i></p>	60,0	2,4	20,0	<b>AW60</b> 		<b>370</b>		
 <p>Spiegelpaneel, Sensorschalter, seitliche LED-Beleuchtung 6000 K, 2x 6,3 W, 2x 660 Lumen, EEK F <b>Helligkeit dimmbar</b> <i>mirror panel, sensor switch, lateral LED-lighting 6000 K, 2x 6,3 W, 2x 660 lumen, EEC F brightness dimmable</i></p>	60,0	68,2	2,8	<b>SPBSA6</b>  		<b>1107</b>		
 <p>LED-Aufbauleuchte für Spiegelpaneel mit LED-Mini-Stecker, 6000 K, 8,6 W, 792 Lumen, EEK E <b>Helligkeit dimmbar</b> <i>LED-lighting for mirror panel with LED-mini-plug, 6000 K, 8,6 W, 792 lumen, EEC E brightness dimmable</i></p>	60,0	2,4	10,0	<b>AWP60</b>  		<b>323</b>		



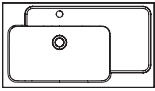

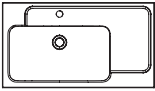
EEK/EEC=Energyeffizienzklasse/energy efficiency category

Leuchtmittel sind nicht austauschbar / illuminants are not interchangeable.

# 3250star »80 cm R Mineralmarmor/*marble minerals*«

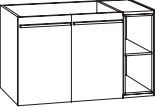
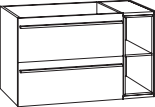
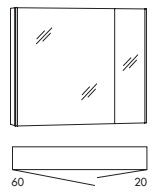
Beschreibung Description	Maße in cm Dimensions in cm			Artikel-Nr. Article no.	Türanschlag	Identnummer ID number
	B/W	H	T/D			







	Mineralmarmor-Waschtisch <b>Ablage rechts</b> inkl. Überlauf  <i>marble minerals washbasin depot on the right</i> incl. overflow	80,5	2,0	45	<b>MWSTA8R</b> 	<b>992</b>
	Mineralmarmor-Waschtisch <b>Ablage rechts</b> inkl. Überlauf <b>mit LED-Beleuchtung und Bewegungs-</b> <b>sensor, 6000 K, 7,2 W, 562 Lumen, EEK G</b>  <i>marble minerals washbasin depot on the right, incl. overflow with LED-lighting and motion sensor 6000 K, 7,2 W, 562 lumen, EEC G</i>	80,5	3,4	45	<b>MWSTAL8R</b>     Dieses Produkt enthält eine Lichtquelle der Energieeffizienzklasse G	<b>1431</b>

						PG1	PG2	PG3
	Waschtisch-Unterschrank 2 Auszüge, <b>Ausschnitt Siphon links</b>  <i>washbasin base cabinet 2 extensions, cutout siphon left</i>	80,0	47,8	44,5	<b>WMKAA8SL</b>	<b>1360</b>	<b>1446</b>	<b>1552</b>
	Waschtisch-Unterschrank 2 Türen, <b>1 Einschubregal rechts</b>  <i>washbasin base cabinet 2 doors, 1 push-in shelf right</i>	80,0	47,8	44,5	<b>WMKTE8</b>	<b>1107</b>	<b>1223</b>	<b>1338</b>
	Waschtisch-Unterschrank 2 Auszüge, <b>1 Einschubregal rechts</b>  <i>washbasin base cabinet 2 extensions, 1 push-in shelf right</i>	80,0	47,8	44,5	<b>WMKAAE8</b>	<b>1591</b>	<b>1697</b>	<b>1799</b>
	Spiegelschrank, 2 beidseitig verspiegelte Türen, 2 Glaseinlegeböden, inkl. Schalter/ Steckdose, seitliche LED-Beleuchtung, 6000 K, 2x 6,3 W, 2x 660 Lumen, EEK F  <i>mirror cabinet, 2 doors mirrored on both sides, 2 glass boards, incl. switch/socket lateral LED-lighting, 6000 K, 2x 6,3 W, 2x 660 lumen, EEC F</i>	80,0	68,2	13,6	<b>SAD8L</b>   Dieses Produkt enthält eine Lichtquelle der Energieeffizienzklasse F	<b>1684</b>		
	LED-Aufbauleuchte für Spiegelschrank mit LED-Mini-Stecker, 6000 K, 10,8 W, 1350 Lumen, EEK E  <i>LED-lighting for mirror cabinet with LED-mini-plug, 6000 K, 10,8 W, 1350 lumen, EEC E</i>	80,0	2,4	20,0	<b>AW80</b>   Dieses Produkt enthält eine Lichtquelle der Energieeffizienzklasse E	<b>415</b>		

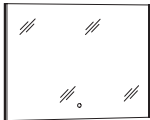
EEK/EEC=Energieeffizienzklasse/energy efficiency category  
Leuchtmittel sind nicht austauschbar / illuminants are not interchangeable.





 Regalfarben unbedingt mit angeben, Übersicht siehe Seite 3. Please indicate shelf colours, overview see page 3.

# 3250star »80 cm R Mineralmarmor/*marble minerals*«

Beschreibung <i>Description</i>	Maße in cm <i>Dimensions in cm</i>			Artikel-Nr. <i>Article no.</i>	Türanschlag <i>Door stop</i>	Identnummer <i>ID number</i>
	B/W	H	T/D			
 <p>Spiegelpaneel, Sensorschalter, seitliche LED-Beleuchtung 6000 K, 2x 6,3 W, 2x 660 Lumen, EEK F <b>Helligkeit dimmbar</b></p> <p><i>mirror panel, sensor switch, lateral LED-lighting 6000 K, 2x 6,3 W, 2x 660 lumen, EEC F</i> <b>brighthness dimmable</b></p>	80,0	68,2	2,8	<b>SPBSA8</b>   Dieses Produkt enthält eine Lichtquelle der Energieeffizienzklasse F		1154
 <p>LED-Aufbauleuchte für Spiegelpaneel mit LED-Mini-Stecker, 6000 K, 10,8 W, 1350 Lumen, EEK E <b>Helligkeit dimmbar</b></p> <p><i>LED-lighting for mirror panel with LED-mini-plug, 6000 K, 10,8 W, 1350 lumen, EEC E</i> <b>brighthness dimmable</b></p>	80,0	2,4	10,0	<b>AWP80</b>   Dieses Produkt enthält eine Lichtquelle der Energieeffizienzklasse E		370

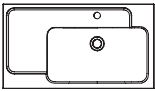
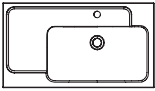
EEK/EEC=Energieeffizienzklasse/energy efficiency category  
Leuchtmittel sind nicht austauschbar / *illuminants are not interchangeable.*

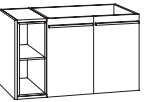
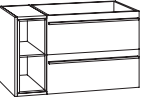
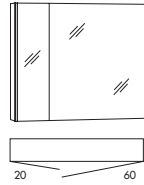





# 3250star »80 cm L Mineralmarmor/marble minerals «

Beschreibung Description	Maße in cm Dimensions in cm			Artikel-Nr. Article no.	Türanschlag	Identnummer ID number			
	B/W	H	T/D						
 <p>Mineralmarmor-Waschtisch <b>Ablage links</b> inkl. Überlauf <i>marble minerals washbasin depot on the left incl. overflow</i></p>	80,5	2,0	45	<b>MWSTA8L</b>		<b>992</b>			
 <p>Mineralmarmor-Waschtisch <b>Ablage links</b>, inkl. Überlauf <b>mit LED-Beleuchtung und Bewegungs- sensor</b>, 6000 K, 7,2 W, 562 Lumen, EEK G <i>marble minerals washbasin depot on the left, incl. overflow with LED-lighting and motion sensor 6000 K, 7,2 W, 562 lumen, EEC G</i></p>	80,5	3,4	45	<b>MWSTA8L</b>		<b>1431</b>			
							PG1	PG2	PG3
 <p>Waschtisch-Unterschrank 2 Auszüge, <b>Ausschnitt Siphon rechts</b> <i>washbasin base cabinet 2 extensions, cutout siphon right</i></p>	80,0	47,8	44,5	<b>WMKAA8SR</b>		<b>1360</b>	<b>1446</b>	<b>1552</b>	
 <p>Waschtisch-Unterschrank 2 Türen, <b>1 Einschubregal links</b> <i>washbasin base cabinet 2 doors, 1 push-in shelf left</i></p>	80,0	47,8	44,5	<b>WMKETT8</b>		<b>1107</b>	<b>1223</b>	<b>1338</b>	
 <p>Waschtisch-Unterschrank 2 Auszüge, <b>1 Einschubregal links</b> <i>washbasin base cabinet 2 extensions, 1 push-in shelf left</i></p>	80,0	47,8	44,5	<b>WMKEAA8</b>		<b>1591</b>	<b>1697</b>	<b>1799</b>	
 <p>Spiegelschrank, 2 beidseitig verspiegelte Türen, 2 Glaseinlegeböden, inkl. Schalter/ Steckdose, seitliche LED-Beleuchtung, 6000 K, 2x 6,3 W, 2x 660 Lumen, EEK F <i>mirror cabinet, 2 doors mirrored on both sides, 2 glass boards, incl. switch/socket lateral LED-lighting, 6000 K, 2x 6,3 W, 2x 660 lumen, EEC F</i></p>	80,0	68,2	13,6	<b>SAD8R</b>		<b>1684</b>			
 <p>LED-Aufbauleuchte für Spiegelschrank mit LED-Mini-Stecker, 6000 K, 10,8 W, 1350 Lumen, EEK E <i>LED-lighting for mirror cabinet with LED-mini-plug, 6000 K, 10,8 W, 1350 lumen, EEC E</i></p>	80,0	2,4	20,0	<b>AW80</b>		<b>415</b>			

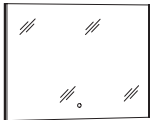
EEK/EEC=Energieeffizienzklasse/energy efficiency category  
Leuchtmittel sind nicht austauschbar / illuminants are not interchangeable.

**i** Regalfarben unbedingt mit angeben, Übersicht siehe Seite 3. Please indicate shelf colours, overview see page 3.











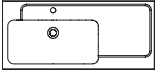

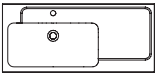

# 3250star »80 cm L Mineralmarmor/*marble minerals* «

Beschreibung <i>Description</i>	Maße in cm <i>Dimensions in cm</i>			Artikel-Nr. <i>Article no.</i>	Türanschlag <i>Door stop</i>	Identnummer <i>ID number</i>
	B/W	H	T/D			
 <p>Spiegelpanel, Sensorschalter, seitliche LED-Beleuchtung 6000 K, 2x 6,3 W, 2x 660 Lumen, EEK F <b>Helligkeit dimmbar</b></p> <p><i>mirror panel, sensor switch, lateral LED-lighting 6000 K, 2x 6,3 W, 2x 660 lumen, EEC F</i> <b>brighness dimmable</b></p>	80,0	68,2	2,8	<b>SPBSA8</b>   Dieses Produkt enthält eine Lichtquelle der Energieeffizienzklasse F		1154
 <p>LED-Aufbauleuchte für Spiegelpanel mit LED-Mini-Stecker, 6000 K, 10,8 W, 1350 Lumen, EEK E <b>Helligkeit dimmbar</b></p> <p><i>LED-lighting for mirror panel with LED-mini-plug, 6000 K, 10,8 W, 1350 lumen, EEC E</i> <b>brighness dimmable</b></p>	80,0	2,4	10,0	<b>AWP80</b>   Dieses Produkt enthält eine Lichtquelle der Energieeffizienzklasse E		370

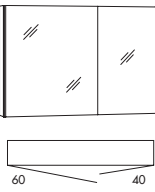
EEK/EEC=Energieeffizienzklasse/energy efficiency category  
Leuchtmittel sind nicht austauschbar / *illuminants are not interchangeable.*

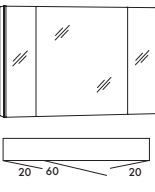

# 3250star »100 cm R Mineralmarmor/*marble minerals*«

Beschreibung Description	Maße in cm Dimensions in cm			Artikel-Nr. Article no.	Türanschlag	Identnummer ID number
	B/W	H	T/D			

	Mineralmarmor-Waschtisch <b>Ablage rechts</b> inkl. Überlauf <i>marble minerals washbasin depot on the right incl. overflow</i>	100,5	2,0	45,0	<b>MWSTA10R</b> 		<b>1131</b>	
	Mineralmarmor-Waschtisch <b>Ablage rechts</b> inkl. Überlauf <b>mit LED-Beleuchtung und Bewegungssensor</b> , 6000 K, 9,1 W, 706 Lumen, EEK G <i>marble minerals washbasin depot on the right, incl. overflow with LED-lighting and motion sensor 6000 K, 9,1 W, 706 lumen, EEC G</i>	100,5	3,4	45,0	<b>MWSTA10R</b>    Dieses Produkt enthält eine Lichtquelle der Energieeffizienzklasse G		<b>1591</b>	
						PG1	PG2	PG3
	Waschtisch-Unterschrank 2 Auszüge, <b>Ausschnitt Siphon links</b> <i>washbasin base cabinet 2 extensions, cutout siphon left</i>	100,0	47,8	44,5	<b>WMKAA10SL</b>	<b>1476</b>	<b>1615</b>	<b>1730</b>
	Waschtisch-Unterschrank 2 Auszüge, <b>1 Einschubregal rechts</b> <i>washbasin base cabinet 2 extensions, 1 push-in shelf right</i>	100,0	47,8	44,5	<b>WMKAAE10</b>	<b>1777</b>	<b>1892</b>	<b>2007</b>
	Spiegelschrank, 2 beidseitig verspiegelte Türen, 2 Glaseinlegeböden, inkl. Schalter/Steckdose, seitliche LED-Beleuchtung, 6000 K, 2x 6,3 W, 2x 660 Lumen, EEK F <i>mirror cabinet, 2 doors mirrored on both sides, 2 glass boards, incl. switch/socket lateral LED-lighting, 6000 K, 2x 6,3 W, 2x 660 lumen, EEC F</i>	100,0	68,2	13,6	<b>SAD10L</b>  Dieses Produkt enthält eine Lichtquelle der Energieeffizienzklasse F		<b>1776</b>	
	Spiegelschrank, 3 beidseitig verspiegelte Türen, 4 Glaseinlegeböden, inkl. Schalter/Steckdose, seitliche LED-Beleuchtung, 6000 K, 2x 6,3 W, 2x 660 Lumen, EEK F <i>mirror cabinet, 3 doors mirrored on both sides, 4 glass boards, incl. switch/socket lateral LED-lighting, 6000 K, 2x 6,3 W, 2x 660 lumen, EEC F</i>	100,0	68,2	13,6	<b>SAD10A</b>  Dieses Produkt enthält eine Lichtquelle der Energieeffizienzklasse F		<b>2007</b>	
	LED-Aufbauleuchte für Spiegelschrank mit LED-Mini-Stecker, ohne Schalter, 6000 K, 13,8 W, 1728 Lumen, EEK E <i>LED-lighting for mirror cabinet with LED-mini-plug, without switch, 6000 K, 13,8 W, 1728 lumen, EEC E</i>	100,0	2,4	20,0	<b>AW100</b>  Dieses Produkt enthält eine Lichtquelle der Energieeffizienzklasse E		<b>461</b>	

EEK/EEC=Energieeffizienzklasse/energy efficiency category  
Leuchtmittel sind nicht austauschbar / illuminants are not interchangeable.

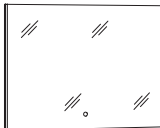
 Regalfarben unbedingt mit angeben, Übersicht siehe Seite 3. Please indicate shelf colours, overview see page 3.











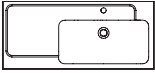

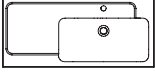
Beschreibung <i>Description</i>	Maße in cm <i>Dimensions in cm</i>			Artikel-Nr. <i>Article no.</i>	Türanschlag <i>Door stop</i>	Identnummer <i>ID number</i>
	B/W	H	T/D			
 <p>Spiegelpanel, Sensorschalter, seitliche LED-Beleuchtung 6000 K, 2x 6,3 W, 2x 660 Lumen, EEK F <b>Helligkeit dimmbar</b></p> <p><i>mirror panel, sensor switch, lateral LED-lighting 6000 K, 2x 6,3 W, 2x 660 lumen, EEC F</i> <b>brighthness dimmable</b></p>	100,0	68,2	2,8	<b>SPBSA10</b>		<b>1246</b>
 <p>LED-Aufbauleuchte für Spiegelpanel mit LED-Mini-Stecker, 6000 K, 13,7 W, 1440 Lumen, EEK F <b>Helligkeit dimmbar</b></p> <p><i>LED-lighting for mirror panel with LED-mini-plug, 6000 K, 13,7 W, 1440 lumen, EEC F</i> <b>brighthness dimmable</b></p>	100,0	2,4	10,0	<b>AWP100</b>		<b>415</b>

EEK/EEC=Energieeffizienzklasse/energy efficiency category  
Leuchtmittel sind nicht austauschbar / *illuminants are not interchangeable.*

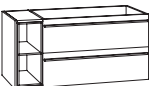
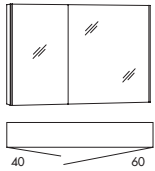

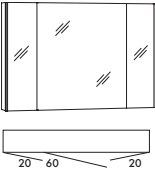

# 3250star »100 cm L Mineralmarmor/*marble minerals*«

Beschreibung Description	Maße in cm Dimensions in cm			Artikel-Nr. Article no.	Türanschlag	Identnummer ID number
	B/W	H	T/D			

	Mineralmarmor-Waschtisch <b>Ablage links</b> inkl. Überlauf  <i>marble minerals washbasin depot on the left incl. overflow</i>	100,5	2,0	45,0	<b>MWSTA10L</b> 		<b>1131</b>	
	Mineralmarmor-Waschtisch <b>Ablage links</b> , inkl. Überlauf <b>mit LED-Beleuchtung und Bewegungs- sensor</b> , 6000 K, 9,1 W, 706 Lumen, EEK G  <i>marble minerals washbasin depot on the left, incl. overflow with LED-lighting and motion sensor 6000 K, 9,1 W, 706 lumen, EEC G</i>	100,5	3,4	45,0	<b>MWSTA10L</b>   		<b>1591</b>	
						PG1	PG2	PG3
	Waschtisch-Unterschrank 2 Auszüge, <b>Ausschnitt Siphon rechts</b>  <i>washbasin base cabinet 2 extensions, cutout siphon right</i>	100,0	47,8	44,5	<b>WMKAA10SR</b>	<b>1476</b>	<b>1615</b>	<b>1730</b>
	Waschtisch-Unterschrank 2 Auszüge, <b>1 Einschubregal links</b>  <i>washbasin base cabinet 2 extensions, 1 push-in shelf left</i>	100,0	47,8	44,5	<b>WMKEAA10</b>	<b>1777</b>	<b>1892</b>	<b>2007</b>
	Spiegelschrank, 2 beidseitig verspiegelte Türen, 2 Glaseinlegeböden, inkl. Schalter/ Steckdose, seitliche LED-Beleuchtung, 6000 K, 2x 6,3 W, 2x 660 Lumen, EEK F  <i>mirror cabinet, 2 doors mirrored on both sides, 2 glass boards, incl. switch/socket lateral LED-lighting, 6000 K, 2x 6,3 W, 2x 660 lumen, EEC F</i>	100,0	68,2	13,6	<b>SAD10R</b> 			<b>1776</b>
	Spiegelschrank, 3 beidseitig verspiegelte Türen, 4 Glaseinlegeböden, inkl. Schalter/ Steckdose, seitliche LED-Beleuchtung, 6000 K, 2x 6,3 W, 2x 660 Lumen, EEK F  <i>mirror cabinet, 3 doors mirrored on both sides, 4 glass boards, incl. switch/socket lateral LED-lighting, 6000 K, 2x 6,3 W, 2x 660 lumen, EEC F</i>	100,0	68,2	13,6	<b>SAD10A</b> 			<b>2007</b>
	LED-Aufbauleuchte für Spiegelschrank mit LED-Mini-Stecker, ohne Schalter, 6000 K, 13,8 W, 1728 Lumen, EEK E  <i>LED-lighting for mirror cabinet with LED-mini-plug, without switch, 6000 K, 13,8 W, 1728 lumen, EEC E</i>	100,0	2,4	20,0	<b>AW100</b> 			<b>461</b>

EEK/EEC=Energieeffizienzklasse/energy efficiency category  
Leuchtmittel sind nicht austauschbar / illuminants are not interchangeable.

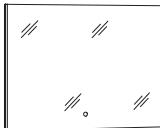





 Regalfarben unbedingt mit angeben, Übersicht siehe Seite 3. Please indicate shelf colours, overview see page 3.

Beschreibung <i>Description</i>	Maße in cm <i>Dimensions in cm</i>			Artikel-Nr. <i>Article no.</i>	Türanschlag <i>Door stop</i>	Identnummer <i>ID number</i>
	B/W	H	T/D			
 <p>Spiegelpaneel, Sensorschalter, seitliche LED-Beleuchtung 6000 K, 2x 6,3 W, 2x 660 Lumen, EEK F <b>Helligkeit dimmbar</b></p> <p><i>mirror panel, sensor switch, lateral LED-lighting 6000 K, 2x 6,3 W, 2x 660 lumen, EEC F</i> <b>brighthness dimmable</b></p>	100,0	68,2	2,8	<b>SPBSA10</b>		<b>1246</b>
 <p>LED-Aufbauleuchte für Spiegelpaneel mit LED-Mini-Stecker, 6000 K, 13,7 W, 1440 Lumen, EEK F <b>Helligkeit dimmbar</b></p> <p><i>LED-lighting for mirror panel with LED-mini-plug, 6000 K, 13,7 W, 1440 lumen, EEC F</i> <b>brighthness dimmable</b></p>	100,0	2,4	10,0	<b>AWP100</b>		<b>415</b>



EEK/EEC=Energieeffizienzklasse/energy efficiency category  
Leuchtmittel sind nicht austauschbar / *illuminants are not interchangeable.*



# 3250star »140 cm Mineralmarmor/marble minerals«

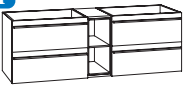

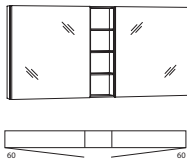
Beschreibung Description	Maße in cm Dimensions in cm			Artikel-Nr. Article no.	Türanschlag	Identnummer ID number
	B/W	H	T/D			



	Mineralmarmor-Doppelwaschtisch inkl. Überlauf <i>marble minerals double washbasin incl. overflow</i>	140,5	2,0	45,0	<b>MWSTA14D</b> 	<b>1453</b>
	Mineralmarmor-Doppelwaschtisch inkl. Überlauf <b>mit LED-Beleuchtung und Bewegungs- sensor, 6000 K, 13,0 W, 994 Lumen, EEK G</b> <i>marble minerals double washbasin incl. overflow with LED-lighting and motion sensor 6000 K, 13,0 W, 994 lumen, EEC G</i>	140,5	3,4	45,0	<b>MWSTAL14D</b>    Dieses Produkt enthält eine Lichtquelle der Energieeffizienzklasse G	<b>1961</b>

					PG1	PG2	PG3	
	Waschtisch-Unterschrank 4 Auszüge, <b>1 Einschubregal mittig</b> <i>washbasin base cabinet 4 extensions, 1 push-in shelf in center</i>	140,0	47,8	44,5	<b>WMKAEA14</b>	<b>2722</b>	<b>2929</b>	<b>3045</b>

	Spiegelschrank, 2 beidseitig verspiegelte Türen, 1 Regal mittig, 4 Glaseinlege- böden, inkl. Schalter/Steckdose, seitliche LED-Beleuchtung, 6000 K, 2x 6,3 W, 2x 660 Lumen, EEK F <i>mirror cabinet, 2 doors mirrored on both sides, 1 shelf in center, 4 glass boards, incl. switch/socket, lateral LED-lighting, 6000 K, 2x 6,3 W, 2x 660 lumen, EEC F</i>	140,0	68,2	13,6	<b>SADR14</b> 	<b>2860</b>
---	---	-------	------	------	---	-------------

	LED-Aufbauleuchte für Spiegelschrank mit LED-Mini-Stecker, ohne Schalter, 6000 K, 19,4 W, 2430 Lumen, EEK E <i>LED-lighting for mirror cabinet with LED-mini-plug, without switch, 6000 K, 19,4 W, 2430 lumen, EEC E</i>	140,0	2,4	20,0	<b>AW140</b> 	<b>530</b>
---	---	-------	-----	------	--	------------

	Spiegelpaneel, Sensorschalter, seitliche LED-Beleuchtung 6000 K, 2x 6,3 W, 2x 660 Lumen, EEK F <b>Helligkeit dimmbar</b> <i>mirror panel, sensor switch, lateral LED-lighting 6000 K, 2x 6,3 W, 2x 660 lumen, EEC F brightness dimmable</i>	140,0	68,2	2,8	<b>SPBSA14</b>  	<b>1384</b>
---	---	-------	------	-----	---	-------------

	LED-Aufbauleuchte für Spiegelpaneel mit LED-Mini-Stecker, 6000 K, 19,4 W, 2430 Lumen, EEK E <b>Helligkeit dimmbar</b> <i>LED-lighting for mirror panel with LED-mini-plug, 6000 K, 19,4 W, 2430 lumen, EEC E brightness dimmable</i>	140,0	2,4	10,0	<b>AWP140</b>  	<b>508</b>
---	--	-------	-----	------	--	------------

EEK/EEC=Energieeffizienzklasse/energy efficiency category

Leuchtmittel sind nicht austauschbar / illuminants are not interchangeable.

 Regalfarben unbedingt mit angeben, Übersicht siehe Seite 3. Please indicate shelf colours, overview see page 3.

# 3250star »Spiegelpaneele und Zubehör/mirror panels and accessoires«

Beschreibung Description	Maße in cm Dimensions in cm			Artikel-Nr. Article no.	Türanschlag Door stop	Identnummer ID number
	B/W	H	T/D			
 <p>Spiegelpaneel, Sensorschalter, satiniert, LED Beleuchtung, 4000 K, 17,3 W, 2415 Lumen, EEK G <b>Helligkeit dimmbar</b></p> <p><i>mirror panel, sensor switch, satined, LED-lighting, 4000 K, 17,3 W, 2415 lumen, EEC G</i> <b>brighness dimmable</b></p>	55,0	78,0	2,8	<b>SPE55</b>   Dieses Produkt enthält eine Lichtquelle der Energieeffizienzklasse G	1131	
 <p>Spiegelpaneel, Sensorschalter, satiniert, LED Beleuchtung, 4000 K, 13,5 W, 1890 Lumen, EEK G <b>Helligkeit dimmbar</b></p> <p><i>mirror panel, sensor switch, satined, LED-lighting, 4000 K, 13,5 W, 1890 lumen, EEC G</i> <b>brighness dimmable</b></p>	55,0	55,0	2,8	<b>SPK55</b>   Dieses Produkt enthält eine Lichtquelle der Energieeffizienzklasse G	992	
 <p>Spiegelpaneel, Sensorschalter, satiniert, LED Beleuchtung, 4000 K, 20,8 W, 2905 Lumen, EEK G <b>Helligkeit dimmbar</b></p> <p><i>mirror panel, sensor switch, satined, LED-lighting, 4000 K, 20,8 W, 2905 lumen, EEC G</i> <b>brighness dimmable</b></p>	78,0	78,0	2,8	<b>SPK78</b>   Dieses Produkt enthält eine Lichtquelle der Energieeffizienzklasse G	1292	
 <p>Schubkasteneinsatz (Kunststoff) für oberen Auszug vom WT-Unterschrank</p> <p><i>drawer insert part (plastic) for top drawer from base cabinet</i></p>	33,7	4,3	28,0	<b>SABEG3</b>	69	
 <p>Steckdose/Powerbox für Spiegelschränke Ausführung <b>Schweiz</b> IP44 mit USB-C Stecker</p> <p><i>Power socket for mirror cabinets Switzerland type IP44 with USB-C plug</i></p>				<b>Mehrpreis extra charge</b>	138	
 <p>Steckdose/Powerbox für Spiegelschränke Ausführung <b>Frankreich</b> mit USB-C Stecker</p> <p><i>Power socket for mirror cabinets France type with USB-C plug</i></p>				<b>Mehrpreis extra charge</b>	138	

EEK/EEC=Energieeffizienzklasse/energy efficiency category

Leuchtmittel sind nicht austauschbar / illuminants are not interchangeable.

**i** Weiteres Zubehör finden Sie im Register 3970 und Beistellschränke im Register 3990.  
 Further accessoires can be found in register 3970 and side cabinets in register 3990.



# 3260fair





# »3260fair«

## Piktogramme/pictograms



Keramik Waschtisch  
Ceramic washbasin



LED Lichtfarbe kalt  
LED colour temperature cold



LED mit Sensorschalter,  
Helligkeit dimmbar  
LED with sensor switch,  
brightness dimmable



LED Lichtfarbe warm  
LED colour temperature warm

## Keramik Waschtisch weiß alpin Glanz (PEK) Ceramic washbasin gloss alpine white (PEK)

≈ Beckenmaße in cm (BxHxT)  
basin dimensions in cm (WxHxD)

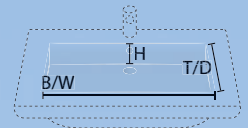

Detail



KWCHR8 | 51 x 13,5 x 32,5 cm



KWCHR10 | 51 x 13,5 x 32,5 cm



KWCHR12 | 51 x 13,5 x 32,5 cm



KWCHR12D | 42 x 11,5 x 32,5 cm

**!** Diese Keramikwaschtische benötigen keine Wandbefestigung.  
These ceramic basins do not require wall mounting.

# »3260fair«

## Keramik Waschtisch weiß alpin Glanz mit Dekorkante (PEK) Ceramic washbasin gloss alpine white with decor edge (PEK)

~ Beckenmaße in cm (BxHxD)  
basin dimensions in cm (WxHxD)

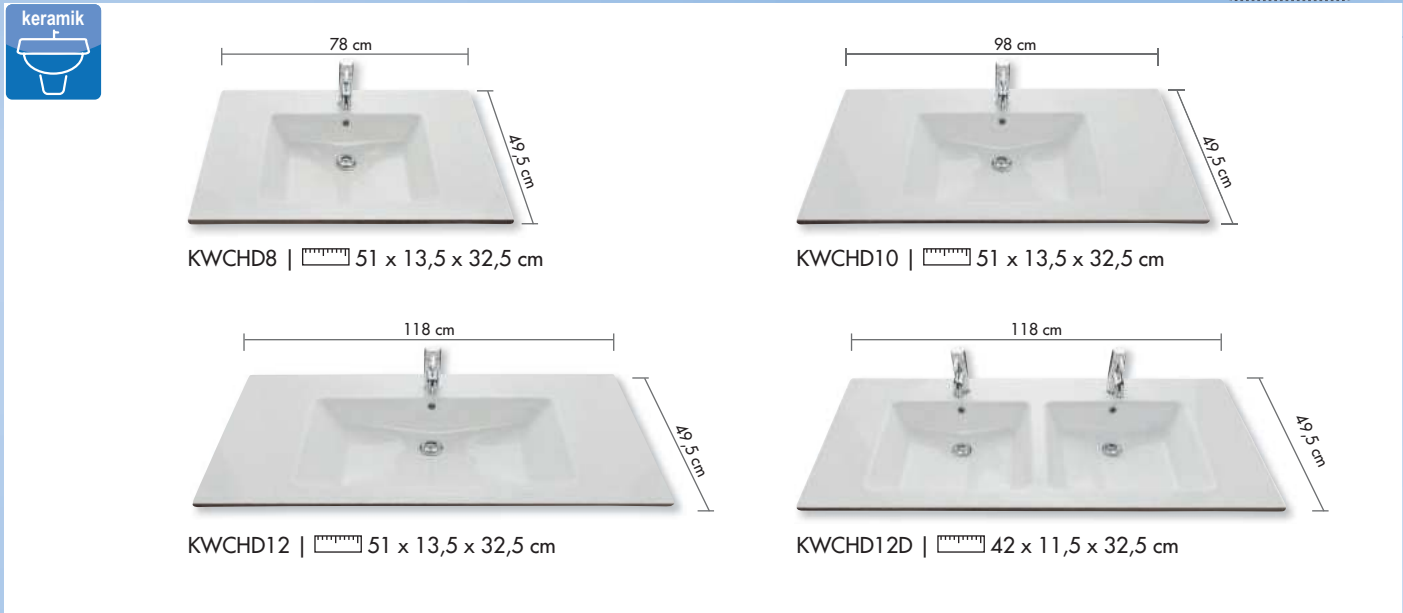
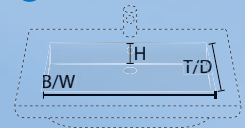

! Diese Keramikwaschtische benötigen keine Wandbefestigung.  
These ceramic basins do not require wall mounting.

### Dekorkanten-Farben/decor edge colours

<p>284</p>  <p><b>Anthrazit Seidenglanz</b> Silk Gloss Anthracite PE84</p>	<p>490</p>  <p><b>Kastanie Graphit Nachbildung</b> Graphite Chestnut Finish PE45</p>
<p>473</p>  <p><b>Eiche Struktur Natur Nachbildung</b> Oak Structure Nature Finish PE55</p>	<p>435</p>  <p><b>Eiche Struktur Weiß Nachbildung</b> <span style="background-color: #0070C0; color: white; padding: 2px;">NEW</span> Oak Structure White Finish PE40</p>
<p>426</p>  <p><b>Eiche Struktur Braun Nachbildung</b> <span style="background-color: #0070C0; color: white; padding: 2px;">NEW</span> Oak Structure Brown Finish PE70</p>	



Ohne Dekorkante/without decorative edge



Mit Dekorkante/with decorative edge



Mit Dekorkante/with decorative edge

#### Vorteil: PUR-Verklebung

Die Dekorkanten werden mit einem PUR-Kleber (Polyurethankleber) in einem industriellen Verfahren auf die Waschtische aufgebracht. Klebstoffe auf Polyurethan-Basis bieten vielfältige Einsatzmöglichkeiten und ein breites Spektrum an Eigenschaften für diese Anwendung:

- Dauerhaft mit hoher Scherfestigkeit
- Dauerhaft Wasserfest

#### Advantage: PUR bonding

The decorative edges are applied to the washbasins with a PUR glue (polyurethane adhesive) in an industrial process. Polyurethane based adhesives offer a variety of uses and a huge range of properties for this application:

- Permanently with high shear strength
- Permanently waterproof



## Schränke/cabinets 3260fair

### Frontfarben/front colours

#### Dickkante/thick edge

286



**Weiß Seidenglanz**  
Silk Gloss White  
PEE\_

284



**Anthrazit Seidenglanz**  
Silk Gloss Anthracite  
PEA\_

490



**Kastanie Graphit Nachbildung**  
Graphite Chestnut Finish  
PEC\_

473



**Eiche Struktur Natur Nachbildung**  
Oak Structure Nature Finish  
PEM\_

435



**Eiche Struktur Weiß Nachbildung** NEW  
Oak Structure White Finish  
PEL\_

426



**Eiche Struktur Braun Nachbildung** NEW  
Oak Structure Brown Finish  
PEH\_

#### MDF-foliert/MDF-coated

961



**Weiß Glanz**  
Gloss White  
PEG\_

438



**Anthrazit Glanz**  
Gloss Anthracite  
PEF\_

### Korpusfarben/basic shell colours

#### PG 1 Dickkante/thick edge

286



**Weiß Seidenglanz**  
Silk Gloss White  
E/PE86

284



**Anthrazit Seidenglanz**  
Silk Gloss Anthracite  
A/PE84

490



**Kastanie Graphit Nachbildung**  
Graphite Chestnut Finish  
C/PE45

473



**Eiche Struktur Natur Nachbildung**  
Oak Structure Nature Finish  
M/PE55

435



**Eiche Struktur Weiß Nachbildung** NEW  
Oak Structure White Finish  
L/PE40

426



**Eiche Struktur Braun Nachbildung** NEW  
Oak Structure Brown Finish  
H/PE70

#### PG 3 MDF-foliert/MDF-coated

042



**Weiß Glanz Folie**  
Gloss White  
G/PE50

438



**Anthrazit Glanz Folie**  
Gloss Anthracite  
F/PE30

#### ! BITTE BEACHTEN:

Die Front-/Korpuskombination „MDF-folierte FRONT (Variante: 961/438)“ mit „Korpus PG1 (Variante: 284/286/426/435/473/490)“ wird zu PG2 abgerechnet.

The front / basic shell combination „MDF-foiled front (variant: 961/438)“ with „basic shell PG1 (variant: 284/286/426/435/473/490)“ is billed to PG2.

## Regalfarben/shelf colours

287

**Weiß Seidenglanz**  
Silk Gloss White  
PE86

285

**Anthrazit Seidenglanz**  
Silk Gloss Anthracite  
PE84

491

**Kastanie Graphit Nachbildung**  
Graphite Chestnut Finish  
PE45

474

**Eiche Struktur Natur Nachbildung**  
Oak Structure Nature Finish  
PE55

436

**Eiche Struktur Weiß Nachbildung** **NEW**  
Oak Structure White Finish  
PE40

427

**Eiche Struktur Braun Nachbildung** **NEW**  
Oak Structure Brown Finish  
PE70

## Griffe/handles



**Edelstahl Optik**  
Stainless design

Griffnummer/handlenumber: 265/266/386/267/268/269/270  
⌀-⌀ 96 mm/128 mm/192 mm/256 mm/179-179 mm\*/179-179 mm\*/279-279 mm\*



**Schwarz Matt Struktur**  
Matt Black Structure

Griffnummer/handlenumber: 272/273/271/274/275/276/277  
⌀-⌀ 96 mm/128 mm/192 mm/256 mm/179-179 mm\*/179-179 mm\*/279-279 mm\*

⌀-⌀ = Bohrabstand/hole spacing \*drei Grifflochbohrungen

Die Angabe einer Griffnummer ist ausreichend. Die Griffe werden passend zur jeweiligen Schrankbreite beigelegt.  
The indication of one handle number is sufficient. The handles are supplied to match the respective cabinet width.

## Beleuchtung / lighting



**Aufbauleuchte LED**  
Top light LED

**Lichtfarbe Tageslicht (Kalt)**  
Luminous colour natural light (cold)



AW80, AWP80,  
AW100, AWP100  
AW120, AWP120











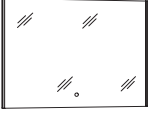
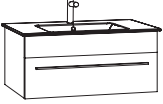

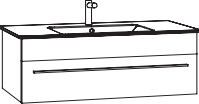

**Seitlich und oben LED Beleuchtung**  
lateral and top LED lighting



Die Steckdose / Powerbox für Spiegelschränke ist auch in Ausführung für die Schweiz / Frankreich erhältlich. Bitte Mehrpreis beachten (siehe Seite 17).  
The power socket for mirror cabinets is also available for Switzerland / France. Please note extra charge (see page 17).

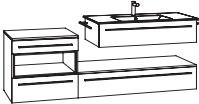



# 3260fair »Beispiel-Kombinationen/example-combinations«

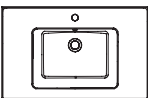

Beschreibung Description	Maße in cm Dimensions in cm			Artikel-Nr. Article no.	Türanschlag Door stop	Identnummer ID number		
	B/W	H	T/D			PG1	PG2	PG3
 <p>Kombination 80 cm bestehend aus: Spiegelpaneel, Sensorschalter Keramik-Waschtisch Waschtisch-Unterschrank, 1 feste Blende, 1 Auszug</p>  <p>combination 80 cm width consisting of: mirror panel, sensor switch ceramics washbasin washbasin base cabinet, 1 fixed cover, 1 extension</p>				<b>SPBSA8</b> <b>KWCHR8</b> <b>WKHBS7</b>	    	1154 877 830 <hr/> 2861	1154 877 992 <hr/> 3023	1154 877 1246 <hr/> 3277
 <p>Kombination 100 cm bestehend aus: Spiegelschrank, seitliche LED-Beleuchtung Keramik-Waschtisch Waschtisch-Unterschrank, 1 feste Blende, 1 Auszug 1 Tür links</p>  <p>combination 100 cm width consisting of: mirror cabinet, lateral LED-lighting ceramics washbasin washbasin base cabinet, 1 fixed cover, 1 extension</p>				<b>SADA10</b> <b>KWCHR10</b> <b>WKHBS9</b>	  	2076 1038 900 <hr/> 4014	2076 1038 1107 <hr/> 4221	2076 1038 1384 <hr/> 4498
 <p>Kombination 140 cm bestehend aus: Spiegelschrank, seitliche LED-Beleuchtung Regal neben dem Spiegelschrank Keramik-Waschtisch Waschtisch-Unterschrank, 1 Schubkasten, 1 Auszug Unterschrank, 2 Auszüge</p>  <p>combination 140 cm width consisting of: mirror cabinet, lateral LED-lighting shelf besides mirror cabinet ceramics washbasin, depot right washbasin base cabinet, 1 drawer, 1 extension base cabinet, 2 extensions</p>				<b>SADA8R</b> <b>SRB6</b> <b>KWCHR8</b> <b>WKHBSA7</b> <b>UHAA6F</b>	  	1707 295 877 1338 1176 <hr/> 5393	1707 295 877 1638 1362 <hr/> 5879	1707 295 877 2030 1822 <hr/> 6731
 <p>Kombination 180 cm bestehend aus: Spiegelschrank, seitliche LED-Beleuchtung Regal neben dem Spiegelschrank Keramik-Waschtisch Waschtisch-Unterschrank, 1 Schubkasten Unterschrank, 1 Auszug Designsiphon Unterschrank, 1 Schubkasten, 1 Einschubregal, 1 Auszug Oberschrank, 2 Türen</p>  <p>combination 180 cm width consisting of: mirror cabinet, lateral LED-lighting side shelf adjacent to mirror cabinet ceramics washbasin washbasin base cabinet, 1 drawer design siphon base cabinet, 1 extension base cabinet, 1 drawer, 1 push-in shelf, 1 extension top cabinet, 2 doors</p>				<b>SADA10</b> <b>REB20</b> <b>KWCHR10</b> <b>WKHS9</b> <b>UHA11F</b> <b>DS</b> <b>UHSEA6F</b> <b>OT60D</b>	  	2076 378 1038 808 1038 236 1384 715 <hr/> 7673	2076 378 1038 946 1315 236 1615 923 <hr/> 8527	2076 378 1038 1176 1753 236 2168 1016 <hr/> 9841

Handtuchhalter, Regale, Unterbaubeleuchtungen und weiteres Zubehör finden Sie in der Rubrik 3970zubehör.  
Towel rails, shelves, base lightings and other accessories can be found in the 3970accessories range.

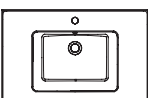
# 3260fair »80 cm Keramik/ceramic«

Beschreibung Description	Maße in cm Dimensions in cm			Artikel-Nr. Article no.	Türanschlag Door stop	Identnummer ID number
	B/W	H	T/D			

	Keramik-Waschtisch inkl. Überlauf  <i>ceramic washbasin incl. overflow</i>	81,0	1,5	51,0	<b>KWCHR8</b> 	<b>877</b>
	Keramik-Waschtisch <b>mit Dekorkante</b> inkl. Überlauf  <i>ceramic washbasin <b>with decor edge</b> incl. overflow</i>	78,0	1,5	49,5	<b>KWCHD8</b> 	<b>1569</b>

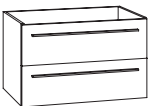
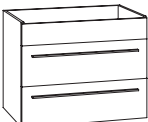
						PG1	PG2	PG3
	Waschtisch-Unterschrank 1 Schubkasten  <i>washbasin base cabinet 1 drawer</i>	77,0	23,8	49,3	<b>WKHS7</b>	<b>761</b>	<b>900</b>	<b>1154</b>
	Waschtisch-Unterschrank 1 feste Blende, 1 Schubkasten  <i>washbasin base cabinet 1 fixed cover, 1 drawer</i>	77,0	36,6	49,3	<b>WKHBS7</b>	<b>830</b>	<b>992</b>	<b>1246</b>
	Waschtisch-Unterschrank 1 Schubkasten, 1 Auszug  <i>washbasin base cabinet 1 drawer, 1 extension</i>	77,0	47,8	49,3	<b>WKHSA7</b>	<b>1200</b>	<b>1453</b>	<b>1799</b>
	Waschtisch-Unterschrank 1 feste Blende, 1 Schubkasten, 1 Auszug  <i>washbasin base cabinet 1 fixed cover, 1 drawer, 1 extension</i>	77,0	60,6	49,3	<b>WKHBSA7</b>	<b>1338</b>	<b>1638</b>	<b>2030</b>

	Spiegelschrank, 2 beidseitig verspiegelte Türen, 2 Glaseinlegeböden, inkl. Schalter/ Steckdose, seitliche LED-Beleuchtung, 6000 K, 2x 6,3 W, 2x 660 Lumen, EEK F  <i>mirror cabinet, 2 doors mirrored on both sides, 2 glass boards, incl. switch/socket lateral LED-lighting, 6000 K, 2x 6,3 W, 2x 660 lumen, EEC F</i>	80,0	68,2	17,6	<b>SADA8L</b>   Dieses Produkt enthält eine Lichtquelle der Energieeffizienzklasse F	<b>1707</b>
	Spiegelschrank, 2 beidseitig verspiegelte Türen, 2 Glaseinlegeböden, inkl. Schalter/ Steckdose, seitliche LED-Beleuchtung, 6000 K, 2x 6,3 W, 2x 660 Lumen, EEK F  <i>mirror cabinet, 2 doors mirrored on both sides, 2 glass boards, incl. switch/socket lateral LED-lighting, 6000 K, 2x 6,3 W, 2x 660 lumen, EEC F</i>	80,0	68,2	17,6	<b>SADA8R</b>   Dieses Produkt enthält eine Lichtquelle der Energieeffizienzklasse F	<b>1707</b>
	LED-Aufbauleuchte für Spiegelschrank mit LED-Mini-Stecker, 6000 K, 10,8 W, 1350 Lumen, EEK E  <i>LED-lighting for mirror cabinet with LED-mini-plug, 6000 K, 10,8 W, 1350 lumen, EEC E</i>	80,0	2,4	20,0	<b>AW80</b>   Dieses Produkt enthält eine Lichtquelle der Energieeffizienzklasse E	<b>415</b>

EEK/EEC=Energieeffizienzklasse/energy efficiency category

Leuchtmittel sind nicht austauschbar / illuminants are not interchangeable.

 Dekorkantenfarben unbedingt mit angeben, Übersicht siehe Seite 2. Please indicate decor edge colours, overview see page 2.

# 3260fair »80 cm Keramik/ceramic«





Beschreibung Description	Maße in cm Dimensions in cm			Artikel-Nr. Article no.	Türanschlag Door stop	Identnummer ID number
	B/W	H	T/D			



	<p>Spiegelschrank, 3 Spiegeltüren - davon 2 trapezförmig angeordnet, 6 Glaseinlegeböden, inkl. Schalter/Steckdose, <b>seitlich und oben LED-Beleuchtung</b>, 6000 K, 17,2 W, 960 Lumen, EEK E</p>	80,0	68,2	17,6	<b>SDU8</b>		<b>2238</b>	
	<p><i>mirror cabinet, 3 mirror doors - 2 of them are arranged in a trapeze, 6 glass shelves, incl. switch/socket, <b>lateral and top LED lighting</b>, 6000 K, 17,2 W, 960 lumen, EEC E</i></p>					<p>Dieses Produkt enthält eine Lichtquelle der Energieeffizienzklasse E</p>		
	<p>Spiegelpaneel, Sensorschalter, seitliche LED-Beleuchtung 6000 K, 2x 6,3 W, <b>Helligkeit dimmbar</b></p>	80,0	68,2	2,8	<b>SPBSA8</b>			<b>1154</b>
	<p><i>mirror panel, sensor switch, lateral LED-lighting 6000 K, 2x 6,3 W, 2x 660 lumen, EEC F <b>brighness dimmable</b></i></p>					<p>Dieses Produkt enthält eine Lichtquelle der Energieeffizienzklasse F</p>		
	<p>LED-Aufbauleuchte für Spiegelpaneel mit LED-Mini-Stecker, 6000 K, 10,8 W, 1350 Lumen, EEK E <b>Helligkeit dimmbar</b></p>	80,0	2,4	10,0	<b>AWP80</b>			<b>370</b>
	<p><i>LED-lighting for mirror panel with LED-mini-plug, 6000 K, 10,8 W, 1350 lumen, EEC E <b>brighness dimmable</b></i></p>					<p>Dieses Produkt enthält eine Lichtquelle der Energieeffizienzklasse E</p>		

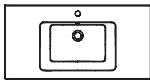

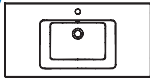

EEK/EEC=Energieeffizienzklasse/energy efficiency category  
Leuchtmittel sind nicht austauschbar / illuminants are not interchangeable.

# 3260fair »100 cm Keramik/ceramic«

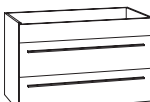
Beschreibung Description	Maße in cm Dimensions in cm			Artikel-Nr. Article no.	Türanschlag Door stop	Identnummer ID number
	B/W	H	T/D			

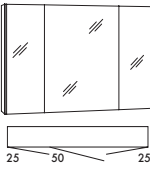
	Keramik-Waschtisch inkl. Überlauf  <i>ceramic washbasin incl. overflow</i>	101,0	1,5	51,0	<b>KWCHR10</b> 		<b>1038</b>
	Keramik-Waschtisch <b>mit Dekorkante</b> inkl. Überlauf  <i>ceramic washbasin <b>with decor edge</b> incl. overflow</i>	98,0	1,5	49,5	<b>KWCHD10</b> 		<b>1753</b>

						PG1	PG2	PG3
	Waschtisch-Unterschrank 1 Schubkasten  <i>washbasin base cabinet 1 drawer</i>	97,0	23,8	49,3	<b>WKHS9</b>	<b>808</b>	<b>946</b>	<b>1176</b>
	Waschtisch-Unterschrank 1 feste Blende, 1 Schubkasten  <i>washbasin base cabinet 1 fixed cover, 1 drawer</i>	97,0	36,6	49,3	<b>WKHBS9</b>	<b>900</b>	<b>1107</b>	<b>1384</b>
	Waschtisch-Unterschrank 1 Schubkasten, 1 Auszug  <i>washbasin base cabinet 1 drawer, 1 extension</i>	97,0	47,8	49,3	<b>WKHSA9</b>	<b>1315</b>	<b>1615</b>	<b>1937</b>
	Waschtisch-Unterschrank 1 feste Blende, 1 Schubkasten, 1 Auszug  <i>washbasin base cabinet 1 fixed cover, 1 drawer, 1 extension</i>	97,0	60,6	49,3	<b>WKHBSA9</b>	<b>1453</b>	<b>1822</b>	<b>2261</b>







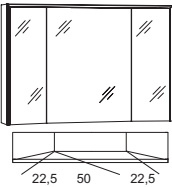

	Spiegelschrank, 3 beidseitig verspiegelte Türen, 4 Glaseinlegeböden, inkl. Schalter/ Steckdose, seitliche LED-Beleuchtung, 6000 K, 2x 6,3 W, 2x 660 Lumen, EEK F  <i>mirror cabinet, 3 doors mirrored on both sides, 4 glass boards, incl. switch/socket lateral LED-lighting, 6000 K, 2x 6,3 W, 2x 660 lumen, EEC F</i>	100,0	68,2	17,6	<b>SADA10</b> 		<b>2076</b>
	LED-Aufbauleuchte für Spiegelschrank mit LED-Mini-Stecker, 6000 K, 13,8 W, 1728 Lumen, EEK E  <i>LED-lighting for mirror cabinet with LED-mini-plug, 6000 K, 13,8 W, 1728 lumen, EEC E</i>	100,0	2,4	20,0	<b>AW100</b> 		<b>461</b>

EEK/EEC=Energieeffizienzklasse/energy efficiency category

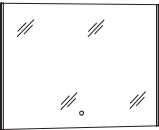
Leuchtmittel sind nicht austauschbar / illuminants are not interchangeable.

 Dekorkantenfarben unbedingt mit angeben, Übersicht siehe Seite 2. Please indicate decor edge colours, overview see page 2.





# 3260fair »100 cm Keramik/ceramic«



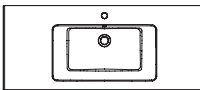

Beschreibung Description	Maße in cm Dimensions in cm			Artikel-Nr. Article no.	Türanschlag Door stop	Identnummer ID number
	B/W	H	T/D			
 <p>Spiegelschrank, 3 Spiegeltüren - davon 2 trapezförmig angeordnet, 6 Glaseinlegeböden, inkl. Schalter/Steckdose, <b>seitlich und oben LED-Beleuchtung</b>, 6000 K, 18,7 W, 960 Lumen, EEK E</p> <p><i>mirror cabinet, 3 mirror doors - 2 of them are arranged in a trapeze, 6 glass shelves, incl. switch/socket, <b>lateral and top LED lighting</b>, 6000 K, 18,7 W, 960 lumen, EEC E</i></p>	100,0	68,2	17,6	<b>SDU10</b>		<b>2376</b>
Dieses Produkt enthält eine Lichtquelle der Energieeffizienzklasse E						
 <p>Spiegelpaneel, Sensorschalter, seitliche LED-Beleuchtung 6000 K, 2x 6,3 W, <b>Helligkeit dimmbar</b></p> <p><i>mirror panel, sensor switch, lateral LED-lighting 6000 K, 2x 6,3 W, 2x 660 lumen, EEC F <b>brighness dimmable</b></i></p>	100,0	68,2	2,8	<b>SPBSA10</b>	 	<b>1246</b>
Dieses Produkt enthält eine Lichtquelle der Energieeffizienzklasse F						
 <p>LED-Aufbauleuchte für Spiegelpaneel mit LED-Mini-Stecker, 6000 K, 13,7 W, 1440 Lumen, EEK F <b>Helligkeit dimmbar</b></p> <p><i>LED-lighting for mirror panel with LED-mini-plug, 6000 K, 13,7 W, 1440 lumen, EEC F <b>brighness dimmable</b></i></p>	100,0	2,4	10,0	<b>AWP100</b>	 	<b>415</b>
Dieses Produkt enthält eine Lichtquelle der Energieeffizienzklasse F						

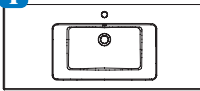



EEK/EEC=Energieeffizienzklasse/energy efficiency category  
Leuchtmittel sind nicht austauschbar / illuminants are not interchangeable.

# 3260fair »120 cm Keramik/ceramic«

Beschreibung Description	Maße in cm Dimensions in cm			Artikel-Nr. Article no.	Türanschlag Door stop	Identnummer ID number
	B/W	H	T/D			

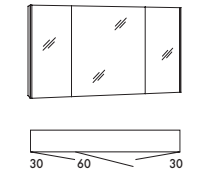
	Keramik-Waschtisch inkl. Überlauf  <i>ceramic washbasin incl. overflow</i>	121,0	1,5	51,0	<b>KWCHR12</b> 	<b>2053</b>
	Keramik-Waschtisch <b>mit Dekorkante</b> inkl. Überlauf  <i>ceramic washbasin <b>with decor edge</b> incl. overflow</i>	118,0	1,5	49,5	<b>KWCHD12</b> 	<b>2976</b>

						PG1	PG2	PG3
	Waschtisch-Unterschrank 1 Schubkasten  <i>washbasin base cabinet 1 drawer</i>	117,0	23,8	49,3	<b>WKHS11</b>	<b>923</b>	<b>1107</b>	<b>1384</b>
	Waschtisch-Unterschrank 1 feste Blende, 1 Schubkasten  <i>washbasin base cabinet 1 fixed cover, 1 drawer</i>	117,0	36,6	49,3	<b>WKHSB11</b>	<b>1038</b>	<b>1269</b>	<b>1569</b>
	Waschtisch-Unterschrank 1 Schubkasten, 1 Auszug  <i>washbasin base cabinet 1 drawer, 1 extension</i>	117,0	47,8	49,3	<b>WKHSA11</b>	<b>1500</b>	<b>1846</b>	<b>2215</b>
	Waschtisch-Unterschrank 1 feste Blende, 1 Schubkasten, 1 Auszug  <i>washbasin base cabinet 1 fixed cover, 1 drawer, 1 extension</i>	117,0	60,6	49,3	<b>WKHBSA11</b>	<b>1661</b>	<b>2076</b>	<b>2561</b>

	Spiegelschrank, 3 beidseitig verspiegelte Türen, 6 Glaseinlegeböden, inkl. Schalter/ Steckdose, seitliche LED-Beleuchtung, 6000 K, 2x 6,3 W, 2x 660 Lumen, EEK F  <i>mirror cabinet, 3 doors mirrored on both sides, 6 glass boards, incl. switch/socket lateral LED-lighting, 6000 K, 2x 6,3 W, 2x 660 lumen, EEC F</i>	120,0	68,2	17,6	<b>SADA12</b> 	<b>2168</b>
	LED-Aufbauleuchte für Spiegelschrank mit LED-Mini-Stecker, 6000 K, 16,8 W, 2106 Lumen, EEK E  <i>LED-lighting for mirror cabinet with LED-mini-plug, 6000 K, 16,8 W, 2106 lumen, EEC E</i>	120,0	2,4	20,0	<b>AW120</b> 	<b>485</b>







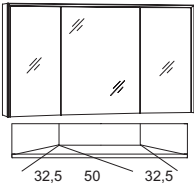

EEK/EEC=Energieeffizienzklasse/energy efficiency category

Leuchtmittel sind nicht austauschbar / illuminants are not interchangeable.

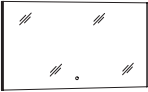
 Dekorkantenfarben unbedingt mit angeben, Übersicht siehe Seite 2. Please indicate decor edge colours, overview see page 2.



# 3260fair »120 cm Keramik/ceramic«





Beschreibung Description	Maße in cm Dimensions in cm			Artikel-Nr. Article no.	Türanschlag Door stop	Identnummer ID number
	B/W	H	T/D			
 <p>Spiegelschrank, 3 Spiegeltüren - davon 2 trapezförmig angeordnet, 6 Glaseinlegeböden, inkl. Schalter/Steckdose, <b>seitlich und oben LED-Beleuchtung</b>, 6000 K, 20,3 W, 960 Lumen, EEK E</p> <p><i>mirror cabinet, 3 mirror doors - 2 of them are arranged in a trapeze, 6 glass shelves, incl. switch/socket, <b>lateral and top LED lighting</b>, 6000 K, 20,3 W, 960 lumen, EEC E</i></p>	120,0	68,2	17,6	<b>SDU12</b>		<b>2492</b>
Dieses Produkt enthält eine Lichtquelle der Energieeffizienzklasse E						
 <p>Spiegelpaneel, Sensorschalter, seitliche LED-Beleuchtung 6000 K, 2x 6,3 W, <b>Helligkeit dimmbar</b></p> <p><i>mirror panel, sensor switch, lateral LED-lighting 6000 K, 2x 6,3 W, <b>brighness dimmable</b></i></p>	120,0	68,2	2,8	<b>SPBSA12</b>	 	<b>1292</b>
Dieses Produkt enthält eine Lichtquelle der Energieeffizienzklasse F						
 <p>LED-Aufbauleuchte für Spiegelpaneel mit LED-Mini-Stecker, 6000 K, 17,3 W, 2160 Lumen, EEK E <b>Helligkeit dimmbar</b></p> <p><i>LED-lighting for mirror panel with LED-mini-plug, 6000 K, 17,3 W, 2160 lumen, EEC E <b>brighness dimmable</b></i></p>	120,0	2,4	10,0	<b>AWP120</b>	 	<b>439</b>
Dieses Produkt enthält eine Lichtquelle der Energieeffizienzklasse E						



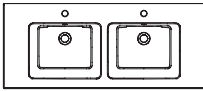

EEK/EEC=Energieeffizienzklasse/energy efficiency category

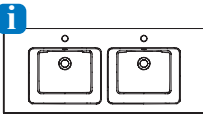



Leuchtmittel sind nicht austauschbar / illuminants are not interchangeable.

# 3260fair »120 cm D Keramik/ceramic«

Beschreibung Description	Maße in cm Dimensions in cm			Artikel-Nr. Article no.	Türanschlag Door stop	Identnummer ID number
	B/W	H	T/D			

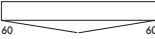
	Keramik-Doppel-Waschtisch inkl. Überlauf  <i>ceramic double washbasin incl. overflow</i>	121,0	1,5	51,0	<b>KWCHR12D</b> 	<b>2053</b>
	Keramik-Doppel-Waschtisch <b>mit Dekor- kante</b> , inkl. Überlauf  <i>ceramic double washbasin <b>with decor edge</b>, incl. overflow</i>	118,0	1,5	49,5	<b>KWCHD12D</b> 	<b>2976</b>

						PG1	PG2	PG3
	Waschtisch-Unterschrank für Doppelwaschtisch 1 Schubkasten  <i>washbasin base cabinet for double washbasin 1 drawer</i>	117,0	23,8	49,3	<b>WKHS11D</b>	<b>1085</b>	<b>1292</b>	<b>1569</b>
	Waschtisch-Unterschrank für Doppelwaschtisch 1 feste Blende, 1 Schubkasten  <i>washbasin base cabinet for double washbasin 1 fixed cover, 1 drawer</i>	117,0	36,6	49,3	<b>WKHBS11D</b>	<b>1176</b>	<b>1431</b>	<b>1753</b>
	Waschtisch-Unterschrank für Doppelwaschtisch 1 Schubkasten, 1 Auszug  <i>washbasin base cabinet for double washbasin 1 drawer, 1 extension</i>	117,0	47,8	49,3	<b>WKHSA11D</b>	<b>1546</b>	<b>1892</b>	<b>2307</b>
	Waschtisch-Unterschrank für Doppelwaschtisch 1 feste Blende, 1 Schubkasten, 1 Auszug  <i>washbasin base cabinet for double washbasin 1 fixed cover, 1 drawer, 1 extension</i>	117,0	60,6	49,3	<b>WKHBSA11D</b>	<b>1707</b>	<b>2123</b>	<b>2607</b>

 	Spiegelschrank, 2 beidseitig verspiegelte Türen, 4 Glaseinlegeböden, inkl. Schalter/ Steckdose, seitliche LED-Beleuchtung, 6000 K, 2x 6,3 W, 2x 660 Lumen, EEK F  <i>mirror cabinet, 2 doors mirrored on both sides, 4 glass boards, incl. switch/socket lateral LED-lighting, 6000 K, 2x 6,3 W, 2x 660 lumen, EEC F</i>	120,0	68,2	17,6	<b>SADA12D</b> 	<b>1961</b>
	LED-Aufbauleuchte für Spiegelschrank mit LED-Mini-Stecker, 6000 K, 16,8 W, 2106 Lumen, EEK E  <i>LED-lighting for mirror cabinet with LED-mini-plug, 6000 K, 16,8 W, 2106 lumen, EEC E</i>	120,0	2,4	20,0	<b>AW120</b> 	<b>485</b>







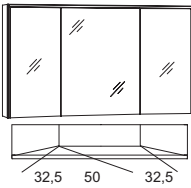

EEK/EEC=Energieeffizienzklasse/energy efficiency category

Leuchtmittel sind nicht austauschbar / illuminants are not interchangeable.

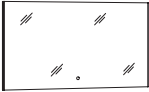
 Dekorkantenfarben unbedingt mit angeben, Übersicht siehe Seite 2. Please indicate decor edge colours, overview see page 2.

# 3260fair »120 cm D Keramik/ceramic«











Beschreibung Description	Maße in cm Dimensions in cm			Artikel-Nr. Article no.	Türanschlag Door stop	Identnummer ID number
	B/W	H	T/D			

	<p>Spiegelschrank, 3 Spiegeltüren - davon 2 trapezförmig angeordnet, 6 Glaseinlegeböden, inkl. Schalter/Steckdose, <b>seitlich und oben LED-Beleuchtung</b>, 6000 K, 20,3 W, 960 Lumen, EEK E</p> <p><i>mirror cabinet, 3 mirror doors - 2 of them are arranged in a trapeze, 6 glass shelves, incl. switch/socket, <b>lateral and top LED lighting</b>, 6000 K, 20,3 W, 960 lumen, EEC E</i></p>	120,0	68,2	17,6	<p><b>SDU12</b></p>  <p>Dieses Produkt enthält eine Lichtquelle der Energieeffizienzklasse E</p>	2492
	<p>Spiegelpaneel, Sensorschalter, seitliche LED-Beleuchtung 6000 K, 2x 6,3 W, <b>Helligkeit dimmbar</b></p> <p><i>mirror panel, sensor switch, lateral LED-lighting 6000 K, 2x 6,3 W, <b>brighness dimmable</b></i></p>	120,0	68,2	2,8	<p><b>SPBSA12</b></p>   <p>Dieses Produkt enthält eine Lichtquelle der Energieeffizienzklasse F</p>	1292
	<p>LED-Aufbauleuchte für Spiegelpaneel mit LED-Mini-Stecker, 6000 K, 17,3 W, 2160 Lumen, EEK E <b>Helligkeit dimmbar</b></p> <p><i>LED-lighting for mirror panel with LED-mini-plug, 6000 K, 17,3 W, 2160 lumen, EEC E <b>brighness dimmable</b></i></p>	120,0	2,4	10,0	<p><b>AWP120</b></p>   <p>Dieses Produkt enthält eine Lichtquelle der Energieeffizienzklasse E</p>	439

EEK/EEC=Energieeffizienzklasse/energy efficiency category

Leuchtmittel sind nicht austauschbar / illuminants are not interchangeable.



# 3260fair »Unterschränke mit Abdeckplatte/base cabinets with cover plaid«

Beschreibung Description	Maße in cm Dimensions in cm			Artikel-Nr. Article no.	Türanschlag Door stop	Identnummer ID number		
	B/W	H	T/D			PG1	PG2	PG3
 Unterschränk inkl. Abdeckplatte 1 Auszug <i>base cabinet incl. top 1 extension</i>	40,0	25,6	49,3	<b>UHA4F</b>		<b>715</b>	<b>830</b>	<b>1107</b>
 Unterschränk inkl. Abdeckplatte 1 Schubkasten, 1 Auszug <i>base cabinet incl. top 1 drawer, 1 extension</i>	40,0	38,4	49,3	<b>UHSA4F</b>		<b>969</b>	<b>1176</b>	<b>1546</b>
 Unterschränk inkl. Abdeckplatte 2 Auszüge <i>base cabinet incl. top 2 extensions</i>	40,0	49,6	49,3	<b>UHAA4F</b>		<b>1016</b>	<b>1315</b>	<b>1707</b>
 Unterschränk inkl. Abdeckplatte 1 Schubkasten, 2 Auszüge <i>sideboard incl. top 1 drawer, 2 extensions</i>	40,0	62,4	49,3	<b>UHSA4F</b>		<b>1338</b>	<b>1569</b>	<b>2145</b>
  Unterschränk inkl. Abdeckplatte 1 Schubkasten, 1 Einschubregal, 1 Auszug <i>sideboard incl. top 1 drawer, 1 push-in shelf, 1 extension</i>	40,0	62,4	49,3	<b>UHSEA4F</b>		<b>1223</b>	<b>1453</b>	<b>1868</b>
 Unterschränk inkl. Abdeckplatte 1 Auszug <i>base cabinet incl. top 1 extension</i>	60,0	25,6	49,3	<b>UHA6F</b>		<b>761</b>	<b>900</b>	<b>1200</b>
 Unterschränk inkl. Abdeckplatte 1 Schubkasten, 1 Auszug <i>base cabinet incl. top 1 drawer, 1 extension</i>	60,0	38,4	49,3	<b>UHSA6F</b>		<b>1131</b>	<b>1315</b>	<b>1707</b>
 Unterschränk inkl. Abdeckplatte 2 Auszüge <i>base cabinet incl. top 2 extensions</i>	60,0	49,6	49,3	<b>UHAA6F</b>		<b>1176</b>	<b>1362</b>	<b>1822</b>
 Unterschränk inkl. Abdeckplatte 1 Schubkasten, 2 Auszüge <i>sideboard incl. top 1 drawer, 2 extensions</i>	60,0	62,4	49,3	<b>UHSA6F</b>		<b>1453</b>	<b>1753</b>	<b>2215</b>
  Unterschränk inkl. Abdeckplatte 1 Schubkasten, 1 Einschubregal, 1 Auszug <i>sideboard incl. top 1 drawer, 1 push-in shelf, 1 extension</i>	60,0	62,4	49,3	<b>UHSEA6F</b>		<b>1384</b>	<b>1615</b>	<b>2168</b>







 Regalfarben unbedingt mit angeben, Übersicht siehe Seite 4. Please indicate shelf colours, overview see page 4.

# 3260fair »Unterschränke mit Abdeckplatte/base cabinets with cover plaid«

Beschreibung Description	Maße in cm Dimensions in cm			Artikel-Nr. Article no.	Türanschlag Door stop	Identnummer ID number		
	B/W	H	T/D			PG1	PG2	PG3

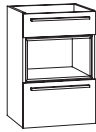
						PG1	PG2	PG3
	Unterschrank inkl. Abdeckplatte 1 Auszug  <i>base cabinet incl. top 1 extension</i>	97,0	25,6	49,3	<b>UHA9F</b>	<b>992</b>	<b>1176</b>	<b>1569</b>
	Unterschrank inkl. Abdeckplatte 1 Schubkasten, 1 Auszug  <i>base cabinet incl. top 1 drawer, 1 extension</i>	97,0	38,4	49,3	<b>UHSA9F</b>	<b>1431</b>	<b>1799</b>	<b>2215</b>
	Unterschrank inkl. Abdeckplatte 2 Auszüge  <i>base cabinet incl. top 2 extensions</i>	97,0	49,6	49,3	<b>UHAA9F</b>	<b>1476</b>	<b>1846</b>	<b>2284</b>
	Unterschrank inkl. Abdeckplatte 1 Schubkasten, 2 Auszüge  <i>sideboard incl. top 1 drawer, 2 extensions</i>	97,0	62,4	49,3	<b>UHSAA9F</b>	<b>1846</b>	<b>2307</b>	<b>2769</b>
	Unterschrank inkl. Abdeckplatte 1 Auszug  <i>base cabinet incl. top 1 extension</i>	117,0	25,6	49,3	<b>UHA11F</b>	<b>1038</b>	<b>1315</b>	<b>1753</b>
	Unterschrank inkl. Abdeckplatte 1 Schubkasten, 1 Auszug  <i>base cabinet incl. top 1 drawer, 1 extension</i>	117,0	38,4	49,3	<b>UHSA11F</b>	<b>1569</b>	<b>1961</b>	<b>2423</b>
	Unterschrank inkl. Abdeckplatte 2 Auszüge  <i>base cabinet incl. top 2 extensions</i>	117,0	49,6	49,3	<b>UHAA11F</b>	<b>1615</b>	<b>1984</b>	<b>2538</b>
	Unterschrank inkl. Abdeckplatte 1 Schubkasten, 2 Auszüge  <i>sideboard incl. top 1 drawer, 2 extensions</i>	117,0	62,4	49,3	<b>UHSAA11F</b>	<b>2053</b>	<b>2653</b>	<b>3299</b>



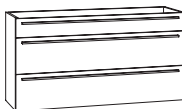



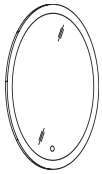

Beschreibung Description	Maße in cm Dimensions in cm			Artikel-Nr. Article no.	Türanschlag Door stop	Identnummer ID number		
	B/W	H	T/D					

Ohne Abdeckplatte / without top						PG1	PG2	PG3	
	Unterschränk ohne Abdeckplatte 1 Schubkasten, 2 Auszüge  <i>base cabinet without top 1 drawer, 2 extensions</i>	40,0	60,6	35,0	<b>UHSAA4</b>	<b>1131</b>	<b>1384</b>	<b>1892</b>	
		Unterschränk ohne Abdeckplatte 1 Schubkasten, 1 Einschubregal, 1 Auszug  <i>base cabinet without top 1 drawer, 1 push-in shelf, 1 extension</i>	40,0	60,6	35,0	<b>UHSEA4</b>	<b>1085</b>	<b>1338</b>	<b>1868</b>
	Unterschränk ohne Abdeckplatte 1 Schubkasten, 2 Auszüge  <i>base cabinet without top 1 drawer, 2 extensions</i>	60,0	60,6	35,0	<b>UHSAA6</b>	<b>1269</b>	<b>1546</b>	<b>1961</b>	
		Unterschränk ohne Abdeckplatte 1 Schubkasten, 1 Einschubregal, 1 Auszug  <i>base cabinet without top 1 drawer, 1 push-in shelf, 1 extension</i>	60,0	60,6	35,0	<b>UHSEA6</b>	<b>1223</b>	<b>1500</b>	<b>1915</b>
	Unterschränk ohne Abdeckplatte 1 Schubkasten, 2 Auszüge  <i>base cabinet without top 1 drawer, 2 extensions</i>	97,0	60,6	35,0	<b>UHSAA9</b>	<b>1569</b>	<b>2007</b>	<b>2538</b>	
	Unterschränk ohne Abdeckplatte 1 Schubkasten, 2 Auszüge  <i>base cabinet without top 1 drawer, 2 extensions</i>	117,0	60,6	35,0	<b>UHSAA11</b>	<b>1707</b>	<b>2238</b>	<b>2838</b>	

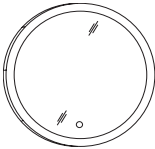
						PG1 Dickkante/thick edge
	Maßvariable Abdeckplatte für Unterschränke ohne Abdeckplatte  <i>cover panel in variable dimensions for base cabinets without top</i>	200,0 max.	1,6	49,3 max.	<b>ADVF</b>	<b>221</b>
Artikel nicht lieferbar in Weiß Glanz und Anthrazit Glanz / article not available in White Gloss and Anthracite Gloss						

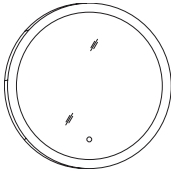
 Regalfarben unbedingt mit angeben, Übersicht siehe Seite 4. Please indicate shelf colours, overview see page 4.

# 3260fair »Spiegelpaneele und Zubehör/mirror panels and accessoires«

Beschreibung Description	Maße in cm Dimensions in cm			Artikel-Nr. Article no.	Türanschlag Door stop	Identnummer ID number
	B/W	H	T/D			
 <p>Spiegelpaneel, Sensorschalter, satiniert, LED Beleuchtung, 4000 K, 17,3 W, 2415 Lumen, EEK G <b>Helligkeit dimmbar</b></p> <p><i>mirror panel, sensor switch, satined, LED-lighting, 4000 K, 17,3 W, 2415 lumen, EEC G</i> <b>brighness dimmable</b></p>	55,0	78,0	2,8	<b>SPE55</b>	  <p>Dieses Produkt enthält eine Lichtquelle der Energieeffizienzklasse G</p>	<b>1131</b>
 <p>Spiegelpaneel, Sensorschalter, satiniert, LED Beleuchtung, 4000 K, 13,5 W, 1890 Lumen, EEK G <b>Helligkeit dimmbar</b></p> <p><i>mirror panel, sensor switch, satined, LED-lighting, 4000 K, 13,5 W, 1890 lumen, EEC G</i> <b>brighness dimmable</b></p>	55,0	55,0	2,8	<b>SPK55</b>	  <p>Dieses Produkt enthält eine Lichtquelle der Energieeffizienzklasse G</p>	<b>992</b>
 <p>Spiegelpaneel, Sensorschalter, satiniert, LED Beleuchtung, 4000 K, 20,8 W, 2905 Lumen, EEK G <b>Helligkeit dimmbar</b></p> <p><i>mirror panel, sensor switch, satined, LED-lighting, 4000 K, 20,8 W, 2905 lumen, EEC G</i> <b>brighness dimmable</b></p>	78,0	78,0	2,8	<b>SPK78</b>	  <p>Dieses Produkt enthält eine Lichtquelle der Energieeffizienzklasse G</p>	<b>1292</b>
 <p>Steckdose/Powerbox für Spiegelschränke Ausführung <b>Schweiz</b> IP44 mit USB-C Stecker</p> <p><i>Power socket for mirror cabinets Switzerland type IP44 with USB-C plug</i></p>				<b>Mehrpreis extra charge</b>		<b>138</b>
 <p>Steckdose/Powerbox für Spiegelschränke Ausführung <b>Frankreich</b> mit USB-C Stecker</p> <p><i>Power socket for mirror cabinets France type with USB-C plug</i></p>				<b>Mehrpreis extra charge</b>		<b>138</b>

EEK/EEC=Energieeffizienzklasse/energy efficiency category  
Leuchtmittel sind nicht austauschbar / illuminants are not interchangeable.

**i** Weiteres Zubehör finden Sie im Register 3970 und Beistellschränke im Register 3990.  
**Further accessoires can be found in register 3970 and side cabinets in register 3990.**







3280cara





## Piktogramme/pictograms



Mineralmarmor Waschtisch  
Marble minerals washbasin



LED Lichtfarbe kalt  
LED colour temperature cold



LED mit Sensorschalter,  
Helligkeit dimmbar  
LED with sensor switch,  
brightness dimmable

## Mineralmarmor Waschtisch weiß alpin Glanz (CB69) Marble minerals washbasin gloss alpine white (CB69)

 ≈ Beckenmaße in cm (BxHxT)  
basin dimensions in cm (WxHxD)

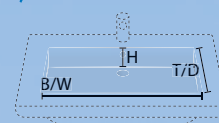

MWCAR9R



MWCAR9L



MWCAR12R



MWCAR12L

alle Becken/all basins =  59,1 x 12x33,7 cm

## Schränke/cabinets 3280cara

### Frontfarben/front colours

#### MDF-foliiert/MDF-coated

449



**Kastanie Graphit Nachbildung**  
*Graphite Chestnut Finish*  
CBC\_

273



**Eiche Struktur Natur Nachbildung**  
*Oak Structure Nature Finish*  
CBM\_

235



**Eiche Struktur Weiß Nachbildung** NEW  
*Oak Structure White Finish*  
CBL\_

226



**Eiche Struktur Braun Nachbildung** NEW  
*Oak Structure Brown Finish*  
CBH\_

961

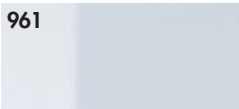

**Weiß Glanz**  
*Gloss White*  
CBG\_

438



**Anthrazit Glanz**  
*Gloss Anthracite*  
CBF\_

### Korpusfarben/basic shell colours

#### PG 2 Dickkante/thick edge

490



**Kastanie Graphit Nachbildung**  
*Graphite Chestnut Finish*  
C/CB45

473



**Eiche Struktur Natur Nachbildung**  
*Oak Structure Nature Finish*  
M/CB55

435



**Eiche Struktur Weiß Nachbildung** NEW  
*Oak Structure White Finish*  
L/CB40

426



**Eiche Struktur Braun Nachbildung** NEW  
*Oak Structure Brown Finish*  
H/CB70

#### PG 3 MDF-foliiert/MDF-coated

042

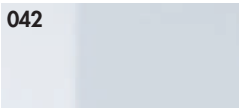

**Weiß Glanz Folie**  
*Gloss White*  
G/CB50

438



**Anthrazit Glanz Folie**  
*Gloss Anthracite*  
F/CB30

## Griffe/handles



### Chrom Glanz

Gloss chrome

Griffnummer/handlenumber: 434/438/439/533/534

⌀-⌀ 324 mm/160 mm/320 mm/160 mm/384 mm

⌀-⌀ = Bohrabstand/hole spacing

**Die Angabe einer Griffnummer ist ausreichend. Die Griffe werden passend zur jeweiligen Schrankbreite beigelegt.**  
*The indication of one handle number is sufficient. The handles are supplied to match the respective cabinet width.*

## Beleuchtung / lighting



### Aufbauleuchte LED

Top light LED











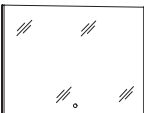



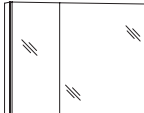

### Lichtfarbe Tageslicht (Kalt)

Luminous colour natural light (cold)



AW90, AWP90,  
AW120, AWP120



**Die Steckdose / Powerbox für Spiegelschränke ist auch in Ausführung für die Schweiz / Frankreich erhältlich. Bitte Mehrpreis beachten (siehe Seite 9).**  
*The power socket for mirror cabinets is also available for Switzerland / France. Please note extra charge (see page 9).*

Beschreibung Description	Maße in cm Dimensions in cm			Artikel-Nr. Article no.	Türanschlag Door stop	Identnummer ID number	
	B/W	H	T/D			PG2	PG3
 <p>Kombination 90 cm bestehend aus: Spiegelpaneel, Sensorschalter Mineralmarmor-Waschtisch, Ablage links Waschtisch-Unterschrank, 2 Auszüge, 1 Tür links</p> <p><i>combination 90 cm width consisting of: mirror panel, sensor switch marble minerals washbasin, storage surface left washbasin base cabinet, 2 extensions 1 door left</i></p>				<b>SPBSA9</b> <b>MWCAR9L</b> <b>WMTAA9</b>	  	<b>1154</b> <b>1016</b> <b>1937</b>	<b>1154</b> <b>1016</b> <b>2168</b>
						<b>4107</b>	<b>4338</b>
 <p>Kombination 90 cm bestehend aus: Spiegelschrank, seitliche LED-Beleuchtung Mineralmarmor-Waschtisch, Ablage links Waschtisch-Unterschrank, 2 Auszüge, 1 Tür links</p> <p><i>combination 90 cm width consisting of: mirror cabinet, lateral LED-lighting marble minerals washbasin, storage surface left washbasin base cabinet, 2 extensions 1 door left</i></p>				<b>SBSA9R</b> <b>MWCAR9L</b> <b>WMTAA9</b>	 	<b>1777</b> <b>1016</b> <b>1937</b>	<b>1777</b> <b>1016</b> <b>2168</b>
						<b>4730</b>	<b>4961</b>
 <p>Kombination 90 cm bestehend aus: Spiegelschrank, seitliche LED-Beleuchtung Regal unter dem Spiegelschrank Mineralmarmor-Waschtisch, Ablage rechts Waschtisch-Unterschrank, 2 Auszüge, 1 Tür rechts</p> <p><i>combination 90 cm width consisting of: mirror cabinet, lateral LED-lighting shelf below the mirror cabinet marble minerals washbasin, storage surface right washbasin base cabinet, 2 extensions, 1 door right</i></p>				<b>SBSA9L</b> <b>SRB9</b> <b>MWCAR9R</b> <b>WMAAT9</b>	 	<b>1777</b> <b>364</b> <b>1016</b> <b>1937</b>	<b>1777</b> <b>364</b> <b>1016</b> <b>2168</b>
						<b>5094</b>	<b>5325</b>
 <p>Kombination 120 cm bestehend aus: Spiegelschrank, seitliche LED-Beleuchtung Regal unter dem Spiegelschrank Mineralmarmor-Waschtisch, Ablage rechts Waschtisch-Unterschrank, 2 Auszüge, 2 Türen</p> <p><i>combination 120 cm width consisting of: mirror cabinet, lateral LED-lighting shelf below the mirror cabinet marble minerals washbasin, storage surface right washbasin base cabinet, 2 extensions, 2 doors</i></p>				<b>SBSA12</b> <b>SRB45</b> <b>MWCAR12R</b> <b>WMAAT12</b>	 	<b>1961</b> <b>266</b> <b>1269</b> <b>2330</b>	<b>1961</b> <b>266</b> <b>1269</b> <b>2583</b>
						<b>5826</b>	<b>6079</b>
 <p>Kombination 120 cm bestehend aus: Spiegelpaneel, Sensorschalter Regale unter und neben dem Paneel Mineralmarmor-Waschtisch, Ablage rechts Waschtisch-Unterschrank, 4 Auszüge</p> <p><i>combination 120 cm width consisting of: mirror cabinet, lateral LED-lighting shelves below and adjacent to mirror marble minerals washbasin, storage surface right washbasin base cabinet, 4 extensions</i></p>				<b>SPBSA12</b> <b>SRB9, REB15</b> <b>MWCAR12R</b> <b>WMAAAA12R</b>	  	<b>1246</b> <b>364, 353</b> <b>1269</b> <b>2791</b>	<b>1246</b> <b>364, 353</b> <b>1269</b> <b>3068</b>
						<b>6023</b>	<b>6300</b>



Handtuchhalter, Regale, Unterbaubeleuchtungen und weiteres Zubehör finden Sie in der Rubrik 3970zubehör.  
Towel rails, shelves, base lightings and other accessories can be found in the 3970accessories range.

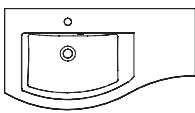

# 3280cara »90 cm R Mineralmarmor/*marble minerals*«

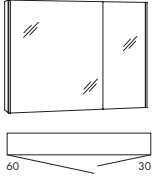

Beschreibung <i>Description</i>	Maße in cm <i>Dimensions in cm</i>			Artikel-Nr. <i>Article no.</i>	Türanschlag <i>Door stop</i>	Identnummer <i>ID number</i>
	B/W	H	T/D			



	Mineralmarmor-Waschtisch <b>Ablage rechts</b> , inkl. Überlauf  <i>marble minerals washbasin depot right, incl. overflow</i>	90,4	2,0	41,5/ 49,5/ 32,8	<b>MWCAR9R</b>  	<b>1016</b>
---	---	------	-----	------------------------	---	-------------

	Waschtisch-Unterschrank 2 Auszüge, 1 Tür rechts, 1 Glaseinlege- boden, <b>Ausschnitt Siphon links</b>  <i>washbasin base cabinet 2 extensions, 1 door right, 1 glass board cutout siphon left</i>	90,0	47,8	40,3/ 48,0/ 32,2	<b>WMAAT9</b>	PG2 <b>1937</b>	PG3 <b>2168</b>
---	---	------	------	------------------------	---------------	--------------------	--------------------

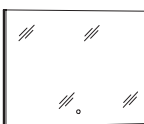
	Spiegelschrank, 2 beidseitig verspiegelte Türen, 2 Glaseinlegeböden, inkl. Schalter/Steckdose, seitliche LED-Beleuchtung, 6000 K, 2x 6,3 W, 2x 660 Lumen, EEK F  <i>mirror cabinet, 2 doors mirrored on both sides, 2 glass boards, incl. switch/socket lateral LED-lighting, 6000 K, 2x 6,3 W, 2x 660 lumen, EEC F</i>	90,0	68,2	17,6	<b>SBSA9L</b>    Dieses Produkt enthält eine Lichtquelle der Energieeffizienzklasse F	<b>1777</b>
--	---	------	------	------	--	-------------

	LED-Aufbauleuchte für Spiegelschrank mit LED-Mini-Stecker, 6000 K, 12,5 W, 1566 Lumen, EEK E  <i>LED-lighting for mirror cabinet with LED-mini-plug, 6000 K, 12,5 W, 1566 lumen, EEC E</i>	90,0	2,4	20,0	<b>AW90</b>    Dieses Produkt enthält eine Lichtquelle der Energieeffizienzklasse E	<b>439</b>
---	--	------	-----	------	--	------------



	Spiegelpanel, Sensorschalter, seitliche LED-Beleuchtung 6000 K, 2x 6,3 W, 2x 660 Lumen, EEK F <b>Helligkeit dimmbar</b>  <i>mirror panel, sensor switch, lateral LED-lighting 6000 K, 2x 6,3 W, 2x 660 lumen, EEC F brighthness dimmable</i>	90,0	68,2	2,8	<b>SPBSA9</b>     Dieses Produkt enthält eine Lichtquelle der Energieeffizienzklasse F	<b>1154</b>
---	---	------	------	-----	---	-------------

	LED-Aufbauleuchte für Spiegelpanel mit LED-Mini-Stecker, 6000 K, 12,5 W, 1566 Lumen, EEK E <b>Helligkeit dimmbar</b>  <i>LED-lighting for mirror panel with LED-mini-plug, 6000 K, 12,5 W, 1566 lumen, EEC E brighthness dimmable</i>	90,0	2,4	10,0	<b>AWP90</b>     Dieses Produkt enthält eine Lichtquelle der Energieeffizienzklasse E	<b>392</b>
---	--	------	-----	------	--	------------



EEK/EEC=Energieeffizienzklasse/energy efficiency category  
Leuchtmittel sind nicht austauschbar / illuminants are not interchangeable.

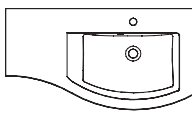

# 3280cara »90 cm L Mineralmarmor/ marble minerals«

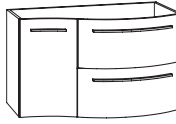
Beschreibung Description	Maße in cm Dimensions in cm			Artikel-Nr. Article no.	Türanschlag Door stop	Identnummer ID number
	B/W	H	T/D			

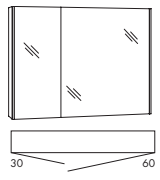

 <p>Mineralmarmor-Waschtisch <b>Ablage links</b>, inkl. Überlauf</p> <p><i>marble minerals washbasin depot left, incl. overflow</i></p>	90,4	2,0	32,8/ 49,5/ 41,5	<b>MWCAR9L</b> 	1016	

 <p>Waschtisch-Unterschrank 2 Auszüge, 1 Tür links, 1 Glaseinlege- boden, <b>Ausschnitt Siphon rechts</b></p> <p><i>washbasin base cabinet 2 extensions, 1 door left, 1 glass board cutout siphon right</i></p>	90,0	47,8	32,2/ 48,0/ 40,3	<b>WMTAA9</b>	1937		2168	
					PG2	PG3		

 <p>Spiegelschrank, 2 beidseitig verspiegelte Türen, 2 Glaseinlegeböden, inkl. Schalter/Steckdose, seitliche LED-Beleuchtung, 6000 K, 2x 6,3 W, 2x 660 Lumen, EEK F</p> <p><i>mirror cabinet, 2 doors mirrored on both sides, 2 glass boards, incl. switch/socket lateral LED-lighting, 6000 K, 2x 6,3 W, 2x 660 lumen, EEC F</i></p>	90,0	68,2	17,6	<b>SBSA9R</b> 	1777			
					Dieses Produkt enthält eine Lichtquelle der Energieeffizienzklasse F			

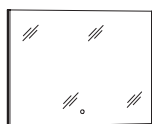
 <p>LED-Aufbauleuchte für Spiegelschrank mit LED-Mini-Stecker, 6000 K, 12,5 W, 1566 Lumen, EEK E</p> <p><i>LED-lighting for mirror cabinet with LED-mini-plug, 6000 K, 12,5 W, 1566 lumen, EEC E</i></p>	90,0	2,4	20,0	<b>AW90</b> 	439			
					Dieses Produkt enthält eine Lichtquelle der Energieeffizienzklasse E			

 <p>Spiegelpaneel, Sensorschalter, seitliche LED-Beleuchtung 6000 K, 2x 6,3 W, 2x 660 Lumen, EEK F <b>Helligkeit dimmbar</b></p> <p><i>mirror panel, sensor switch, lateral LED-lighting 6000 K, 2x 6,3 W, 2x 660 lumen, EEC F brighness dimmable</i></p>	90,0	68,2	2,8	<b>SPBSA9</b>  	1154			
					Dieses Produkt enthält eine Lichtquelle der Energieeffizienzklasse F			











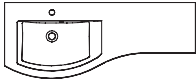

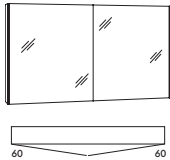

 <p>LED-Aufbauleuchte für Spiegelpaneel mit LED-Mini-Stecker, 6000 K, 12,5 W, 1566 Lumen, EEK E <b>Helligkeit dimmbar</b></p> <p><i>LED-lighting for mirror panel with LED-mini-plug, 6000 K, 12,5 W, 1566 lumen, EEC E brighness dimmable</i></p>	90,0	2,4	10,0	<b>AWP90</b>  	392			
					Dieses Produkt enthält eine Lichtquelle der Energieeffizienzklasse E			

EEK/EEC=Energieeffizienzklasse/energy efficiency category  
Leuchtmittel sind nicht austauschbar / illuminants are not interchangeable.

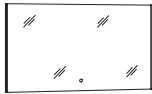

# 3280cara »120 cm R Mineralmarmor/marble minerals«



Beschreibung Description	Maße in cm Dimensions in cm			Artikel-Nr. Article no.	Türanschlag Door stop	Identnummer ID number
	B/W	H	T/D			

	Mineralmarmor-Waschtisch <b>Ablage rechts</b> , inkl. Überlauf  <i>marble minerals washbasin depot right, incl. overflow</i>	120,4	2,0	41,5/ 49,5/ 32,8	<b>MWCAR12R</b> 	<b>1269</b>
						PG2
	Waschtisch-Unterschrank 2 Auszüge, 2 Türen, 2 Glaseinlegeböden Türanschlag Rechts/Rechts  <i>washbasin base cabinet 2 extensions, 2 doors, 2 glass boards door stop right/right</i>	120,0	47,8	40,3/ 48,0/ 32,2	<b>WMAAT12</b>	<b>2330</b>
						PG3
	Waschtisch-Unterschrank 4 Auszüge  <i>washbasin base cabinet 4 extensions</i>	120,0	47,8	40,3/ 48,0/ 32,2	<b>WMAAAA12R</b>	<b>2791</b>
						<b>3068</b>
	Spiegelschrank, 2 beidseitig verspiegelte Türen, 4 Glaseinlegeböden, inkl. Schalter/Steckdose, seitliche LED-Beleuchtung, 6000 K, 2x 6,3 W, 2x 660 Lumen, EEK F  <i>mirror cabinet, 2 doors mirrored on both sides, 4 glass boards, incl. switch/socket lateral LED-lighting, 6000 K, 2x 6,3 W, 2x 660 lumen, EEC F</i>	120,0	68,2	17,6	<b>SBSA12</b> 	<b>1961</b>
						Dieses Produkt enthält eine Lichtquelle der Energieeffizienzklasse F
	LED-Aufbauleuchte für Spiegelschrank mit LED-Mini-Stecker, 6000 K, 16,8 W, 2106 Lumen, EEK E  <i>LED-lighting for mirror cabinet with LED-mini-plug, 6000 K, 16,8 W, 2106 lumen, EEC E</i>	120,0	2,4	20,0	<b>AW120</b> 	<b>485</b>
						Dieses Produkt enthält eine Lichtquelle der Energieeffizienzklasse E
	Spiegelpaneel, Sensorschalter, seitliche LED-Beleuchtung 6000 K, 2x 6,3 W, 2x 660 Lumen, EEK F <b>Helligkeit dimmbar</b>  <i>mirror panel, sensor switch, lateral LED-lighting 6000 K, 2x 6,3 W, 2x 660 lumen, EEC F brightness dimmable</i>	120,0	68,2	2,8	<b>SPBSA12</b>  	<b>1246</b>
						Dieses Produkt enthält eine Lichtquelle der Energieeffizienzklasse F
	LED-Aufbauleuchte für Spiegelpaneel mit LED-Mini-Stecker, 6000 K, 17,3 W, 2160 Lumen, EEK E <b>Helligkeit dimmbar</b>  <i>LED-lighting for mirror panel with LED-mini-plug, 6000 K, 17,3 W, 2160 lumen, EEC E brightness dimmable</i>	120,0	2,4	10,0	<b>AWP120</b>  	<b>439</b>
						Dieses Produkt enthält eine Lichtquelle der Energieeffizienzklasse E



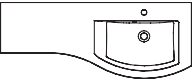

EEK/EEC=Energieeffizienzklasse/energy efficiency category  
Leuchtmittel sind nicht austauschbar / illuminants are not interchangeable.



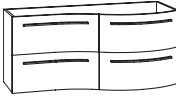

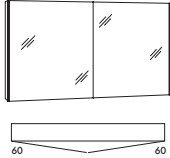

# 3280cara »120 cm L Mineralmarmor/*marble minerals*«

Beschreibung <i>Description</i>	Maße in cm <i>Dimensions in cm</i>			Artikel-Nr. <i>Article no.</i>	Türanschlag <i>Door stop</i>	Identnummer <i>ID number</i>
	B/W	H	T/D			

	Mineralmarmor-Waschtisch <b>Ablage links</b> , inkl. Überlauf  <i>marble minerals washbasin depot left, incl. overflow</i>	120,4	2,0	32,8/ 49,5/ 41,5	<b>MWCAR12L</b> 	<b>1269</b>
--	---	-------	-----	------------------------	--	-------------



						PG2	PG3
	Waschtisch-Unterschrank 2 Auszüge, 2 Türen, 2 Glaseinlegeböden Türanschlag Links/Links  <i>washbasin base cabinet 2 extensions, 2 doors, 2 glass boards door stop left/left</i>	120,0	47,8	32,2/ 48,0/ 40,3	<b>WMTAA12</b>	<b>2330</b>	<b>2583</b>
	Waschtisch-Unterschrank 4 Auszüge  <i>washbasin base cabinet 4 extensions</i>	120,0	47,8	32,2/ 48,0/ 40,3	<b>WMAAAA12L</b>	<b>2791</b>	<b>3068</b>

	Spiegelschrank, 2 beidseitig verspiegelte Türen, 4 Glaseinlegeböden, inkl. Schalter/Steckdose, seitliche LED-Beleuchtung, 6000 K, 2x 6,3 W, 2x 660 Lumen, EEK F  <i>mirror cabinet, 2 doors mirrored on both sides, 4 glass boards, incl. switch/socket lateral LED-lighting, 6000 K, 2x 6,3 W, 2x 660 lumen, EEC F</i>	120,0	68,2	17,6	<b>SBSA12</b> 	<b>1961</b>	
	LED-Aufbauleuchte für Spiegelschrank mit LED-Mini-Stecker, 6000 K, 16,8 W, 2106 Lumen, EEK E  <i>LED-lighting for mirror cabinet with LED-mini-plug, 6000 K, 16,8 W, 2106 lumen, EEC E</i>	120,0	2,4	20,0	<b>AW120</b> 	<b>485</b>	
						Dieses Produkt enthält eine Lichtquelle der Energieeffizienzklasse F	
						Dieses Produkt enthält eine Lichtquelle der Energieeffizienzklasse E	

	Spiegelpaneel, Sensorschalter, seitliche LED-Beleuchtung 6000 K, 2x 6,3 W, 2x 660 Lumen, EEK F <b>Helligkeit dimmbar</b>  <i>mirror panel, sensor switch, lateral LED-lighting 6000 K, 2x 6,3 W, 2x 660 lumen, EEC F brightness dimmable</i>	120,0	68,2	2,8	<b>SPBSA12</b>  	<b>1246</b>	
	LED-Aufbauleuchte für Spiegelpaneel mit LED-Mini-Stecker, 6000 K, 17,3 W, 2160 Lumen, EEK E <b>Helligkeit dimmbar</b>  <i>LED-lighting for mirror panel with LED-mini-plug, 6000 K, 17,3 W, 2160 lumen, EEC E brightness dimmable</i>	120,0	2,4	10,0	<b>AWP120</b>  	<b>439</b>	
						Dieses Produkt enthält eine Lichtquelle der Energieeffizienzklasse F	
						Dieses Produkt enthält eine Lichtquelle der Energieeffizienzklasse E	

EEK/EEC=Energieeffizienzklasse/energy efficiency category  
Leuchtmittel sind nicht austauschbar / illuminants are not interchangeable.

Beschreibung Description	Maße in cm Dimensions in cm			Artikel-Nr. Article no.	Türanschlag Door stop	Identnummer ID number
	B/W	H	T/D			

	Schubkasteneinsatz (Kunststoff) für oberen Auszug vom WT-Unterschrank  <i>drawer insert part (plastic) for top drawer from base cabinet</i>	36,1	4,3	34,0	<b>SCMBEG3</b>	<b>69</b>
	Steckdose/Powerbox für Spiegelschränke Ausführung <b>Schweiz</b> IP44 mit USB-C Stecker  <i>Power socket for mirror cabinets Switzerland type IP44 with USB-C plug</i>				<b>Mehrpreis extra charge</b>	<b>138</b>
	Steckdose/Powerbox für Spiegelschränke Ausführung <b>Frankreich</b> mit USB-C Stecker  <i>Power socket for mirror cabinets France type with USB-C plug</i>				<b>Mehrpreis extra charge</b>	<b>138</b>

**i** Weiteres Zubehör finden Sie im Register 3970 und Beistellschränke im Register 3990.  
*Further accessoires can be found in register 3970 and side cabinets in register 3990.*





3290fair





# »3290fair«

## Piktogramme/pictograms



Keramik Waschtisch  
Ceramic washbasin



LED Lichtfarbe kalt  
LED colour temperature cold



LED mit Sensorschalter,  
Helligkeit dimmbar  
LED with sensor switch,  
brightness dimmable



LED Lichtfarbe warm  
LED colour temperature warm

## Keramik Waschtisch weiß alpin Glanz (PGK) Ceramic washbasin gloss alpine white (PGK)

 ≈ Beckenmaße in cm (BxHxT)  
basin dimensions in cm (WxHxD)

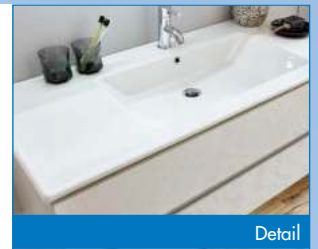
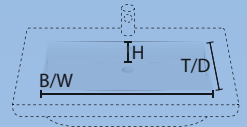

KWCHR8 |  51 x 13,5 x 32,5 cm



KWCHR10 |  51 x 13,5 x 32,5 cm



KWCHR12 |  51 x 13,5 x 32,5 cm



KWCHR12D |  42 x 11,5 x 32,5 cm

**!** Diese Keramikwaschtische benötigen keine Wandbefestigung.  
These ceramic basins do not require wall mounting.

# »3290fair«

## Keramik Waschtisch weiß alpin Glanz mit Dekorkante (PGK) Ceramic washbasin gloss alpine white with decor edge (PGK)

≈ Beckenmaße in cm (BxHxT)  
basin dimensions in cm (WxHxD)

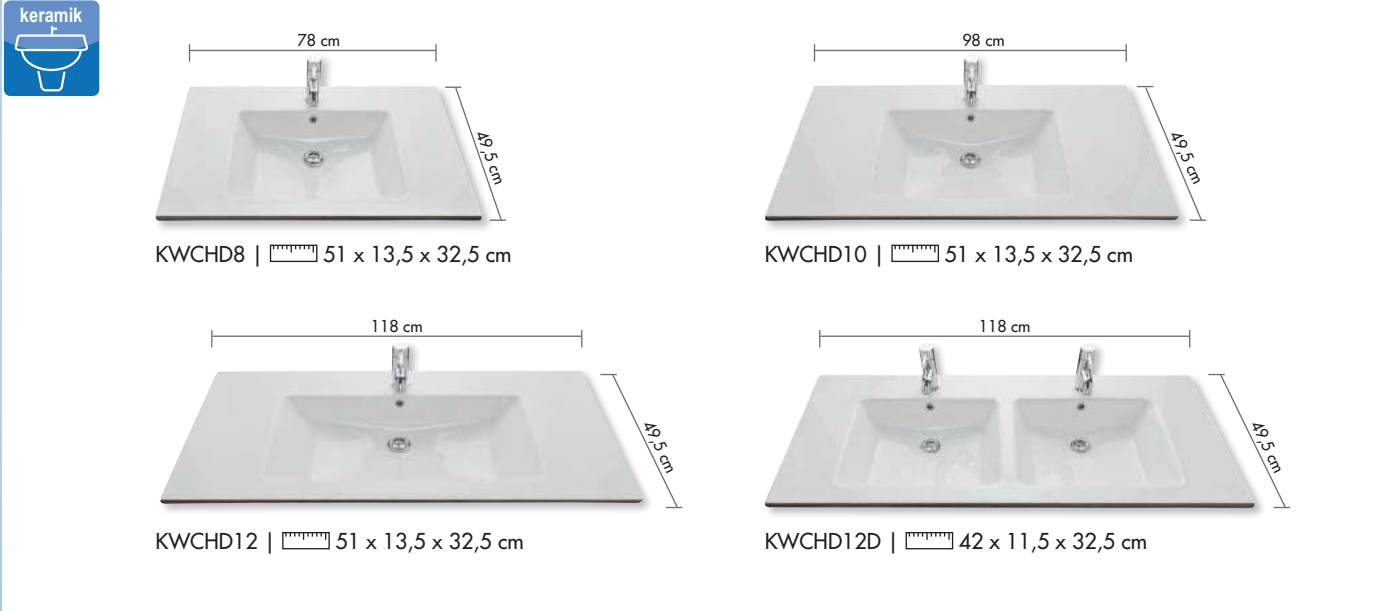
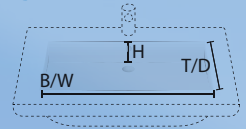

! Diese Keramikwaschtische benötigen keine Wandbefestigung.  
These ceramic basins do not require wall mounting.

### Dekorkanten-Farben/decor edge colours

284

**Anthrazit Seidenglanz**  
Silk Gloss Anthracite  
PG84

490

**Kastanie Graphit Nachbildung**  
Graphite Chestnut Finish  
PG45

473

**Eiche Struktur Natur Nachbildung**  
Oak Structure Nature Finish  
PG55

435

**Eiche Struktur Weiß Nachbildung** NEW  
Oak Structure White Finish  
PG40

426

**Eiche Struktur Braun Nachbildung** NEW  
Oak Structure Brown Finish  
PG70



Ohne Dekorkante/without decorative edge



Mit Dekorkante/with decorative edge



Mit Dekorkante/with decorative edge

#### Vorteil: PUR-Verklebung

Die Dekorkanten werden mit einem PUR-Kleber (Polyurethankleber) in einem industriellen Verfahren auf die Waschtische aufgebracht. Klebstoffe auf Polyurethan-Basis bieten vielfältige Einsatzmöglichkeiten und ein breites Spektrum an Eigenschaften für diese Anwendung:

- Dauerhaft mit hoher Scherfestigkeit
- Dauerhaft Wasserfest

#### Advantage: PUR bonding

The decorative edges are applied to the washbasins with a PUR glue (polyurethane adhesive) in an industrial process. Polyurethane based adhesives offer a variety of uses and a huge range of properties for this application:

- Permanently with high shear strength
- Permanently waterproof



## Schränke/cabinets 3290fair

### Frontfarben/front colours

#### Dickkante/thick edge

286



**Weiß Seidenglanz**  
Silk Gloss White  
PGE\_

284



**Anthrazit Seidenglanz**  
Silk Gloss Anthracite  
PGA\_

490



**Kastanie Graphit Nachbildung**  
Graphite Chestnut Finish  
PGC\_

473



**Eiche Struktur Natur Nachbildung**  
Oak Structure Nature Finish  
PGM\_

435



**Eiche Struktur Weiß Nachbildung** NEW  
Oak Structure White Finish  
PGL\_

426



**Eiche Struktur Braun Nachbildung** NEW  
Oak Structure Brown Finish  
PGH\_

### Korpusfarben/basic shell colours

#### PG 1 Dickkante/thick edge

286



**Weiß Seidenglanz**  
Silk Gloss White  
E/PG86

284



**Anthrazit Seidenglanz**  
Silk Gloss Anthracite  
A/PG84

490



**Kastanie Graphit Nachbildung**  
Graphite Chestnut Finish  
C/PG45

473



**Eiche Struktur Natur Nachbildung**  
Oak Structure Nature Finish  
M/PG55

435



**Eiche Struktur Weiß Nachbildung** NEW  
Oak Structure White Finish  
L/PG40

426



**Eiche Struktur Braun Nachbildung** NEW  
Oak Structure Brown Finish  
H/PG70

## Regalfarben/shelf colours

287

**Weiß Seidenglanz**  
Silk Gloss White  
PG86

285

**Anthrazit Seidenglanz**  
Silk Gloss Anthracite  
PG84

491

**Kastanie Graphit Nachbildung**  
Graphite Chestnut Finish  
PG45

474

**Eiche Struktur Natur Nachbildung**  
Oak Structure Nature Finish  
PG55

436

**Eiche Struktur Weiß Nachbildung** NEW  
Oak Structure White Finish  
PG40

427

**Eiche Struktur Braun Nachbildung** NEW  
Oak Structure Brown Finish  
PG70

## Griffleiste/handle bar



**Aluminium Matt**  
Matt aluminium

## Beleuchtung / lighting



**Aufbauleuchte LED**  
Top light LED

**Lichfarbe Tageslicht (Kalt)**  
Luminous colour natural light (cold)



AW80, AWP80,  
AW100, AWP100  
AW120, AWP120



**Seitlich und oben LED Beleuchtung**  
lateral and top LED lighting



Die Steckdose / Powerbox für Spiegelschränke ist auch in Ausführung für die Schweiz / Frankreich erhältlich. Bitte Mehrpreis beachten (siehe Seite 17).  
The power socket for mirror cabinets is also available for Switzerland / France. Please note extra charge (see page 17).





# 3290fair »Beispiel-Kombinationen/example-combinations«



Beschreibung Description	Maße in cm Dimensions in cm			Artikel-Nr. Article no.	Türanschlag Door stop	Identnummer ID number
	B/W	H	T/D			
PG1						
  <p>Kombination 80 cm bestehend aus: Spiegelschrank, seitliche LED-Beleuchtung Keramik Waschtisch Waschtisch-Unterschrank, 1 Schubkasten Designsiphon</p> <p><i>combination 80 cm width consisting of: mirror cabinet, lateral LED-lighting ceramic washbasin washbasin base cabinet, 1 drawer design siphon</i></p>				<b>SADA8L</b> <b>KWCHR8</b> <b>GWKHS7</b> <b>DS</b>	 	1707 877 830 236 <hr/> 3650
  <p>Kombination 80 cm bestehend aus: Spiegelschrank, seitliche LED-Beleuchtung Keramik Waschtisch Waschtisch-Unterschrank, 1 feste Blende, 1 Schubkasten</p> <p><i>combination 80 cm width consisting of: mirror cabinet, lateral LED-lighting ceramic washbasin washbasin base cabinet, 1 fixed cover, 1 drawer</i></p>				<b>SADA8L</b> <b>KWCHR8</b> <b>GWKHBS7</b>	 	1707 877 900 <hr/> 3484
  <p>Kombination 120 cm bestehend aus: Spiegelschrank, seitliche LED-Beleuchtung Winkelablage unter dem Spiegelschrank Keramik Waschtisch Waschtisch-Unterschrank, 1 Schubkasten, 1 Auszug</p> <p><i>combination 120 cm width consisting of: mirror cabinet, lateral LED-lighting angled shelf under mirror cabinet ceramic washbasin washbasin base cabinet, 1 drawer, 1 extension</i></p>				<b>SADA12</b> <b>SRP6</b> <b>KWCHR12</b> <b>GWKHS11</b>	 	2168 253 2053 1569 <hr/> 6043
  <p>Kombination 180 cm bestehend aus: Spiegelpaneel, Sensorschalter Regal unter dem Spiegelpaneel Regal neben dem Spiegelpaneel Keramik Waschtisch Waschtisch-Unterschrank, 1 Schubkasten, 1 Auszug</p> <p><i>combination 180 cm width consisting of: mirror cabinet, lateral LED-lighting shelf below mirror cabinet shelf besides mirror cabinet ceramic washbasin washbasin base cabinet, 1 drawer, 1 extension</i></p>				<b>SPBSA12</b> <b>SRB12-66</b> <b>SRB45</b> <b>KWCHR12</b> <b>GWKHS11</b>	  	1292 417 266 2053 1569 <hr/> 5597
  <p>Kombination 180 cm bestehend aus: Spiegelschrank, seitliche LED-Beleuchtung Regal neben dem Spiegelschrank Winkelablage unter dem Spiegelschrank Keramik Waschtisch Waschtisch-Unterschrank, 1 feste Blende, 1 Schubkasten Unterschrank, 2 Auszüge Unterschrank, 2 Auszüge</p> <p><i>combination 180 cm width consisting of: mirror cabinet, lateral LED-lighting side shelf adjacent to mirror cabinet angled shelf below mirror cabinet ceramic washbasin washbasin base cabinet, 1 fixed cover, 1 drawer base cabinet, 2 extensions base cabinet, 2 extensions</i></p>				<b>SADA12</b> <b>REB20</b> <b>SRP6</b> <b>KWCHR10</b> <b>GWKHS9</b> <b>GUHAA4F</b> <b>GUHAA4F</b>	 	2168 378 253 1038 969 1085 1085 <hr/> 6976

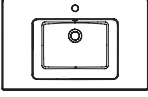

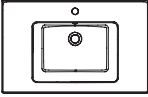

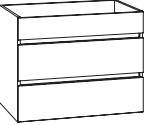

Handtuchhalter, Regale, Unterbaubeleuchtungen und weiteres Zubehör finden Sie in der Rubrik 3970zubehör.  
Towel rails, shelves, base lightings and other accessories can be found in the 3970accessories range.

# 3290fair »80 cm Keramik/ceramic«

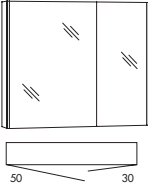
Beschreibung Description	Maße in cm Dimensions in cm			Artikel-Nr. Article no.	Türanschlag Door stop	Identnummer ID number
	B/W	H	T/D			

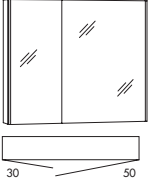
	Keramik-Waschtisch inkl. Überlauf  <i>ceramic washbasin incl. overflow</i>	81,0	1,5	51,0	<b>KWCHR8</b> 	<b>877</b>
	Keramik-Waschtisch <b>mit Dekorkante</b> inkl. Überlauf  <i>ceramic washbasin <b>with decor edge</b> incl. overflow</i>	78,0	1,5	49,5	<b>KWCHD8</b> 	<b>1569</b>

						PG1
	Waschtisch-Unterschrank 1 Schubkasten  <i>washbasin base cabinet 1 drawer</i>	77,0	23,8	49,3	<b>GWKHS7</b>	<b>830</b>
	Waschtisch-Unterschrank 1 feste Blende, 1 Schubkasten  <i>washbasin base cabinet 1 fixed cover, 1 drawer</i>	77,0	36,6	49,3	<b>GWKHBS7</b>	<b>900</b>
	Waschtisch-Unterschrank 1 Schubkasten, 1 Auszug  <i>washbasin base cabinet 1 drawer, 1 extension</i>	77,0	47,8	49,3	<b>GWKHSA7</b>	<b>1269</b>
	Waschtisch-Unterschrank 1 feste Blende, 1 Schubkasten, 1 Auszug  <i>washbasin base cabinet 1 fixed cover, 1 drawer, 1 extension</i>	77,0	60,6	49,3	<b>GWKHBSA7</b>	<b>1407</b>









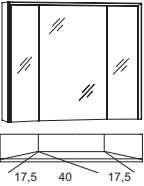

	Spiegelschrank, 2 beidseitig verspiegelte Türen, 2 Glaseinlegeböden, inkl. Schalter/ Steckdose, seitliche LED-Beleuchtung, 6000 K, 2x 6,3 W, 2x 660 Lumen, EEK F  <i>mirror cabinet, 2 doors mirrored on both sides, 2 glass boards, incl. switch/socket lateral LED-lighting, 6000 K, 2x 6,3 W, 2x 660 lumen, EEC F</i>	80,0	68,2	17,6	<b>SADA8L</b>   Dieses Produkt enthält eine Lichtquelle der Energieeffizienzklasse F	<b>1707</b>
	Spiegelschrank, 2 beidseitig verspiegelte Türen, 2 Glaseinlegeböden, inkl. Schalter/ Steckdose, seitliche LED-Beleuchtung, 6000 K, 2x 6,3 W, 2x 660 Lumen, EEK F  <i>mirror cabinet, 2 doors mirrored on both sides, 2 glass boards, incl. switch/socket lateral LED-lighting, 6000 K, 2x 6,3 W, 2x 660 lumen, EEC F</i>	80,0	68,2	17,6	<b>SADA8R</b>   Dieses Produkt enthält eine Lichtquelle der Energieeffizienzklasse F	<b>1707</b>
	LED-Aufbauleuchte für Spiegelschrank mit LED-Mini-Stecker, 6000 K, 10,8 W, 1350 Lumen, EEK E  <i>LED-lighting for mirror cabinet with LED-mini-plug, 6000 K, 10,8 W, 1350 lumen, EEC E</i>	80,0	2,4	20,0	<b>AW80</b>   Dieses Produkt enthält eine Lichtquelle der Energieeffizienzklasse E	<b>415</b>

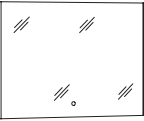
EEK/EEC=Energieeffizienzklasse/energy efficiency category  
Leuchtmittel sind nicht austauschbar / illuminants are not interchangeable.

 Dekorkantenfarben unbedingt mit angeben, Übersicht siehe Seite 2. Please indicate decor edge colours, overview see page 2.

# 3290fair »80 cm Keramik/ceramic«





Beschreibung Description	Maße in cm Dimensions in cm			Artikel-Nr. Article no.	Türanschlag Door stop	Identnummer ID number
	B/W	H	T/D			



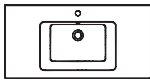

	<p>Spiegelschrank, 3 Spiegeltüren - davon 2 trapezförmig angeordnet, 6 Glaseinlegeböden, inkl. Schalter/Steckdose, <b>seitlich und oben LED-Beleuchtung</b>, 6000 K, 17,2 W, 960 Lumen, EEK E</p> <p><i>mirror cabinet, 3 mirror doors - 2 of them are arranged in a trapeze, 6 glass shelves, incl. switch/socket, <b>lateral and top LED lighting</b>, 6000 K, 17,2 W, 960 lumen, EEC E</i></p>	80,0	68,2	17,6	<p><b>SDU8</b></p>  <p>Dieses Produkt enthält eine Lichtquelle der Energieeffizienzklasse E</p>	<b>2238</b>
	<p>Spiegelpaneel, Sensorschalter, seitliche LED-Beleuchtung 6000 K, 2x 6,3 W, <b>Helligkeit dimmbar</b></p> <p><i>mirror panel, sensor switch, lateral LED-lighting 6000 K, 2x 6,3 W, <b>brighness dimmable</b></i></p>	80,0	68,2	2,8	<p><b>SPBSA8</b></p>    <p>Dieses Produkt enthält eine Lichtquelle der Energieeffizienzklasse F</p>	<b>1154</b>
	<p>LED-Aufbauleuchte für Spiegelpaneel mit LED-Mini-Stecker, 6000 K, 10,8 W, 1350 Lumen, EEK E <b>Helligkeit dimmbar</b></p> <p><i>LED-lighting for mirror panel with LED-mini-plug, 6000 K, 10,8 W, 1350 lumen, EEC E <b>brighness dimmable</b></i></p>	80,0	2,4	10,0	<p><b>AWP80</b></p>    <p>Dieses Produkt enthält eine Lichtquelle der Energieeffizienzklasse E</p>	<b>370</b>

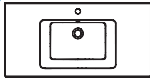



EEK/EEC=Energieeffizienzklasse/energy efficiency category  
Leuchtmittel sind nicht austauschbar / illuminants are not interchangeable.

# 3290fair »100 cm Keramik/ceramic«

Beschreibung Description	Maße in cm Dimensions in cm			Artikel-Nr. Article no.	Türanschlag Door stop	Identnummer ID number
	B/W	H	T/D			

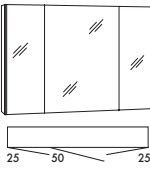
	Keramik-Waschtisch inkl. Überlauf  <i>ceramic washbasin incl. overflow</i>	101,0	1,5	51,0	<b>KWCHR10</b> 		<b>1038</b>
	Keramik-Waschtisch <b>mit Dekorkante</b> inkl. Überlauf  <i>ceramic washbasin <b>with decor edge</b> incl. overflow</i>	98,0	1,5	49,5	<b>KWCHD10</b> 		<b>1753</b>

							PG1
	Waschtisch-Unterschrank 1 Schubkasten  <i>washbasin base cabinet 1 drawer</i>	97,0	23,8	49,3	<b>GWKHS9</b>		<b>877</b>
	Waschtisch-Unterschrank 1 feste Blende, 1 Schubkasten  <i>washbasin base cabinet 1 fixed cover, 1 drawer</i>	97,0	36,6	49,3	<b>GWKHBS9</b>		<b>969</b>
	Waschtisch-Unterschrank 1 Schubkasten, 1 Auszug  <i>washbasin base cabinet 1 drawer, 1 extension</i>	97,0	47,8	49,3	<b>GWKHS A9</b>		<b>1384</b>
	Waschtisch-Unterschrank 1 feste Blende, 1 Schubkasten, 1 Auszug  <i>washbasin base cabinet 1 fixed cover, 1 drawer, 1 extension</i>	97,0	60,6	49,3	<b>GWKHBS A9</b>		<b>1522</b>









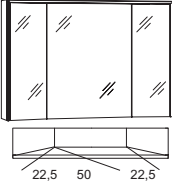

	Spiegelschrank, 3 beidseitig verspiegelte Türen, 4 Glaseinlegeböden, inkl. Schalter/ Steckdose, seitliche LED-Beleuchtung, 6000 K, 2x 6,3 W, 2x 660 Lumen, EEK F  <i>mirror cabinet, 3 doors mirrored on both sides, 4 glass boards, incl. switch/socket lateral LED-lighting, 6000 K, 2x 6,3 W, 2x 660 lumen, EEC F</i>	100,0	68,2	17,6	<b>SADA10</b> 		<b>2076</b>
	LED-Aufbauleuchte für Spiegelschrank mit LED-Mini-Stecker, 6000 K, 13,8 W, 1728 Lumen, EEK E  <i>LED-lighting for mirror cabinet with LED-mini-plug, 6000 K, 13,8 W, 1728 lumen, EEC E</i>	100,0	2,4	20,0	<b>AW100</b> 	Dieses Produkt enthält eine Lichtquelle der Energieeffizienzklasse F	<b>461</b>

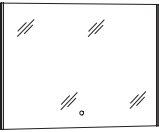
EEK/EEC=Energieeffizienzklasse/energy efficiency category  
Leuchtmittel sind nicht austauschbar / illuminants are not interchangeable.

 Dekorkantenfarben unbedingt mit angeben, Übersicht siehe Seite 2. Please indicate decor edge colours, overview see page 2.

# 3290fair »100 cm Keramik/ceramic«





Beschreibung Description	Maße in cm Dimensions in cm			Artikel-Nr. Article no.	Türanschlag Door stop	Identnummer ID number
	B/W	H	T/D			



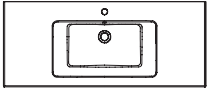

	<p>Spiegelschrank, 3 Spiegeltüren - davon 2 trapezförmig angeordnet, 6 Glaseinlegeböden, inkl. Schalter/Steckdose, <b>seitlich und oben LED-Beleuchtung</b>, 6000 K, 18,7 W, 960 Lumen, EEK E</p> <p><i>mirror cabinet, 3 mirror doors - 2 of them are arranged in a trapeze, 6 glass shelves, incl. switch/socket, <b>lateral and top LED lighting</b>, 6000 K, 18,7 W, 960 lumen, EEC E</i></p>	100,0	68,2	17,6	<p><b>SDU10</b></p>  <p>Dieses Produkt enthält eine Lichtquelle der Energieeffizienzklasse E</p>	2376
	<p>Spiegelpaneel, Sensorschalter, seitliche LED-Beleuchtung 6000 K, 2x 6,3 W, <b>Helligkeit dimmbar</b></p> <p><i>mirror panel, sensor switch, lateral LED-lighting 6000 K, 2x 6,3 W, <b>brighness dimmable</b></i></p>	100,0	68,2	2,8	<p><b>SPBSA10</b></p>    <p>Dieses Produkt enthält eine Lichtquelle der Energieeffizienzklasse F</p>	1246
	<p>LED-Aufbauleuchte für Spiegelpaneel mit LED-Mini-Stecker, 6000 K, 13,7 W, 1440 Lumen, EEK F <b>Helligkeit dimmbar</b></p> <p><i>LED-lighting for mirror panel with LED-mini-plug, 6000 K, 13,7 W, 1440 lumen, EEC F <b>brighness dimmable</b></i></p>	100,0	2,4	10,0	<p><b>AWP100</b></p>    <p>Dieses Produkt enthält eine Lichtquelle der Energieeffizienzklasse F</p>	415

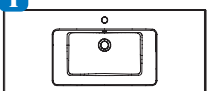



EEK/EEC=Energieeffizienzklasse/energy efficiency category  
Leuchtmittel sind nicht austauschbar / illuminants are not interchangeable.

# 3290fair »120 cm Keramik/ceramic«

Beschreibung Description	Maße in cm Dimensions in cm			Artikel-Nr. Article no.	Türanschlag Door stop	Identnummer ID number
	B/W	H	T/D			

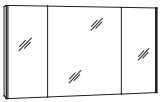
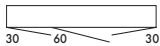
	Keramik-Waschtisch inkl. Überlauf <i>ceramic washbasin incl. overflow</i>	121,0	1,5	51,0	<b>KWCHR12</b> 	<b>2053</b>
	Keramik-Waschtisch <b>mit Dekorkante</b> inkl. Überlauf <i>ceramic washbasin <b>with decor edge</b> incl. overflow</i>	118,0	1,5	49,5	<b>KWCHD12</b> 	<b>2976</b>

						PG1
	Waschtisch-Unterschrank 1 Schubkasten <i>washbasin base cabinet 1 drawer</i>	117,0	23,8	49,3	<b>GWKHS11</b>	<b>992</b>
	Waschtisch-Unterschrank 1 feste Blende, 1 Schubkasten <i>washbasin base cabinet 1 fixed cover, 1 drawer</i>	117,0	36,6	49,3	<b>GWKHS11</b>	<b>1107</b>
	Waschtisch-Unterschrank 1 Schubkasten, 1 Auszug <i>washbasin base cabinet 1 drawer, 1 extension</i>	117,0	47,8	49,3	<b>GWKHS11</b>	<b>1569</b>
	Waschtisch-Unterschrank 1 feste Blende, 1 Schubkasten, 1 Auszug <i>washbasin base cabinet 1 fixed cover, 1 drawer, 1 extension</i>	117,0	60,6	49,3	<b>GWKHS11</b>	<b>1730</b>







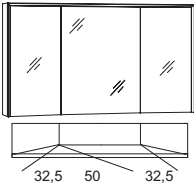

 	Spiegelschrank, 3 beidseitig verspiegelte Türen, 6 Glaseinlegeböden, inkl. Schalter/ Steckdose, seitliche LED-Beleuchtung, 6000 K, 2x 6,3 W, 2x 660 Lumen, EEK F <i>mirror cabinet, 3 doors mirrored on both sides, 6 glass boards, incl. switch/socket lateral LED-lighting, 6000 K, 2x 6,3 W, 2x 660 lumen, EEC F</i>	120,0	68,2	17,6	<b>SADA12</b>   Dieses Produkt enthält eine Lichtquelle der Energieeffizienzklasse F	<b>2168</b>
	LED-Aufbauleuchte für Spiegelschrank mit LED-Mini-Stecker, 6000 K, 16,8 W, 2106 Lumen, EEK E <i>LED-lighting for mirror cabinet with LED-mini-plug, 6000 K, 16,8 W, 2106 lumen, EEC E</i>	120,0	2,4	20,0	<b>AW120</b>   Dieses Produkt enthält eine Lichtquelle der Energieeffizienzklasse E	<b>485</b>

EEK/EEC=Energieeffizienzklasse/energy efficiency category  
Leuchtmittel sind nicht austauschbar / illuminants are not interchangeable.

 Dekorkantenfarben unbedingt mit angeben, Übersicht siehe Seite 2. Please indicate decor edge colours, overview see page 2.



# 3290fair »120 cm Keramik/ceramic«





Beschreibung Description	Maße in cm Dimensions in cm			Artikel-Nr. Article no.	Türanschlag Door stop	Identnummer ID number
	B/W	H	T/D			
 <p>Spiegelschrank, 3 Spiegeltüren - davon 2 trapezförmig angeordnet, 6 Glaseinlegeböden, inkl. Schalter/Steckdose, <b>seitlich und oben LED-Beleuchtung</b>, 6000 K, 20,3 W, 960 Lumen, EEK E</p> <p><i>mirror cabinet, 3 mirror doors - 2 of them are arranged in a trapeze, 6 glass shelves, incl. switch/socket, <b>lateral and top LED lighting</b>, 6000 K, 20,3 W, 960 lumen, EEC E</i></p>	120,0	68,2	17,6	<b>SDU12</b>		<b>2492</b>
Dieses Produkt enthält eine Lichtquelle der Energieeffizienzklasse E						
 <p>Spiegelpaneel, Sensorschalter, seitliche LED-Beleuchtung 6000 K, 2x 6,3 W, <b>Helligkeit dimmbar</b></p> <p><i>mirror panel, sensor switch, lateral LED-lighting 6000 K, 2x 6,3 W, <b>brighness dimmable</b></i></p>	120,0	68,2	2,8	<b>SPBSA12</b>	 	<b>1292</b>
Dieses Produkt enthält eine Lichtquelle der Energieeffizienzklasse F						
 <p>LED-Aufbauleuchte für Spiegelpaneel mit LED-Mini-Stecker, 6000 K, 17,3 W, 2160 Lumen, EEK E <b>Helligkeit dimmbar</b></p> <p><i>LED-lighting for mirror panel with LED-mini-plug, 6000 K, 17,3 W, 2160 lumen, EEC E <b>brighness dimmable</b></i></p>	120,0	2,4	10,0	<b>AWP120</b>	 	<b>439</b>
Dieses Produkt enthält eine Lichtquelle der Energieeffizienzklasse E						



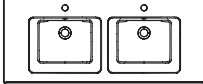

EEK/EEC=Energieeffizienzklasse/energy efficiency category

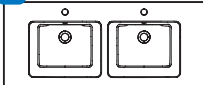



Leuchtmittel sind nicht austauschbar / illuminants are not interchangeable.

# 3290fair »120 cm D Keramik/ceramic«

Beschreibung Description	Maße in cm Dimensions in cm			Artikel-Nr. Article no.	Türanschlag Door stop	Identnummer ID number
	B/W	H	T/D			

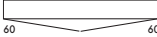
	Keramik-Doppel-Waschtisch inkl. Überlauf  <i>ceramic double washbasin incl. overflow</i>	121,0	1,5	51,0	<b>KWCHR12D</b> 	<b>2053</b>
	Keramik-Doppel-Waschtisch mit Dekor- kante, inkl. Überlauf  <i>ceramic double washbasin with decor edge, incl. overflow</i>	118,0	1,5	49,5	<b>KWCHD12D</b> 	<b>2976</b>

						PG1
	Waschtisch-Unterschrank für Doppelwaschtisch 1 Schubkasten  <i>washbasin base cabinet for double washbasin 1 drawer</i>	117,0	23,8	49,3	<b>GWKHS11D</b>	<b>1154</b>
	Waschtisch-Unterschrank für Doppelwaschtisch 1 feste Blende, 1 Schubkasten  <i>washbasin base cabinet for double washbasin 1 fixed cover, 1 drawer</i>	117,0	36,6	49,3	<b>GWKHBS11D</b>	<b>1246</b>
	Waschtisch-Unterschrank für Doppelwaschtisch 1 Schubkasten, 1 Auszug  <i>washbasin base cabinet for double washbasin 1 drawer, 1 extension</i>	117,0	47,8	49,3	<b>GWKHS A11D</b>	<b>1615</b>
	Waschtisch-Unterschrank für Doppelwaschtisch 1 feste Blende, 1 Schubkasten, 1 Auszug  <i>washbasin base cabinet for double washbasin 1 fixed cover, 1 drawer, 1 extension</i>	117,0	60,6	49,3	<b>GWKHBSA11D</b>	<b>1777</b>







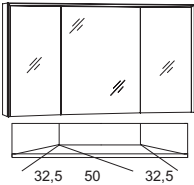

 	Spiegelschrank, 2 beidseitig verspiegelte Türen, 4 Glaseinlegeböden, inkl. Schalter/ Steckdose, seitliche LED-Beleuchtung, 6000 K, 2x 6,3 W, 2x 660 Lumen, EEK F  <i>mirror cabinet, 2 doors mirrored on both sides, 4 glass boards, incl. switch/socket lateral LED-lighting, 6000 K, 2x 6,3 W, 2x 660 lumen, EEC F</i>	120,0	68,2	17,6	<b>SADA12D</b>   Dieses Produkt enthält eine Lichtquelle der Energieeffizienzklasse F	<b>1961</b>
	LED-Aufbauleuchte für Spiegelschrank mit LED-Mini-Stecker, 6000 K, 16,8 W, 2106 Lumen, EEK E  <i>LED-lighting for mirror cabinet with LED-mini-plug, 6000 K, 16,8 W, 2106 lumen, EEC E</i>	120,0	2,4	20,0	<b>AW120</b>   Dieses Produkt enthält eine Lichtquelle der Energieeffizienzklasse E	<b>485</b>

EEK/EEC=Energieeffizienzklasse/energy efficiency category

Leuchtmittel sind nicht austauschbar / illuminants are not interchangeable.

 Dekorkantenfarben unbedingt mit angeben, Übersicht siehe Seite 2. Please indicate decor edge colours, overview see page 2.

# 3290fair »120 cm D Keramik/ceramic«





Beschreibung Description	Maße in cm Dimensions in cm			Artikel-Nr. Article no.	Türanschlag Door stop	Identnummer ID number
	B/W	H	T/D			
 <p>Spiegelschrank, 3 Spiegeltüren - davon 2 trapezförmig angeordnet, 6 Glaseinlegeböden, inkl. Schalter/Steckdose, <b>seitlich und oben LED-Beleuchtung</b>, 6000 K, 20,3 W, 960 Lumen, EEK E</p> <p><i>mirror cabinet, 3 mirror doors - 2 of them are arranged in a trapeze, 6 glass shelves, incl. switch/socket, <b>lateral and top LED lighting</b>, 6000 K, 20,3 W, 960 lumen, EEC E</i></p>	120,0	68,2	17,6	<b>SDU12</b>		<b>2492</b>
Dieses Produkt enthält eine Lichtquelle der Energieeffizienzklasse E						
 <p>Spiegelpaneel, Sensorschalter, seitliche LED-Beleuchtung 6000 K, 2x 6,3 W, <b>Helligkeit dimmbar</b></p> <p><i>mirror panel, sensor switch, lateral LED-lighting 6000 K, 2x 6,3 W, <b>brighness dimmable</b></i></p>	120,0	68,2	2,8	<b>SPBSA12</b>	 	<b>1292</b>
Dieses Produkt enthält eine Lichtquelle der Energieeffizienzklasse F						
 <p>LED-Aufbauleuchte für Spiegelpaneel mit LED-Mini-Stecker, 6000 K, 17,3 W, 2160 Lumen, EEK E <b>Helligkeit dimmbar</b></p> <p><i>LED-lighting for mirror panel with LED-mini-plug, 6000 K, 17,3 W, 2160 lumen, EEC E <b>brighness dimmable</b></i></p>	120,0	2,4	10,0	<b>AWP120</b>	 	<b>439</b>
Dieses Produkt enthält eine Lichtquelle der Energieeffizienzklasse E						

EEK/EEC=Energieeffizienzklasse/energy efficiency category

Leuchtmittel sind nicht austauschbar / illuminants are not interchangeable.



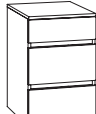
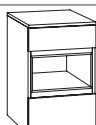

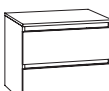
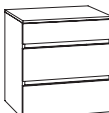
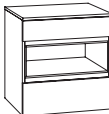



# 3290fair »Unterschränke mit Abdeckplatte/base cabinets with cover plaid«

Beschreibung Description	Maße in cm Dimensions in cm			Artikel-Nr. Article no.	Türanschlag Door stop	Identnummer ID number
	B/W	H	T/D			







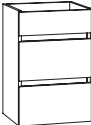

						PG1
	Unterschrank mit Abdeckplatte 1 Auszug  <i>base cabinet incl. top 1 extension</i>	40,0	25,6	49,3	<b>GUHA4F</b>	<b>785</b>
	Unterschrank mit Abdeckplatte 1 Schubkasten, 1 Auszug  <i>base cabinet incl. top 1 drawer, 1 extension</i>	40,0	38,4	49,3	<b>GUHSA4F</b>	<b>1038</b>
	Unterschrank mit Abdeckplatte 2 Auszüge  <i>base cabinet incl. top 2 extensions</i>	40,0	49,6	49,3	<b>GUHAA4F</b>	<b>1085</b>
	Unterschrank mit Abdeckplatte 1 Schubkasten, 2 Auszüge  <i>sideboard incl. top 1 drawer, 2 extensions</i>	40,0	62,4	49,3	<b>GUHSA4F</b>	<b>1407</b>
	<b>i</b> Unterschrank mit Abdeckplatte 1 Schubkasten, 1 Einschubregal, 1 Auszug  <i>sideboard incl. top 1 drawer, 1 push-in shelf, 1 extension</i>	40,0	62,4	49,3	<b>GUHSEA4F</b>	<b>1292</b>
	Unterschrank mit Abdeckplatte 1 Auszug  <i>base cabinet incl. top 1 extension</i>	60,0	25,6	49,3	<b>GUHA6F</b>	<b>830</b>
	Unterschrank mit Abdeckplatte 1 Schubkasten, 1 Auszug  <i>base cabinet incl. top 1 drawer, 1 extension</i>	60,0	38,4	49,3	<b>GUHSA6F</b>	<b>1200</b>
	Unterschrank mit Abdeckplatte 2 Auszüge  <i>base cabinet incl. top 2 extensions</i>	60,0	49,6	49,3	<b>GUHAA6F</b>	<b>1246</b>
	Unterschrank mit Abdeckplatte 1 Schubkasten, 2 Auszüge  <i>sideboard incl. top 1 drawer, 2 extensions</i>	60,0	62,4	49,3	<b>GUHSA6F</b>	<b>1522</b>
	<b>i</b> Unterschrank mit Abdeckplatte 1 Schubkasten, 1 Einschubregal, 1 Auszug  <i>sideboard incl. top 1 drawer, 1 push-in shelf, 1 extension</i>	60,0	62,4	49,3	<b>GUHSEA6F</b>	<b>1453</b>

**i** Regalfarben unbedingt mit angeben, Übersicht siehe Seite 4. Please indicate shelf colours, overview see page 4.

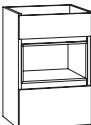
# 3290fair »Unterschränke mit Abdeckplatte/base cabinets with cover plaid«



Beschreibung Description	Maße in cm Dimensions in cm			Artikel-Nr. Article no.	Türanschlag Door stop	Identnummer ID number
	B/W	H	T/D			
						PG1
 <p>Unterschrank mit Abdeckplatte 1 Auszug <i>base cabinet incl. top 1 extension</i></p>	97,0	25,6	49,3	<b>GUHA9F</b>		<b>1061</b>
 <p>Unterschrank mit Abdeckplatte 1 Schubkasten, 1 Auszug <i>base cabinet incl. top 1 drawer, 1 extension</i></p>	97,0	38,4	49,3	<b>GUHSA9F</b>		<b>1500</b>
 <p>Unterschrank mit Abdeckplatte 2 Auszüge <i>base cabinet incl. top 2 extensions</i></p>	97,0	49,6	49,3	<b>GUHAA9F</b>		<b>1546</b>
 <p>Unterschrank mit Abdeckplatte 1 Schubkasten, 2 Auszüge <i>sideboard incl. top 1 drawer, 2 extensions</i></p>	97,0	62,4	49,3	<b>GUHSA9F</b>		<b>1915</b>
 <p>Unterschrank mit Abdeckplatte 1 Auszug <i>base cabinet incl. top 1 extension</i></p>	117,0	25,6	49,3	<b>GUHA11F</b>		<b>1107</b>
 <p>Unterschrank mit Abdeckplatte 1 Schubkasten, 1 Auszug <i>base cabinet incl. top 1 drawer, 1 extension</i></p>	117,0	38,4	49,3	<b>GUHSA11F</b>		<b>1638</b>
 <p>Unterschrank mit Abdeckplatte 2 Auszüge <i>base cabinet incl. top 2 extensions</i></p>	117,0	49,6	49,3	<b>GUHAA11F</b>		<b>1684</b>
 <p>Sideboard mit Abdeckplatte 1 Schubkasten, 2 Auszüge <i>sideboard incl. top 1 drawer, 2 extensions</i></p>	117,0	62,4	49,3	<b>GUHSA11F</b>		<b>2123</b>

# 3290fair »Unterschränke (Sideboards) ohne Abdeckplatte/base cabinets (sideboards) without cover plaid«



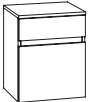
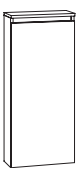

Beschreibung Description	Maße in cm Dimensions in cm			Artikel-Nr. Article no.	Türanschlag Door stop	Identnummer ID number
	B/W	H	T/D			
PG1						
 <p>Unterschrank ohne Abdeckplatte 1 Schubkasten, 2 Auszüge <i>base cabinet without top 1 drawer, 2 extensions</i></p>	40,0	60,6	35,0	<b>GUHSAA4</b>		<b>1246</b>
  <p>Unterschrank ohne Abdeckplatte 1 Schubkasten, 1 Einschubregal, 1 Auszug <i>base cabinet without top 1 drawer, 1 push-in shelf, 1 extension</i></p>	40,0	60,6	35,0	<b>GUHSEA4</b>		<b>1154</b>
 <p>Unterschrank ohne Abdeckplatte 1 Schubkasten, 2 Auszüge <i>base cabinet without top 1 drawer, 2 extensions</i></p>	60,0	60,6	35,0	<b>GUHSAA6</b>		<b>1384</b>
  <p>Unterschrank ohne Abdeckplatte 1 Schubkasten, 1 Einschubregal, 1 Auszug <i>base cabinet without top 1 drawer, 1 push-in shelf, 1 extension</i></p>	60,0	60,6	35,0	<b>GUHSEA6</b>		<b>1292</b>
 <p>Unterschrank ohne Abdeckplatte 1 Schubkasten, 2 Auszüge <i>base cabinet without top 1 drawer, 2 extensions</i></p>	97,0	60,6	35,0	<b>GUHSAA9</b>		<b>1661</b>
 <p>Unterschrank ohne Abdeckplatte 1 Schubkasten, 2 Auszüge <i>base cabinet without top 1 drawer, 2 extensions</i></p>	117,0	60,6	35,0	<b>GUHSAA11</b>		<b>1868</b>
PG1						
 <p>Maßvariable Abdeckplatte für Unterschränke ohne Abdeckplatte <i>cover panel in variable dimensions for base cabinets without top</i></p>	200,0 max.	1,6	49,3 max.	<b>ADFV</b>		<b>221</b>
Dickkante/thick edge						

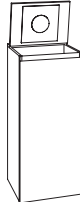
 Regalfarben unbedingt mit angeben, Übersicht siehe Seite 4. Please indicate shelf colours, overview see page 4.

# 3290fair »Beistellschränke/ side cabinets«

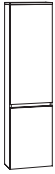
Beschreibung Description	Maße in cm Dimensions in cm			Artikel-Nr. Article no.	Türanschlag Door stop	Identnummer ID number	
	B/W	H	T/D				
	Oberschrank 1 Tür 2 Glaseinlegeböden  <i>top cabinet 1 door 2 glass boards</i>	40,0	68,2	17,6	<b>GOT40DL</b> <b>GOT40DR</b>	Links/ <i>left</i> Rechts/ <i>right</i>	PG1 <b>485</b>
	Unterschrank inkl. Abdeckplatte 1 Tür, 1 Schubkasten  <i>base cabinet incl. top 1 door, 1 drawer</i>	40,0	49,6	35,0	<b>GUST4FL</b> <b>GUST4FR</b>	Links/ <i>left</i> Rechts/ <i>right</i>	<b>830</b>
	Highboard inkl. Abdeckplatte 1 Tür 2 Glaseinlegeböden  <i>high cabinet incl. top 1 door 2 glass boards</i>	40,0	91,2	17,6	<b>GHBFT4FL</b> <b>GHBFT4FR</b>	Links/ <i>left</i> Rechts/ <i>right</i>	<b>692</b>
	Highboard inkl. Abdeckplatte 1 Tür, 1 Schubkasten 2 Glaseinlegeböden  <i>high cabinet incl. top 1 door, 1 drawer 2 glass boards</i>	40,0	91,2	35,0	<b>GHBST4FL</b> <b>GHBST4FR</b>	Links/ <i>left</i> Rechts/ <i>right</i>	<b>739</b> <b>992</b>
	Highboard inkl. Abdeckplatte 1 Tür/Wäschekippe  <i>high cabinet incl. top 1 door/linen bin</i>	40,0	91,2	35,0	<b>GHBW4F</b>		<b>785</b>
	Schminkschrank inkl. Deckel 1 Tür, 1 Klappe 2 Glaseinlegeböden Kosmetikeinsatz & Vergrößerungsspiegel  <i>make-up cabinet incl. lid 1 door, 1 flap door 2 glass boards cosmetic insert part &amp; magnifying mirror</i>	40,0	91,2	35,0	<b>GHBKT4L</b> <b>GHBKT4R</b>	Links/ <i>left</i> Rechts/ <i>right</i>	<b>1384</b>

# 3290fair »Beistellschränke/ side cabinets«







Beschreibung Description	Maße in cm Dimensions in cm			Artikel-Nr. Article no.	Türanschlag Door stop	Identnummer ID number
	B/W	H	T/D			
PG1						
 <p>Mittelschrank inkl. Abdeckplatte 2 Türen 3 Glaseinlegeböden</p> <p><i>medium cabinet incl. top 2 doors 3 glass boards</i></p>	40,0	148,8	35,0	<b>GMTT4FL</b> <b>GMTT4FR</b>	Links/left Rechts/right	<b>1107</b>
 <p>Mittelschrank inkl. Abdeckplatte 2 Türen, 1 Einschubregal 2 Glaseinlegeböden</p> <p><i>medium cabinet incl. top 2 doors, 1 push-in shelf 2 glass boards</i></p>	40,0	148,8	35,0	<b>GMTET4FL</b> <b>GMTET4FR</b>	Links/left Rechts/right	<b>1338</b>
 <p>Mittelschrank inkl. Abdeckplatte 2 Türen, 1 Schubkasten 3 Glaseinlegeböden</p> <p><i>medium cabinet incl. top 2 doors, 1 drawer 3 glass boards</i></p>	40,0	148,8	35,0	<b>GMTST4FL</b> <b>GMTST4FR</b>	Links/left Rechts/right	<b>1362</b>
 <p>Mittelschrank inkl. Abdeckplatte 1 Tür, 2 Auszüge 2 Glaseinlegeböden</p> <p><i>medium cabinet incl. top 1 door, 2 extensions 2 glass boards</i></p>	40,0	148,8	35,0	<b>GMTAA4FL</b> <b>GMTAA4FR</b>	Links/left Rechts/right	<b>1546</b>
 <p>Glasregal mit Holzrückwand in Korpus- farbe, inkl. Abdeckplatte 7 Glasböden</p> <p><i>glass shelf with wooden back panel in carcase colour, incl. top 7 glass boards</i></p>	33,8	148,8	15,0	<b>MGR33F</b>		<b>2583</b>  <b>Bitte Korpusfarbe angeben</b> <b>Please indicate shelf colour</b>

**i** Regalfarben unbedingt mit angeben, Übersicht siehe Seite 4. *Please indicate shelf colours, overview see page 4*









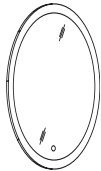

# 3290fair »Beistellschränke/ side cabinets«

Beschreibung Description	Maße in cm Dimensions in cm			Artikel-Nr. Article no.	Türanschlag Door stop	Identnummer ID number
	B/W	H	T/D			

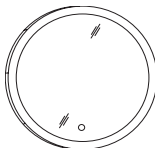
							PG1
	Hochschrank 2 Türen 4 Glaseinlegeböden	40,0	178,7	17,6	<b>GHFTT4L</b> <b>GHFTT4R</b>	Links/ <i>left</i> Rechts/ <i>right</i>	<b>1061</b>
	<i>tower cabinet</i> <i>2 doors</i> <i>4 glass boards</i>	40,0	178,7	35,0	<b>GHTT4L</b> <b>GHTT4R</b>	Links/ <i>left</i> Rechts/ <i>right</i>	<b>1246</b>
 	Hochschrank 2 Türen, 1 Einschubregal 4 Glaseinlegeböden	40,0	178,7	35,0	<b>GHTET4L</b> <b>GHTET4R</b>	Links/ <i>left</i> Rechts/ <i>right</i>	<b>1522</b>
<i>tower cabinet</i> <i>2 doors, 1 push-in shelf</i> <i>4 glass boards</i>							
	Hochschrank 2 Türen, 1 Schubkasten 3 Glaseinlegeböden	40,0	178,7	35,0	<b>GHTST4L</b> <b>GHTST4R</b>	Links/ <i>left</i> Rechts/ <i>right</i>	<b>1546</b>
<i>tower cabinet</i> <i>2 doors, 1 drawer</i> <i>3 glass boards</i>							
	Hochschrank 1 Tür, 1 Tür/Wäschekippe 2 Glaseinlegeböden	40,0	178,7	35,0	<b>GHTW4L</b> <b>GHTW4R</b>	Links/ <i>left</i> Rechts/ <i>right</i>	<b>1292</b>
<i>tower cabinet</i> <i>1 door, 1 door/linen bin</i> <i>2 glass boards</i>							
	Hochschrank 1 Tür, 3 Auszüge 2 Glaseinlegeböden	40,0	178,7	35,0	<b>GHTAAA4L</b> <b>GHTAAA4R</b>	Links/ <i>left</i> Rechts/ <i>right</i>	<b>1915</b>
<i>tower cabinet</i> <i>1 door, 3 extensions</i> <i>2 glass boards</i>							
	Glasregal mit Holzrückwand in Korpusfarbe 7 Glasböden	33,8	178,7	15,0	<b>HGR33</b>		<b>2953</b>
<i>glass shelf with wooden back panel in carcase colour</i> <i>7 glass boards</i>						<b>Bitte Korpusfarbe angeben</b> <b>Please indicate shelf colour</b>	

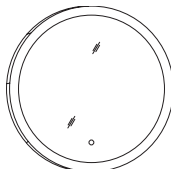
 Regalfarben unbedingt mit angeben, Übersicht siehe Seite 4. Please indicate shelf colours, overview see page 4

# 3290fair »Spiegelpaneele und Zubehör/mirror panels and accessoires«

Beschreibung Description	Maße in cm Dimensions in cm			Artikel-Nr. Article no.	Türanschlag Door stop	Identnummer ID number
	B/W	H	T/D			
 <p>Spiegelpaneel, Sensorschalter, satiniert, LED Beleuchtung, 4000 K, 17,3 W, 2415 Lumen, EEK G <b>Helligkeit dimmbar</b></p> <p><i>mirror panel, sensor switch, satined, LED-lighting, 4000 K, 17,3 W, 2415 lumen, EEC G</i> <b>brighness dimmable</b></p>	55,0	78,0	2,8	<b>SPE55</b>   Dieses Produkt enthält eine Lichtquelle der Energieeffizienzklasse G	1131	
 <p>Spiegelpaneel, Sensorschalter, satiniert, LED Beleuchtung, 4000 K, 13,5 W, 1890 Lumen, EEK G <b>Helligkeit dimmbar</b></p> <p><i>mirror panel, sensor switch, satined, LED-lighting, 4000 K, 13,5 W, 1890 lumen, EEC G</i> <b>brighness dimmable</b></p>	55,0	55,0	2,8	<b>SPK55</b>   Dieses Produkt enthält eine Lichtquelle der Energieeffizienzklasse G	992	
 <p>Spiegelpaneel, Sensorschalter, satiniert, LED Beleuchtung, 4000 K, 20,8 W, 2905 Lumen, EEK G <b>Helligkeit dimmbar</b></p> <p><i>mirror panel, sensor switch, satined, LED-lighting, 4000 K, 20,8 W, 2905 lumen, EEC G</i> <b>brighness dimmable</b></p>	78,0	78,0	2,8	<b>SPK78</b>   Dieses Produkt enthält eine Lichtquelle der Energieeffizienzklasse G	1292	
 <p>Steckdose/Powerbox für Spiegelschränke Ausführung <b>Schweiz</b> IP44 mit USB-C Stecker</p> <p><i>Power socket for mirror cabinets Switzerland type IP44 with USB-C plug</i></p>				<b>Mehrpreis extra charge</b>	138	
 <p>Steckdose/Powerbox für Spiegelschränke Ausführung <b>Frankreich</b> mit USB-C Stecker</p> <p><i>Power socket for mirror cabinets France type with USB-C plug</i></p>				<b>Mehrpreis extra charge</b>	138	

EEK/EEC=Energieeffizienzklasse/energy efficiency category  
Leuchtmittel sind nicht austauschbar / illuminants are not interchangeable.

**i** Weiteres Zubehör finden Sie im Register 3970.  
Further accessoires can be found in register 3970.



# 3350idea





# »3350idea«

## Piktogramme/pictograms



Mineralmarmor Waschtisch  
Marble minerals washbasin



LED Lichtfarbe kalt  
LED colour temperature cold



LED Lichtfarbe schaltbar bzw. regelbar  
LED colour temperature adjustable



Keramik Waschtisch  
Ceramic washbasin



LED Lichtfarbe regelbar,  
Helligkeit dimmbar  
LED colour temperature adjust-  
able, brightness dimmable

## Mineralmarmor Waschtisch weiß alpin Glanz Marble minerals washbasin gloss alpine white

≈ Beckenmaße in cm (BxHxD)  
basin dimensions in cm (WxHxD)

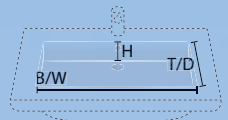

MWIDE8 | 68 x 12 x 30 cm



MWIDE10 | 68 x 12 x 30 cm



Detail



MWIDE12D | 56 x 12 x 30 cm

### Mineralmarmor Glanz/gloss marble minerals

PG1



**Weiß Alpin Glanz**  
Gloss Alpine White  
HC69

Bei granitfarbigen Waschtischen kann es zu Farbabweichungen kommen, da der Gelcoat die Farbgebung maßgeblich beeinflusst und sich im Laufe der Zeit die Farbe durch Lichteinflüsse (Sonneneinstrahlung) verändern kann.  
Colour deviations may occur with granite-coloured washbasins and the colour may change over time due to the influence of direct sunlight.

### Mineralmarmor Granit/granite marble minerals

PG2



**Granit Weiß Glimmer**  
White Granite Glimmer  
HC74

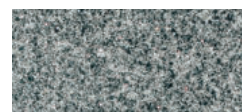

**Granit Grau glimmer**  
grey granite glimmer  
HC73

## Keramik Waschtisch weiß alpin Glanz (HCK) Ceramic washbasin gloss alpine white (HCK)



KWIDE8



KWIDE10

Alle Becken/all basins =  58 x 11,5 x 31 cm

 ≈ Beckenmaße in cm (BxHxT)  
basin dimensions in cm (WxHxD)

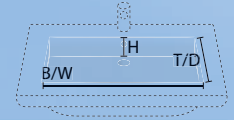

**!** Immer im Lieferumfang der Keramikwaschtische enthalten: Befestigungsmaterial MONK-4  
Always included in the scope of delivery of the ceramic washbasins: mounting material MONK-4

Wir empfehlen eine Montage nur durch einen qualifizierten Monteur/Installateur. Keine Haftung bei unsachgemäßer Montage.

MONK-4: 2 Stockschrauben M10x120 inkl. Dübel für massive Steinwand. Bei anderen Wandbeschaffenheiten müssen im Fachhandel entsprechende Dübel erworben werden.

We recommend installation only by a qualified fitter / installer. No liability for improper installation.

MONK-4: 2 screws M10x120 including dowels for a solid stone wall. For other wall conditions, suitable dowels must be purchased from a specialised dealer.

## Schränke/cabinets

### Frontfarben/front colours

#### Dickkante/thick edge

286



**Weiß Seidenglanz**  
*Silk Gloss White*  
HCE\_

284



**Anthrazit Seidenglanz**  
*Silk Gloss Anthracite*  
HCA\_

473



**Eiche Struktur Natur Nachbildung**  
*Oak Structure Nature Finish*  
HCM\_

#### MDF-Lack-foliert/MDF-lacquer-coated

477



**Weiß Lack Glanz**  
*Gloss Lacquer White*  
HCL\_

479

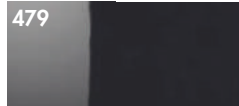

**Anthrazit Lack Glanz**  
*Gloss Lacquer Anthracite*  
HCO\_

### Korpusfarben/basic shell colours

#### PG 1 Dickkante/thick edge

286



**Weiß Seidenglanz**  
*Silk Gloss White*  
E/HC86

284



**Anthrazit Seidenglanz**  
*Silk Gloss Anthracite*  
A/HC84

473



**Eiche Struktur Natur Nachbildung**  
*Oak Structure Nature Finish*  
M/HC55

#### PG 3 MDF-Lack-foliert/MDF-lacquer-coated

477



**Weiß Lack Glanz**  
*Gloss Lacquer White*  
I/HC77

479

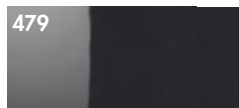

**Anthrazit Lack Glanz**  
*Gloss Lacquer Anthracite*  
O/HC79

## Griffleiste/handle bar



**Aluminium matt**  
Matt Aluminium

## Beleuchtung / lighting



**Aufbauleuchte LED**  
Top light LED



**Aufbauleuchte LED**  
Top light LED

**Lichtfarbe Tageslicht (Kalt)**  
Luminous colour natural light (cold)



LL74, LL94



FLS60, FLS90

**Lichtfarbe Wohlfühllicht (Warm)**  
Luminous colour warm light











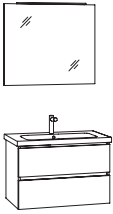

FLS60, FLS90

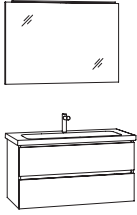
**Die Steckdose / Powerbox für Spiegelschränke ist auch in Ausführung für die Schweiz / Frankreich erhältlich. Bitte Mehrpreis beachten (siehe Seite 12).**  
The power socket for mirror cabinets is also available for Switzerland / France. Please note extra charge (see page 12).

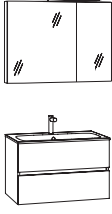

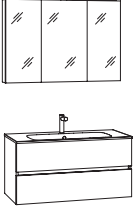

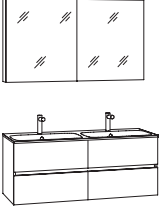



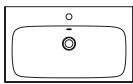

# 3350idea »Beispiel-Kombinationen/example-combinations«

Beschreibung Description	Maße in cm Dimensions in cm			Artikel-Nr. Article no.	Türanschlag Door stop	Identnummer ID number	
	B/W	H	T/D				

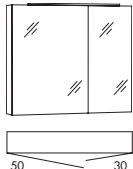
						PG1	PG3
	<p>Kombination 80 cm bestehend aus: Spiegelpaneel, Aufbauleuchte Keramik Waschtisch Waschtischunterschrank mit 2 Auszügen</p> <p><i>combination 80 cm width consisting of: mirror panel, top LED-lighting ceramics washbasin wash basin cabinet with 2 extensions</i></p>	<p><b>SPFLB8</b> <b>KWIDE8</b> <b>CWKGAA8</b></p>	  			1684	1684
						739	739
						1154	1476
						<hr/>	<hr/>
						3577	3899
	<p>Kombination 100 cm bestehend aus: Spiegelpaneel, Aufbauleuchte Keramik Waschtisch Waschtischunterschrank mit 2 Auszügen</p> <p><i>combination 100 cm width consisting of: mirror panel, top LED-lighting mineral marble washbasin wash basin cabinet with 2 extensions</i></p>	<p><b>SPFLB10</b> <b>KWIDE10</b> <b>CWKGAA10</b></p>	  			1753	1753
						877	877
						1338	1730
						<hr/>	<hr/>
						3968	4360
	<p>Kombination 80 cm bestehend aus: Spiegelschrank mit LED Aufbauleuchte Mineralmarmor Waschtisch Weiß Alpin Glanz Waschtischunterschrank mit 2 Auszügen</p> <p><i>combination 80 cm width consisting of: mirror cabinet with LED-lighting mineral marble washbasin gloss white alpine wash basin cabinet with 2 extensions</i></p>	<p><b>SFLB8L</b> <b>MWIDE8</b> <b>CWMGAA8</b></p>	  			2215	2215
						1114	1114
						1154	1476
						<hr/>	<hr/>
						4483	4805
	<p>Kombination 100 cm bestehend aus: Spiegelschrank mit LED Aufbauleuchte Mineralmarmor Waschtisch Weiß Alpin Glanz Waschtischunterschrank mit 2 Auszügen</p> <p><i>combination 100 cm width consisting of: mirror cabinet with LED-lighting mineral marble washbasin gloss white alpine wash basin cabinet with 2 extensions</i></p>	<p><b>SFLB10</b> <b>MWIDE10</b> <b>CWMGAA10</b></p>	  			2583	2583
						1277	1277
						1362	1730
						<hr/>	<hr/>
						5222	5590
	<p>Kombination 120 cm bestehend aus: Spiegelschrank mit LED Aufbauleuchte Mineralmarmor Waschtisch Weiß Alpin Glanz Waschtischunterschrank mit 4 Auszügen</p> <p><i>combination 120 cm width consisting of: mirror cabinet with LED-lighting mineral marble washbasin gloss white alpine wash basin cabinet with 4 extensions</i></p>	<p><b>SFLB12</b> <b>MWIDE12D</b> <b>CWMGAA12</b></p>	  			2630	2630
						1661	1661
						1892	2353
						<hr/>	<hr/>
						6183	6644

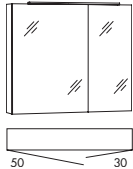
Handtuchhalter, Regale, Unterbauleuchtungen und weiteres Zubehör finden Sie in der Rubrik 3970zubehör.  
Towel rails, shelves, base lightings and other accessories can be found in the 3970accessories range.

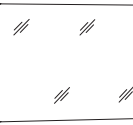

# 3350idea »80 cm Mineralmarmor/marble minerals«

Beschreibung Description	Maße in cm Dimensions in cm			Artikel-Nr. Article no.	Türanschlag Door stop	Identnummer ID number	
	B/W	H	T/D			PG1 Weiß alpin/gloss alpine	PG2 Granit/granite
 <p>Mineralmarmor-Waschtisch inkl. Überlauf</p> <p><i>marble minerals washbasin incl. overflow</i></p>	76,5	1,5	45,0	<b>MWIDE8</b>		<b>1114</b>	<b>1394</b>
 <p>Waschtisch-Unterschrank 2 Auszüge</p> <p><i>washbasin base cabinet 2 extensions</i></p>	76,0	49,5	44,5	<b>CWMGAA8</b>		<b>1154</b>	<b>1476</b>
<p><b>Aufbauleuchte/top light</b></p>  <p>Spiegelschrank, 2 beidseitig verspiegelte Türen, 2 Glaseinlegeböden, inkl. Schalter/Steckdose, <b>LED Aufbauleuchte FLS60</b> 2800-6500 K, 12 W, 926 Lumen, EEK G <b>Helligkeit dimmbar</b></p> <p><i>mirror cabinet, 2 doors mirrored on both sides, 2 glass boards, incl. switch/socket <b>LED lighting FLS60, 2800-6500 K, 12 W, 926 lumen, EEC G brightness dimmable</b></i></p>	80,0	68,2	13,6	<b>SFLB8L</b>		<b>2215</b>	
				<b>SFLB8R</b>	Dieses Produkt enthält eine Lichtquelle der Energieeffizienzklasse G		
<p><b>Aufbauleuchte/top light</b></p>  <p>Spiegelschrank, 2 beidseitig verspiegelte Türen, 2 Glaseinlegeböden, inkl. Schalter/Steckdose, <b>LED Aufbauleuchte LL74</b> 6000 K, 6,0 W, 720 Lumen, EEK E</p> <p><i>mirror cabinet, 2 doors mirrored on both sides, 2 glass boards, incl. switch/socket <b>LED lighting LL74, 6000 K, 6,0 W, 720 lumen, EEC E</b></i></p>	80,0	68,2	13,6	<b>SLLD8L</b>		<b>1638</b>	
				<b>SLLD8R</b>	Dieses Produkt enthält eine Lichtquelle der Energieeffizienzklasse E		
<p><b>Aufbauleuchte/top light</b></p>  <p>Spiegelpaneel, inkl. Schalter Mitte unten, <b>LED Aufbauleuchte FLS60, umschaltbar in 2 Lichtfarben, 4000/6000 K, 12 W, 926 Lumen, EEK G</b></p> <p><i>mirror panel, incl. switch center below, <b>LED lighting FLS60, two switchable luminous colours, 4000/6000 K, 12 W, 926 lumen, EEC G</b></i></p>	80,0	68,2	2,8	<b>SPFLB8</b>		<b>1684</b>	
				<b>SPOO8</b>	Dieses Produkt enthält eine Lichtquelle der Energieeffizienzklasse G		
 <p>Spiegelpaneel ohne Beleuchtung</p> <p><i>mirror panel without lighting</i></p>	80,0	68,2	2,8	<b>SPOO8</b>		<b>415</b>	



EEK/EEC=Energieeffizienzklasse/energy efficiency category  
Leuchtmittel sind nicht austauschbar / illuminants are not interchangeable.

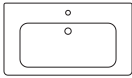

# 3350idea »80 cm Keramik/ceramic«

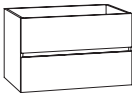

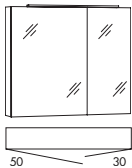
Beschreibung Description	Maße in cm Dimensions in cm			Artikel-Nr. Article no.	Türanschlag Door stop	Identnummer ID number
	B/W	H	T/D			

 <p>Keramik-Waschtisch inkl. Überlauf und Befestigungsmaterial</p> <p><i>ceramics washbasin incl. overflow and mounting material</i></p>	80,0	3,0	45,5	<b>KWIDE8</b> 	<b>739</b>	

 <p>Waschtisch-Unterschrank 2 Auszüge</p> <p><i>washbasin base cabinet 2 extensions</i></p>	76,0	49,5	44,5	<b>CWKGAA8</b>	<b>1154</b>	<b>1476</b>
					PG1	PG3







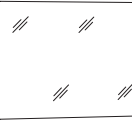

<p><b>Aufbauleuchte/top light</b></p>  <p>Spiegelschrank, 2 beidseitig verspiegelte Türen, 2 Glaseinlegeböden, inkl. Schalter/Steckdose, <b>LED Aufbauleuchte FLS60 2800-6500 K</b>, 12 W, 926 Lumen, EEK G <b>Helligkeit dimmbar</b></p>	80,0	68,2	13,6	<b>SFLB8L</b> 	<b>2215</b>	

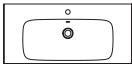
<p><b>Aufbauleuchte/top light</b></p>  <p>Spiegelschrank, 2 beidseitig verspiegelte Türen, 2 Glaseinlegeböden, inkl. Schalter/Steckdose, <b>LED Aufbauleuchte LL74 6000 K</b>, 6,0 W, 720 Lumen, EEK E</p>	80,0	68,2	13,6	<b>SLLD8L</b> 	<b>1638</b>	

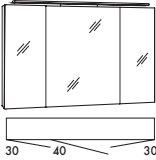
<p><b>Aufbauleuchte/top light</b></p>  <p>Spiegelpaneel, inkl. Schalter Mitte unten, <b>LED Aufbauleuchte FLS60, umschaltbar in 2 Lichtfarben</b>, 4000/6000 K, 12 W, 926 Lumen, EEK G</p>	80,0	68,2	2,8	<b>SPFLB8</b> 	<b>1684</b>	

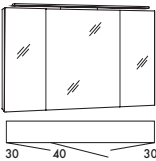
 <p>Spiegelpaneel ohne Beleuchtung</p> <p><i>mirror panel without lighting</i></p>	80,0	68,2	2,8	<b>SPOO8</b>	<b>415</b>	

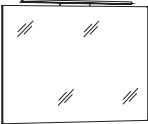

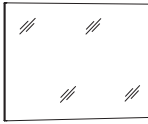
EEK/EEC=Energieeffizienzklasse/energy efficiency category  
Leuchtmittel sind nicht austauschbar / illuminants are not interchangeable.

Beschreibung <i>Description</i>	Maße in cm <i>Dimensions in cm</i>			Artikel-Nr. <i>Article no.</i>	Türanschlag <i>Door stop</i>	Identnummer <i>ID number</i>	
	B/W	H	T/D			PG1	PG2
 <p>Mineralmarmor-Waschtisch inkl. Überlauf</p> <p><i>marble minerals washbasin incl. overflow</i></p>	96,5	1,5	45,0	<b>MWIDE10</b>		PG1 Weiß alpin/ <i>gloss alpine</i>	PG2 Granit/ <i>granite</i>
						<b>1277</b>	<b>1598</b>
 <p>Waschtisch-Unterschrank 2 Auszüge</p> <p><i>washbasin base cabinet 2 extensions</i></p>	96,0	49,5	44,5	<b>CWMGAA10</b>		PG1	PG3
						<b>1362</b>	<b>1730</b>
<p><b>Aufbauleuchte/top light</b></p>  <p>Spiegelschrank, 3 beidseitig verspiegelte Türen, 4 Glaseinlegeböden, inkl. Schalter/Steckdose, <b>LED Aufbauleuchte FLS90 2800-6500 K</b>, 17,5 W, 1390 Lumen, EEK G <b>Helligkeit dimmbar</b></p> <p><i>mirror cabinet, 3 doors mirrored on both sides, 4 glass boards, incl. switch/socket LED lighting FLS90, 2800-6500 K, 17,5 W, 1390 lumen, EEC G brightness dimmable</i></p>	100,0	68,2	13,6	<b>SFLB10</b>			<b>2583</b>
					Dieses Produkt enthält eine Lichtquelle der Energieeffizienzklasse G		
<p><b>Aufbauleuchte/top light</b></p>  <p>Spiegelschrank, 3 beidseitig verspiegelte Türen, 4 Glaseinlegeböden, inkl. Schalter/Steckdose, <b>LED-Aufbauleuchte LL94</b>, 6000 K, 7,4 W, 892 Lumen, EEK E</p> <p><i>mirror cabinet, 3 doors mirrored on both sides, 4 glass boards, incl. switch/socket LED lighting LL94, 6000 K, 7,4 W, 892 lumen, EEC E</i></p>	100,0	68,2	13,6	<b>SLLD10</b>			<b>1961</b>
					Dieses Produkt enthält eine Lichtquelle der Energieeffizienzklasse E		
<p><b>Aufbauleuchte/top light</b></p>  <p>Spiegelpaneel, inkl. Schalter Mitte unten, <b>LED Aufbauleuchte FLS90, umschaltbar in 2 Lichtfarben</b>, 4000/6000 K, 17,5 W, 1390 Lumen, EEK G</p> <p><i>mirror panel, incl. switch center below, LED lighting FLS90, two switchable luminous colours, 4000/6000 K, 17,5 W, 1390 lumen, EEC G</i></p>	100,0	68,2	2,8	<b>SPFLB10</b>			<b>1753</b>
					Dieses Produkt enthält eine Lichtquelle der Energieeffizienzklasse G		
 <p>Spiegelpaneel ohne Beleuchtung</p> <p><i>mirror panel without lighting</i></p>	100,0	68,2	2,8	<b>SPOO10</b>			<b>439</b>



EEK/EEC=Energieeffizienzklasse/energy efficiency category  
Leuchtmittel sind nicht austauschbar / illuminants are not interchangeable.

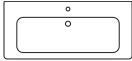

# 3350idea »100 cm Keramik/ceramic«

Beschreibung Description	Maße in cm Dimensions in cm			Artikel-Nr. Article no.	Türanschlag Door stop	Identnummer ID number
	B/W	H	T/D			

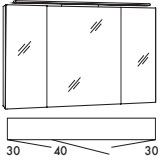
 <p>Keramik-Waschtisch inkl. Überlauf und Befestigungsmaterial</p> <p><i>ceramics washbasin incl. overflow and mounting material</i></p>	100,0	3,0	45,5	KWIDE10		877
						PG1

 <p>Waschtisch-Unterschrank 2 Auszüge</p> <p><i>washbasin base cabinet 2 extensions</i></p>	96,0	49,5	44,5	CWKGAA10	1338	1730
					PG1	PG3

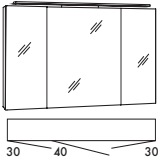



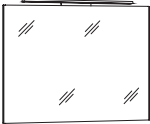

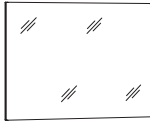

<p>Aufbauleuchte/top light</p>  <p>Spiegelschrank, 3 beidseitig verspiegelte Türen, 4 Glaseinlegeböden, inkl. Schalter/Steckdose, <b>LED Aufbauleuchte FLS90 2800-6500 K</b>, 17,5 W, 1390 Lumen, EEK G <b>Helligkeit dimmbar</b></p> <p><i>mirror cabinet, 3 doors mirrored on both sides, 4 glass boards, incl. switch/socket <b>LED lighting FLS90, 2800-6500 K, 17,5 W, 1390 lumen, EEC G brightness dimmable</b></i></p>	100,0	68,2	13,6	SFLB10		2583
						Dieses Produkt enthält eine Lichtquelle der Energieeffizienzklasse G

<p>Aufbauleuchte/top light</p>  <p>Spiegelschrank, 3 beidseitig verspiegelte Türen, 4 Glaseinlegeböden, inkl. Schalter/Steckdose, <b>LED-Aufbauleuchte LL94</b>, 6000 K, 7,4 W, 892 Lumen, EEK E</p> <p><i>mirror cabinet, 3 doors mirrored on both sides, 4 glass boards, incl. switch/socket <b>LED lighting LL94, 6000 K, 7,4 W 892 lumen, EEC E</b></i></p>	100,0	68,2	13,6	SLLD10		1961
						Dieses Produkt enthält eine Lichtquelle der Energieeffizienzklasse E

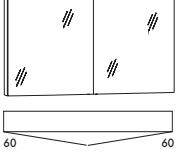
<p>Aufbauleuchte/top light</p>  <p>Spiegelpaneel, inkl. Schalter Mitte unten, <b>LED Aufbauleuchte FLS90, umschaltbar in 2 Lichtfarben, 4000/6000 K</b>, 17,5 W, 1390 Lumen, EEK G</p> <p><i>mirror panel, incl. switch center below, <b>LED lighting FLS90, two switchable luminous colours, 4000/6000 K, 17,5 W, 1390 lumen, EEC G</b></i></p>	100,0	68,2	2,8	SPFLB10		1753
						Dieses Produkt enthält eine Lichtquelle der Energieeffizienzklasse G

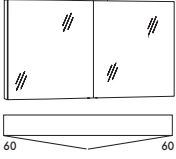

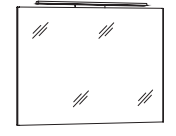

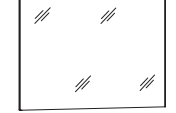
 <p>Spiegelpaneel ohne Beleuchtung</p> <p><i>mirror panel without lighting</i></p>	100,0	68,2	2,8	SPOO10	439

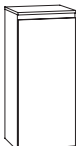
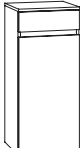
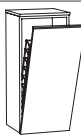
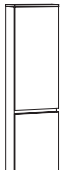

EEK/EEC=Energieeffizienzklasse/energy efficiency category  
Leuchtmittel sind nicht austauschbar / illuminants are not interchangeable.

Beschreibung <i>Description</i>	Maße in cm <i>Dimensions in cm</i>			Artikel-Nr. <i>Article no.</i>	Türanschlag <i>Door stop</i>	Identnummer <i>ID number</i>	
	B/W	H	T/D			PG1 <i>Weiß alpin/gloss alpine</i>	PG2 <i>Granit/granite</i>
 <p>Mineralmarmor-Doppelwaschtisch inkl. Überlauf <i>marble minerals double washbasin incl. overflow</i></p>	120,5	1,5	45,0	<b>MWIDE12D</b> 		<b>1661</b>	<b>2123</b>
 <p>Waschtisch-Unterschrank 4 Auszüge <i>washbasin base cabinet 4 extensions</i></p>	120,0	49,5	44,5	<b>CWMGAA12</b>		<b>1892</b>	<b>2353</b>
<p><b>Aufbauleuchte/top light</b></p>  <p>Spiegelschrank, 2 beidseitig verspiegelte Türen, 4 Glaseinlegeböden, inkl. Schalter/ Steckdose, <b>LED Aufbauleuchte FLS90</b> <b>2800-6500 K</b>, 17,5 W, 1390 Lumen, EEK G <b>Helligkeit dimmbar</b> <i>mirror cabinet, 2 doors mirrored on both sides, 4 glass boards, incl. switch/socket LED lighting FLS90, 2800-6500 K, 17,5 W, 1390 lumen, EEC G brightness dimmable</i></p>	120,0	68,2	13,6	<b>SFLB12</b> 			<b>2630</b>
<p><b>Aufbauleuchte/top light</b></p>  <p>Spiegelschrank, 2 beidseitig verspiegelte Türen, 4 Glaseinlegeböden, inkl. Schalter/ Steckdose, <b>LED-Aufbauleuchte LL94</b>, 6000 K, 7,4 W, 892 Lumen, EEK E <i>mirror cabinet, 2 doors mirrored on both sides, 4 glass boards, incl. switch/socket LED lighting LL94, 6000 K, 7,4 W 892 lumen, EEC E</i></p>	120,0	68,2	13,6	<b>SLLD12</b> 			<b>2007</b>
<p><b>Aufbauleuchte/top light</b></p>  <p>Spiegelpaneel, inkl. Schalter Mitte unten, <b>LED Aufbauleuchte FLS90, umschaltbar</b> <b>in 2 Lichtfarben, 4000/6000 K</b>, 17,5 W, 1390 Lumen, EEK G <i>mirror panel, incl. switch center below, LED lighting FLS90, two switchable luminous colours, 4000/6000 K, 17,5 W, 1390 lumen, EEC G</i></p>	120,0	68,2	2,8	<b>SPFLB12</b> 			<b>1822</b>
 <p>Spiegelpaneel ohne Beleuchtung <i>mirror panel without lighting</i></p>	120,0	68,2	2,8	<b>SPOO12</b>			<b>485</b>

EEK/EEC=Energieeffizienzklasse/energy efficiency category  
Leuchtmittel sind nicht austauschbar / illuminants are not interchangeable.

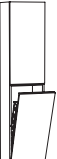
# 3350idea »Beistellschränke/ side cabinets«

Beschreibung Description	Maße in cm Dimensions in cm			Artikel-Nr. Article no.	Türanschlag Door stop	Identnummer ID number	
	B/W	H	T/D			PG1	PG3
 <p>Highboard inkl. Abdeckplatte 1 Tür 2 Glaseinlegeböden</p> <p><i>highboard incl. top 1 door 2 glass boards</i></p>	40,0	91,2	34,8	<b>CHBT4FL</b> <b>CHBT4FR</b>	Links/ <i>left</i> Rechts/ <i>right</i>	<b>692</b>	<b>854</b>
 <p>Highboard inkl. Abdeckplatte 1 Tür, 1 Schubkasten 2 Glaseinlegeböden</p> <p><i>highboard incl. top 1 door, 1 drawer 2 glass boards</i></p>	40,0	91,2	34,8	<b>CHBST4FL</b> <b>CHBST4FR</b>	Links/ <i>left</i> Rechts/ <i>right</i>	<b>923</b>	<b>1085</b>
 <p>Highboard inkl. Abdeckplatte 1 Tür/Wäschekippe</p> <p><i>highboard incl. top 1 door/linen bin</i></p>	40,0	91,2	34,8	<b>CHBW4F</b>		<b>761</b>	<b>923</b>
 <p>Mittelschrank inkl. Abdeckplatte 2 Türen 3 Glaseinlegeböden</p> <p><i>medium cabinet incl. top 2 doors 3 glass boards</i></p>	40,0	148,8	34,8	<b>CMTT4FL</b> <b>CMTT4FR</b>	Links/ <i>left</i> Rechts/ <i>right</i>	<b>1016</b>	<b>1292</b>
 <p>Mittelschrank inkl. Abdeckplatte 2 Türen, 1 Schubkasten 3 Glaseinlegeböden</p> <p><i>medium cabinet incl. top 2 doors, 1 drawer 3 glass boards</i></p>	40,0	148,8	34,8	<b>CMTST4FL</b> <b>CMTST4FR</b>	Links/ <i>left</i> Rechts/ <i>right</i>	<b>1292</b>	<b>1569</b>
 <p>Hochschrank 2 Türen 4 Glaseinlegeböden</p> <p><i>tower cabinet 2 doors 4 glass boards</i></p>	40,0	178,7	34,8	<b>CHTT4L</b> <b>CHTT4R</b>	Links/ <i>left</i> Rechts/ <i>right</i>	<b>1131</b>	<b>1453</b>
 <p>Hochschrank 2 Türen, 1 Schubkasten 3 Glaseinlegeböden</p> <p><i>tower cabinet 2 doors, 1 drawer 3 glass boards</i></p>	40,0	178,7	34,8	<b>CHTST4L</b> <b>CHTST4R</b>	Links/ <i>left</i> Rechts/ <i>right</i>	<b>1362</b>	<b>1684</b>
 <p>Hochschrank 1 Tür, 1 Tür/Wäschekippe 2 Glaseinlegeböden</p> <p><i>tower cabinet 1 door, 1 door/linen bin 2 glass boards</i></p>	40,0	178,7	34,8	<b>CHTW4L</b> <b>CHTW4R</b>	Links/ <i>left</i> Rechts/ <i>right</i>	<b>1200</b>	<b>1546</b>

Beschreibung Description	Maße in cm Dimensions in cm			Artikel-Nr. Article no.	Türanschlag Door stop	Identnummer ID number
	B/W	H	T/D			
 <p>Schubkasteneinsatz (Kunststoff) für oberen Auszug vom WT-Unterschrank <i>drawer insert part (plastic) for top drawer from base cabinet</i></p>	33,7	4,3	33,0	<b>SMBEG3</b>		<b>69</b>
 <p>Steckdose/Powerbox für Spiegelschränke Ausführung <b>Schweiz</b> IP44 mit USB-C Stecker <i>Power socket for mirror cabinets Switzerland type IP44 with USB-C plug</i></p>				<b>Mehrpreis extra charge</b>		<b>138</b>
 <p>Steckdose/Powerbox für Spiegelschränke Ausführung <b>Frankreich</b> mit USB-C Stecker <i>Power socket for mirror cabinets France type with USB-C plug</i></p>				<b>Mehrpreis extra charge</b>		<b>138</b>

**i** Weiteres Zubehör finden Sie im Register 3970.  
Further accessories can be found in register 3970.





# 3400modern





# »3400modern«

Piktogramme/pictograms



Keramik Waschtisch  
Ceramic washbasin



LED Lichtfarbe kalt  
LED colour temperature cold

## Keramik Waschtisch weiß alpin Glanz (ASK) Ceramic washbasin gloss alpine white (ASK)

 ≈ Beckenmaße in cm (BxHxT)  
basin dimensions in cm (WxHxD)

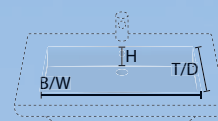

KWSOF8 |  58 x 11,5 x 31 cm



KWSOF10 |  58 x 11,5 x 31 cm



Detail

**!** Immer im Lieferumfang der Keramikwaschtische enthalten: Befestigungsmaterial MONK-4  
Always included in the scope of delivery of the ceramic washbasins: mounting material MONK-4

Wir empfehlen eine Montage nur durch einen qualifizierten Monteur/Installateur. Keine Haftung bei unsachgemäßer Montage.  
MONK-4: 2 Stockschrauben M10x120 inkl. Dübel für massive Steinwand. Bei anderen Wandbeschaffenheiten müssen im Fachhandel entsprechende Dübel erworben werden.

We recommend installation only by a qualified fitter / installer. No liability for improper installation.  
MONK-4: 2 screws M10x120 including dowels for a solid stone wall. For other wall conditions, suitable dowels must be purchased from a specialised dealer.

## Schränke/cabinets 3400modern

### Frontfarben/front colours

#### Dickkante/thick edge

286



**Weiß Seidenglanz**  
*Silk Gloss White*  
ASE\_

420

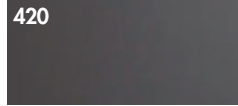

**Anthrazit Matt** NEW  
*Matt Anthracite*  
ASN\_

473



**Eiche Struktur Natur Nachbildung**  
*Oak Structure Nature Finish*  
ASM\_

435



**Eiche Struktur Weiß Nachbildung** NEW  
*Oak Structure White Finish*  
ASL\_

426



**Eiche Struktur Braun Nachbildung** NEW  
*Oak Structure Brown Finish*  
ASH\_

### Korpusfarben/basic shell colours

#### PG 1 Dickkante/thick edge

030

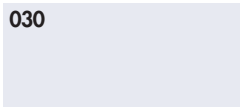

**Weiß Matt**  
*Matt White*  
W/AS90

### Aufdopplungsseiten/side panels 10 mm

287



**Weiß Seidenglanz**  
*Silk Gloss White*  
E/AS86

421



**Anthrazit Matt**  
*Matt Anthracite*  
N/AS20

474



**Eiche Struktur Natur Nachbildung**  
*Oak Structure Nature Finish*  
M/AS55

436



**Eiche Struktur Weiß Nachbildung** NEW  
*Oak Structure White Finish*  
L/AS40

427



**Eiche Struktur Braun Nachbildung** NEW  
*Oak Structure Brown Finish*  
H/AS70

# »3400modern«

## Griffe/handles



**Chrom Glanz**  
Gloss Chrome  
Griffnummer/handlenumber: 263/264  
⌀—⌀ 128 mm/320 mm

⌀—⌀ = Bohrabstand/hole spacing



**Schwarz Matt Struktur**  
Matt Black Structure  
Griffnummer/handlenumber: 237/238  
⌀—⌀ 128 mm/320 mm

**Die Angabe einer Griffnummer ist ausreichend. Die Griffe werden passend zur jeweiligen Schrankbreite beigelegt.**  
*The indication of one handle number is sufficient. The handles are supplied to match the respective cabinet width.*

## Beleuchtung / lighting



**Aufbauleuchte LED**  
Top light LED



**Lichtfarbe Tageslicht (Kalt)**  
Luminous colour natural light (cold)

DE60

**Die Steckdose / Powerbox für Spiegelschränke ist auch in Ausführung für die Schweiz / Frankreich erhältlich. Bitte Mehrpreis beachten (siehe Seite 8).**  
*The power socket for mirror cabinets is also available for Switzerland / France. Please note extra charge (see page 8).*



# 3400modern »Beispiel-Kombinationen/example-combinations«



Beschreibung Description	Maße in cm Dimensions in cm			Artikel-Nr. Article no.	Türanschlag Door stop	Identnummer ID number
	B/W	H	T/D			
PG1						
 <p>Kombination 80 cm bestehend aus: Spiegelschrank, 3 Spiegeltüren Keramik Waschtisch Waschtisch-Unterschrank, 1 feste Blende, 1 Schubkasten Highboard inkl. Abdeckplatte 16 mm Hochschrank</p> <p><i>combination 80 cm width consisting of: mirror cabinet, 3 mirror doors ceramic washbasin washbasin base cabinet, 1 fixed cover, 1 drawer high cabinet incl. top 16 mm tower cabinet</i></p>				<b>SLEB8</b> <b>KWSOF8</b> <b>WKDBS7</b>  <b>HBST4F</b> <b>HTST4</b>	  	1016 530 577  877 1154 <hr/> 4154
 <p>Kombination 80 cm bestehend aus: Spiegelschrank, 3 Spiegeltüren Keramik Waschtisch Waschtisch-Unterschrank, 1 Schubkasten, 1 Auszug Mittelschrank inkl. Abdeckplatte 16 mm Mittelschrank inkl. Abdeckplatte 16 mm</p> <p><i>combination 80 cm width consisting of: mirror cabinet, 3 mirror doors ceramic washbasin washbasin base cabinet, 1 drawer, 1 extension medium cabinet incl. top 16 mm medium cabinet incl. top 16 mm</i></p>				<b>SLEB8</b> <b>KWSOF8</b> <b>WKDSA7</b>  <b>MTST4F</b> <b>MTST4F</b>	  	1016 530 946  1176 1176 <hr/> 4844
 <p>Kombination 82 cm bestehend aus: Spiegelschrank inkl. <b>Aufdopplung</b> 10 mm, 3 Spiegeltüren Keramik Waschtisch Waschtisch-Unterschrank mit <b>Aufdopplung</b> 10 mm, 1 feste Blende, 1 Schubkasten Mittelschrank inkl. Abdeckplatte und <b>Aufdopplung</b> 10 mm</p> <p><i>combination 82 cm width consisting of: mirror cabinet incl. <b>side panels</b> 10 mm, 3 mirror doors ceramic washbasin washbasin base cabinet incl. <b>side panels</b> 10 mm, 1 fixed cover, 1 drawer medium cabinet incl. <b>side panels</b>, incl. top 10 mm</i></p>				<b>SLEB8A</b> <b>KWSOF8</b> <b>WKDBS7A</b>  <b>MTST4A</b>	  	1154 530 739  1384  <hr/> 3807
 <p>Kombination 102 cm bestehend aus: Spiegelschrank inkl. <b>Aufdopplung</b> 10 mm, 3 Spiegeltüren Keramik Waschtisch Waschtisch-Unterschrank mit <b>Aufdopplung</b> 10 mm, 1 Schubkasten, 1 Auszug Highboard inkl. <b>Aufdopplung</b> 10 mm Highboard inkl. <b>Aufdopplung</b> 10 mm Mittelschrank inkl. <b>Aufdopplung</b>, inkl. Abdeckplatte 10 mm</p> <p><i>combination 102 cm width consisting of: mirror cabinet incl. <b>side panels</b> 10 mm, 3 mirror doors ceramic washbasin washbasin base cabinet incl. <b>side panels</b> 10 mm, 1 drawer, 1 extension high cabinet incl. <b>side panels</b> 10 mm high cabinet incl. <b>side panels</b> 10 mm medium cabinet incl. <b>side panels</b>, incl. top 10 mm</i></p>				<b>SLEB10A</b> <b>KWSOF10</b> <b>WKDSA9A</b>  <b>HBST4A</b> <b>HBST4A</b> <b>MTST4A</b>	  	1246 646 1246  1038 1038 1384 <hr/> 6598

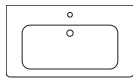

Handtuchhalter, Regale, Unterbaubeleuchtungen und weiteres Zubehör finden Sie in der Rubrik 3970zubehör.  
Towel rails, shelves, base lightings and other accessories can be found in the 3970accessories range.

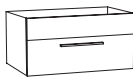

# 3400modern »80 cm Keramik/ceramic«

Beschreibung Description	Maße in cm Dimensions in cm			Artikel-Nr. Article no.	Türanschlag Door stop	Identnummer ID number
	B/W	H	T/D			

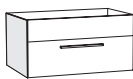

	Keramik-Waschtisch inkl. Überlauf und Befestigungsmaterial  <i>ceramic washbasin incl. overflow and mounting material</i>	80,0	3,0	45,5	<b>KWSOF8</b> 	<b>530</b>
---	--	------	-----	------	--	------------

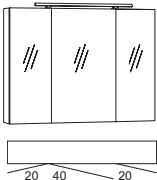
Ohne Aufdopplungsseiten / without side panels						PG1
	Waschtisch-Unterschrank 1 feste Blende, 1 Schubkasten  <i>washbasin base cabinet 1 fixed cover, 1 drawer</i>	75,0	37,6	44,0	<b>WKDBS7</b>	<b>577</b>
	Waschtisch-Unterschrank 1 Schubkasten, 1 Auszug  <i>washbasin base cabinet 1 drawer, 1 extension</i>	75,0	48,8	44,0	<b>WKDSA7</b>	<b>946</b>

Mit Aufdopplungsseiten / with side panels						
	Waschtisch-Unterschrank inklusive <b>Aufdopplungsseiten 10 mm</b> , 1 feste Blende, 1 Schubkasten  <i>washbasin base cabinet inclusive side panels 10 mm, 1 fixed cover, 1 drawer</i>	77,0	37,6	44,0	<b>WKDBS7A</b>	<b>739</b>
	Waschtisch-Unterschrank inklusive <b>Aufdopplungsseiten 10 mm</b> , 1 Schubkasten, 1 Auszug  <i>washbasin base cabinet inclusive side panels 10 mm, 1 drawer, 1 extension</i>	77,0	48,8	44,0	<b>WKDSA7A</b>	<b>1107</b>

Ohne Aufdopplungsseiten / without side panels						
	<b>Aufbauleuchte/top light</b> Spiegelschrank, 3 Spiegeltüren 6 Glaseinlegeböden, inkl. Schalter/ Steckdose, LED-Aufbauleuchte DE60, 6000 K, 8,0 W, 870 Lumen, EEK F  <i>mirror cabinet, 3 mirror doors 6 glass boards, incl. switch/socket LED lighting DE60, 6000 K, 8,0 W, 870 lumen, EEC F</i>	80,0	68,2	13,6	<b>SLEB8</b> 	<b>1016</b>

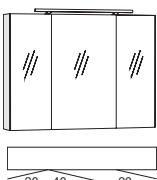
Dieses Produkt enthält eine Lichtquelle der Energieeffizienzklasse F

Mit Aufdopplungsseiten / with side panels						
	<b>Aufbauleuchte/top light</b> Spiegelschrank inklusive <b>Aufdopplungsseiten 10 mm</b> , 3 Spiegeltüren, 6 Glaseinlegeböden, inkl. Schalter/Steckdose LED-Aufbauleuchte DE60, 6000 K, 8,0 W, 870 Lumen, EEK F  <i>mirror cabinet inclusive side panels 10 mm, 3 mirror doors, 6 glass boards, incl. switch/socket, LED lighting DE60, 6000 K, 8,0 W, 870 lumen, EEC F</i>	82,0	68,2	13,6	<b>SLEB8A</b> 	<b>1154</b>



Dieses Produkt enthält eine Lichtquelle der Energieeffizienzklasse F



EEK/EEC=Energieeffizienzklasse/energy efficiency category  
Leuchtmittel sind nicht austauschbar / illuminants are not interchangeable.

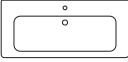

 Farben der Aufdopplungsseiten unbedingt mit angeben, Übersicht siehe Seite 2. Please indicate side panel colours, overview see page 2.



# 3400modern »100 cm Keramik/ceramic«



Beschreibung Description	Maße in cm Dimensions in cm			Artikel-Nr. Article no.	Türanschlag Door stop	Identnummer ID number
	B/W	H	T/D			

	Keramik-Waschtisch inkl. Überlauf und Befestigungsmaterial  <i>ceramic washbasin incl. overflow and mounting material</i>	101,0	3,0	45,5	<b>KWSOF10</b> 	<b>646</b>
---	--	-------	-----	------	---	------------

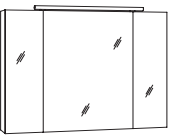
Ohne Aufdopplungsseiten / without side panels						PG1
	Waschtisch-Unterschrank 1 feste Blende, 1 Schubkasten  <i>washbasin base cabinet 1 fixed cover, 1 drawer</i>	95,0	37,6	44,0	<b>WKDBS9</b>	<b>715</b>
	Waschtisch-Unterschrank 1 Schubkasten, 1 Auszug  <i>washbasin base cabinet 1 drawer, 1 extension</i>	95,0	48,8	44,0	<b>WKDSA9</b>	<b>1085</b>

Mit Aufdopplungsseiten / with side panels						
	Waschtisch-Unterschrank inklusive <b>Aufdopplungsseiten 10 mm</b> , 1 feste Blende, 1 Schubkasten  <i>washbasin base cabinet inclusive side panels 10 mm 1 fixed cover, 1 drawer</i>	97,0	37,6	44,0	<b>WKDBS9A</b>	<b>854</b>
	Waschtisch-Unterschrank inklusive <b>Aufdopplungsseiten 10 mm</b> , 1 Schubkasten, 1 Auszug  <i>washbasin base cabinet inclusive side panels 10 mm, 1 drawer, 1 extension</i>	97,0	48,8	44,0	<b>WKDSA9A</b>	<b>1246</b>

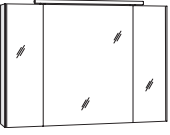
Ohne Aufdopplungsseiten / without side panels						
	<b>Aufbauleuchte/top light</b> Spiegelschrank, 3 Spiegeltüren 6 Glaseinlegeböden, inkl. Schalter/ Steckdose, LED-Aufbauleuchte DE60, 6000 K, 8,0 W, 870 Lumen, EEK F  <i>mirror cabinet, 3 mirror doors 6 glass boards, incl. switch/socket LED lighting DE60, 6000 K, 8,0 W, 870 lumen, EEC F</i>	100,0	68,2	13,6	<b>SLEB10</b> 	<b>1107</b>
Dieses Produkt enthält eine Lichtquelle der Energieeffizienzklasse F						

Mit Aufdopplungsseiten / with side panels						
	<b>Aufbauleuchte/top light</b> Spiegelschrank inklusive <b>Aufdopplungsseiten 10 mm</b> , 3 Spiegeltüren, 6 Glaseinlegeböden, inkl. Schalter/Steckdose LED-Aufbauleuchte DE60, 6000 K, 8,0 W, 870 Lumen, EEK F  <i>mirror cabinet inclusive side panels 10 mm, 3 mirror doors, 6 glass boards, incl. switch/socket, LED lighting DE60, 6000 K, 8,0 W, 870 lumen, EEC F</i>	102,0	68,2	13,6	<b>SLEB10A</b> 	<b>1246</b>
Dieses Produkt enthält eine Lichtquelle der Energieeffizienzklasse F						

EEK/EEC=Energieeffizienzklasse/energy efficiency category



Leuchtmittel sind nicht austauschbar / illuminants are not interchangeable.





 Farben der Aufdopplungsseiten unbedingt mit angeben, Übersicht siehe Seite 2. Please indicate side panel colours, overview see page 2.





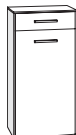

# 3400modern »Beistellschränke/ side cabinets«

Beschreibung Description	Maße in cm Dimensions in cm			Artikel-Nr. Article no.	Türanschlag Door stop	Identnummer ID number
	B/W	H	T/D			

Ohne Aufdopplungsseiten / without side panels						PG1	
	Highboard inklusive Abdeckplatte 16 mm 1 Tür, 1 Schubkasten 2 Glaseinlegeböden  <i>high cabinet inclusive top 16 mm 1 door, 1 drawer 2 glass boards</i>	40,0	91,0	35,0	<b>HBST4FL</b> <b>HBST4FR</b>	Links/ <i>left</i> Rechts/ <i>right</i>	<b>877</b>
	Mittelschrank inkl. Abdeckplatte 16 mm 2 Türen, 1 Schubkasten 3 Glaseinlegeböden  <i>medium cabinet inclusive top 16 mm 2 doors, 1 drawer 3 glass boards</i>	40,0	148,6	35,0	<b>MTST4FL</b> <b>MTST4FR</b>	Links/ <i>left</i> Rechts/ <i>right</i>	<b>1176</b>
	Hochschrank 2 Türen, 1 Schubkasten 3 Glaseinlegeböden  <i>tower cabinet 2 doors / 1 drawer 3 glass boards</i>	40,0	178,7	35,0	<b>HTST4L</b> <b>HTST4R</b>	Links/ <i>left</i> Rechts/ <i>right</i>	<b>1154</b>

Mit Aufdopplungsseiten / with side panels							
 	Highboard inklusive <b>Aufdopplungsseiten und Abdeckplatte 10 mm</b> 1 Tür, 1 Schubkasten 2 Glaseinlegeböden  <i>high cabinet inclusive side panels and top 10 mm 1 door, 1 drawer 2 glass boards</i>	42,0	90,4	35,0	<b>HBST4AL</b> <b>HBST4AR</b>	Links/ <i>left</i> Rechts/ <i>right</i>	<b>1038</b>
 	Mittelschrank inklusive <b>Aufdopplungsseiten und Abdeckplatte 10 mm</b> 2 Türen, 1 Schubkasten 3 Glaseinlegeböden  <i>medium cabinet inclusive side panels and top 10 mm 2 doors, 1 drawer 3 glass boards</i>	42,0	148,0	35,0	<b>MTST4AL</b> <b>MTST4AR</b>	Links/ <i>left</i> Rechts/ <i>right</i>	<b>1384</b>
 	Hochschrank inklusive <b>Aufdopplungsseiten und Abdeckplatte 10 mm</b> , 2 Türen, 1 Schubkasten 3 Glaseinlegeböden  <i>tower cabinet inclusive side panels and top 10 mm 2 doors / 1 drawer 3 glass boards</i>	42,0	179,7	35,0	<b>HTST4AL</b> <b>HTST4AR</b>	Links/ <i>left</i> Rechts/ <i>right</i>	<b>1569</b>

 Farben der Aufdopplungsseiten unbedingt mit angeben, Übersicht siehe Seite 2. Please indicate side panel colours, overview see page 2.

Beschreibung Description	Maße in cm Dimensions in cm			Artikel-Nr. Article no.	Türanschlag Door stop	Identnummer ID number
	B/W	H	T/D			
 <p>Schubkasteneinsatz (Kunststoff) für oberen Auszug vom WT-Unterschrank <i>drawer insert part (plastic) for top drawer from base cabinet</i></p>	33,7	4,3	33,0	<b>SMBEG3</b>		<b>69</b>
 <p>Steckdose/Powerbox für Spiegelschränke Ausführung <b>Schweiz</b> IP44 mit USB-C Stecker <i>Power socket for mirror cabinets Switzerland type IP44 with USB-C plug</i></p>				<b>Mehrpreis extra charge</b>		<b>138</b>
 <p>Steckdose/Powerbox für Spiegelschränke Ausführung <b>Frankreich</b> mit USB-C Stecker <i>Power socket for mirror cabinets France type with USB-C plug</i></p>				<b>Mehrpreis extra charge</b>		<b>138</b>

**i** Weiteres Zubehör finden Sie im Register 3970.  
Further accessories can be found in register 3970.

# MARLIN BAD

BEISTELLSCHRÄNKE, SPIEGEL, ZUBEHÖR, INFOS

# MARLIN BAD

SIDE CABINETS, MIRRORS, ACCESSORIES, INFO





# 3970zubehör





# »3970zubehör« Farb-Varianten/colour options

## Piktogramme/pictograms



LED Lichtfarbe kalt  
LED colour temperature cold



LED Lichtfarbe warm  
LED colour temperature warm



LED mit Bewegungssensor  
LED with motion sensor



LED Lichtfarbe schaltbar bzw. regelbar  
LED colour temperature adjustable

## Regale/shelves 3970zubehör

### Regalfarben /shelf colours

287



**Weiß Seidenglanz**  
Silk Gloss White  
MZ86

285



**Anthrazit Seidenglanz**  
Silk Gloss Anthracite  
MZ84

491



**Kastanie Graphit Nachbildung**  
Graphite Chestnut Finish  
MZ45

474



**Eiche Struktur Natur Nachbildung**  
Oak Structure Nature Finish  
MZ55

436



**Eiche Struktur Weiß Nachbildung**  
Oak Structure White Finish  
MZ40

427



**Eiche Struktur Braun Nachbildung**  
Oak Structure Brown Finish  
MZ70

## Steckbodenfarben/plugin shelves colours 3970zubehör

### PG 1 Dickkante/thick edge

287



**Weiß Seidenglanz**  
Silk Gloss White  
MZ86

285



**Anthrazit Seidenglanz**  
Silk Gloss Anthracite  
MZ84

491



**Kastanie Graphit Nachbildung**  
Graphite Chestnut Finish  
MZ45

474



**Eiche Struktur Natur Nachbildung**  
Oak Structure Nature Finish  
MZ55

436



**Eiche Struktur Weiß Nachbildung**  
Oak Structure White Finish  
MZ40

427



**Eiche Struktur Braun Nachbildung**  
Oak Structure Brown Finish  
MZ70

### PG 3 MDF-foliert/MDF-coated

042



**Weiß Glanz Folie**  
Gloss White  
MZ50











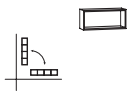

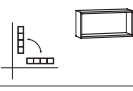

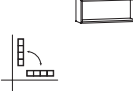

438

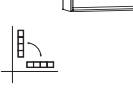

**Anthrazit Glanz Folie**  
Gloss Anthracite  
MZ30

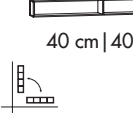
# 3970zubehör »Regale in Tiefe 11,6 cm/shelves in depth 11.6 cm«

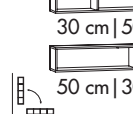
Beschreibung Description	Maße in cm Dimensions in cm			Artikel-Nr. Article no.	Türanschlag Door stop	Identnummer ID number
	B/W	H	T/D			

Die Regale sind in der Tiefe von 11,6 cm kompatibel mit den Spiegelschränken aus den Programmen <b>3130, 3160, 3250</b> und <b>3400</b> .						
With a depth of 11.60 cm, the shelves are compatible with the mirror cabinets from the <b>3130, 3160, 3250</b> and <b>3400</b> ranges.						
 	Regal für Montage unter Spiegelschrank/ Spiegelpaneel oder frei hängend inkl. Aufhänger  <i>shelf for mounting under mirror cabinet/ mirror panel or free hanging incl. hanging brackets</i>	40,0	17,0	11,6	<b>SRA4</b>	<b>254</b>
 	Regal für Montage unter Spiegelschrank/ Spiegelpaneel oder frei hängend inkl. Aufhänger  <i>shelf for mounting under mirror cabinet/ mirror panel or free hanging incl. hanging brackets</i>	45,0	17,0	11,6	<b>SRA45</b>	<b>262</b>
 	Regal für Montage unter Spiegelschrank/ Spiegelpaneel oder frei hängend inkl. Aufhänger  <i>shelf for mounting under mirror cabinet/ mirror panel or free hanging incl. hanging brackets</i>	50,0	17,0	11,6	<b>SRA5</b>	<b>277</b>
 	Regal für Montage unter Spiegelschrank/ Spiegelpaneel oder frei hängend inkl. Aufhänger  <i>shelf for mounting under mirror cabinet/ mirror panel or free hanging incl. hanging brackets</i>	60,0	17,0	11,6	<b>SRA6</b>	<b>288</b>
 	Regal für Montage unter Spiegelschrank/ Spiegelpaneel oder frei hängend inkl. Aufhänger  <i>shelf for mounting under mirror cabinet/ mirror panel or free hanging incl. hanging brackets</i>	70,0	17,0	11,6	<b>SRA7</b>	<b>309</b>
 	Regal für Montage unter Spiegelschrank/ Spiegelpaneel oder frei hängend inkl. Aufhänger  <i>shelf for mounting under mirror cabinet/ mirror panel or free hanging incl. hanging brackets</i>	80,0	17,0	11,6	<b>SRA8</b>	<b>340</b>
  40 cm   40 cm	Regal für Montage unter Spiegelschrank/ Spiegelpaneel oder frei hängend inkl. Aufhänger  <i>shelf for mounting under mirror cabinet/ mirror panel or free hanging incl. hanging brackets</i>	80,0	17,0	11,6	<b>SRA8-44</b>	<b>340</b>
  30 cm   50 cm  50 cm   30 cm	Regal für Montage unter Spiegelschrank/ Spiegelpaneel oder frei hängend inkl. Aufhänger  <i>shelf for mounting under mirror cabinet/ mirror panel or free hanging incl. hanging brackets</i>	80,0	17,0	11,6	<b>SRA8-35</b> <b>SRA8-53</b>	<b>340</b>

 Regalfarben unbedingt mit angeben, Übersicht siehe Seite 1. Please indicate shelf colours, overview see page 1.



# 3970zubehör »Regale in Tiefe 11,6 cm/shelves in depth 11.6 cm«

Beschreibung Description	Maße in cm Dimensions in cm			Artikel-Nr. Article no.	Türanschlag Door stop	Identnummer ID number
	B/W	H	T/D			

Die Regale sind in der Tiefe von 11,6 cm kompatibel mit den Spiegelschränken aus den Programmen **3130, 3160, 3250** und **3400**.

With a depth of 11.60 cm, the shelves are compatible with the mirror cabinets from the **3130, 3160, 3250** and **3400** ranges.

 	<p>Regal für Montage unter Spiegelschrank/ Spiegelpaneel oder frei hängend inkl. Aufhänger</p> <p><i>shelf for mounting under mirror cabinet/ mirror panel or free hanging incl. hanging brackets</i></p>	90,0	17,0	11,6	<b>SRA9</b>		<b>357</b>
  <p>30 cm   60 cm</p>	<p>Regal für Montage unter Spiegelschrank/ Spiegelpaneel oder frei hängend inkl. Aufhänger</p> <p><i>shelf for mounting under mirror cabinet/ mirror panel or free hanging incl. hanging brackets</i></p>	90,0	17,0	11,6	<b>SRA9-36</b>		<b>357</b>
  <p>45 cm   45 cm</p>	<p>Regal für Montage unter Spiegelschrank/ Spiegelpaneel oder frei hängend inkl. Aufhänger</p> <p><i>shelf for mounting under mirror cabinet/ mirror panel or free hanging incl. hanging brackets</i></p>	90,0	17,0	11,6	<b>SRA9-4545</b>		<b>357</b>
  <p>50 cm   50 cm</p>	<p>Regal für Montage unter Spiegelschrank/ Spiegelpaneel oder frei hängend inkl. Aufhänger</p> <p><i>shelf for mounting under mirror cabinet/ mirror panel or free hanging incl. hanging brackets</i></p>	100,0	17,0	11,6	<b>SRA10-55</b>		<b>374</b>
  <p>40 cm   60 cm 60 cm   40 cm</p>	<p>Regal für Montage unter Spiegelschrank/ Spiegelpaneel oder frei hängend inkl. Aufhänger</p> <p><i>shelf for mounting under mirror cabinet/ mirror panel or free hanging incl. hanging brackets</i></p>	100,0	17,0	11,6	<b>SRA10-46</b> <b>SRA10-64</b>		<b>374</b>
  <p>60 cm   60 cm</p>	<p>Regal für Montage unter Spiegelschrank/ Spiegelpaneel oder frei hängend inkl. Aufhänger</p> <p><i>shelf for mounting under mirror cabinet/ mirror panel or free hanging incl. hanging brackets</i></p>	120,0	17,0	11,6	<b>SRA12-66</b>		<b>407</b>
  <p>35   60   35 cm</p>	<p>Regal für Montage unter Spiegelschrank/ Spiegelpaneel oder frei hängend inkl. Aufhänger</p> <p><i>shelf for mounting under mirror cabinet/ mirror panel or free hanging incl. hanging brackets</i></p>	130,0	17,0	11,6	<b>SRA13-363</b>		<b>452</b>
  <p>40   50   40 cm</p>	<p>Regal für Montage unter Spiegelschrank/ Spiegelpaneel oder frei hängend inkl. Aufhänger</p> <p><i>shelf for mounting under mirror cabinet/ mirror panel or free hanging incl. hanging brackets</i></p>	130,0	17,0	11,6	<b>SRA13-454</b>		<b>452</b>

 Regalfarben unbedingt mit angeben, Übersicht siehe Seite 1. Please indicate shelf colours, overview see page 1.

# 3970zubehör »Regale in Tiefe 11,6 cm/shelves in depth 11.6 cm«

Beschreibung Description	Maße in cm Dimensions in cm			Artikel-Nr. Article no.	Türanschlag Door stop	Identnummer ID number
	B/W	H	T/D			

Die Regale sind in der Tiefe von 11,6 cm kompatibel mit den Spiegelschränken aus den Programmen **3130, 3160, 3250 und 3400**.

With a depth of 11.60 cm, the shelves are compatible with the mirror cabinets from the **3130, 3160, 3250 and 3400** ranges.









 <p>65 cm   65 cm</p>	<p>Regal für Montage unter Spiegelschrank/ Spiegelpaneel oder frei hängend inkl. Aufhänger</p> <p><i>shelf for mounting under mirror cabinet/ mirror panel or free hanging incl. hanging brackets</i></p>	130,0	17,0	11,6	<b>SRA13-6565</b>	<b>452</b>
 <p>50 cm   40 cm   50 cm</p>	<p>Regal für Montage unter Spiegelschrank/ Spiegelpaneel oder frei hängend inkl. Aufhänger</p> <p><i>shelf for mounting under mirror cabinet/ mirror panel or free hanging incl. hanging brackets</i></p>	140,0	17,0	11,6	<b>SRA14-545</b>	<b>465</b>
 <p>60 cm   80 cm</p>	<p>Regal für Montage unter Spiegelschrank/ Spiegelpaneel oder frei hängend inkl. Aufhänger</p> <p><i>shelf for mounting under mirror cabinet/ mirror panel or free hanging incl. hanging brackets</i></p>	140,0	17,0	11,6	<b>SRA14-68</b>	<b>465</b>
 <p>70 cm   70 cm</p>	<p>Regal für Montage unter Spiegelschrank/ Spiegelpaneel oder frei hängend inkl. Aufhänger</p> <p><i>shelf for mounting under mirror cabinet/ mirror panel or free hanging incl. hanging brackets</i></p>	140,0	17,0	11,6	<b>SRA14-77</b>	<b>465</b>
 <p>45 cm   60 cm   45 cm</p>	<p>Regal für Montage unter Spiegelschrank/ Spiegelpaneel oder frei hängend inkl. Aufhänger</p> <p><i>shelf for mounting under mirror cabinet/ mirror panel or free hanging incl. hanging brackets</i></p>	150,0	17,0	11,6	<b>SRA15-464</b>	<b>487</b>
 <p>60 cm   60 cm   30 cm</p>	<p>Regal für Montage unter Spiegelschrank/ Spiegelpaneel oder frei hängend inkl. Aufhänger</p> <p><i>shelf for mounting under mirror cabinet/ mirror panel or free hanging incl. hanging brackets</i></p>	150,0	17,0	11,6	<b>SRA15-663</b>	<b>487</b>
 <p>60 cm   40 cm   60 cm</p>	<p>Regal für Montage unter Spiegelschrank/ Spiegelpaneel oder frei hängend inkl. Aufhänger</p> <p><i>shelf for mounting under mirror cabinet/ mirror panel or free hanging incl. hanging brackets</i></p>	160,0	17,0	11,6	<b>SRA16-646</b>	<b>521</b>
 <p>80 cm   80 cm</p>	<p>Regal für Montage unter Spiegelschrank/ Spiegelpaneel oder frei hängend inkl. Aufhänger</p> <p><i>shelf for mounting under mirror cabinet/ mirror panel or free hanging incl. hanging brackets</i></p>	160,0	17,0	11,6	<b>SRA16-88</b>	<b>521</b>

 Regalfarben unbedingt mit angeben, Übersicht siehe Seite 1. Please indicate shelf colours, overview see page 1.

Beschreibung Description	Maße in cm Dimensions in cm			Artikel-Nr. Article no.	Türanschlag Door stop	Identnummer ID number
	B/W	H	T/D			

Die Regale sind in der Tiefe von 11,6 cm kompatibel mit den Spiegelschränken aus den Programmen 3130, 3160, 3250 und 3400.

With a depth of 11.60 cm, the shelves are compatible with the mirror cabinets from the 3130, 3160, 3250 and 3400 ranges.

<p><b>i</b></p>  <p>70 30 70 cm</p> 	<p>Regal für Montage unter Spiegelschrank/ Spiegelpaneel oder frei hängend inkl. Aufhänger</p> <p>shelf for mounting under mirror cabinet/ mirror panel or free hanging incl. hanging brackets</p>	170,0	17,0	11,6	<b>SRA17-737</b>		<b>586</b>
<p><b>i</b></p>  	<p>Regal für seitliche Montage oder frei- hängend, inkl. Aufhänger 3 feste Einlegeböden</p> <p>shelf for side mounting or free-hanging incl. hanging brackets 3 fixed shelves</p>	15,0	68,2	11,6	<b>REA15</b>		<b>345</b>
<p><b>i</b></p>  	<p>Regal für seitliche Montage oder frei- hängend, inkl. Aufhänger 3 feste Einlegeböden</p> <p>shelf for side mounting or free-hanging incl. hanging brackets 3 fixed shelves</p>	20,0	68,2	11,6	<b>REA20</b>		<b>372</b>
<p><b>i</b></p> 	<p>Winkelablage unten mit satiniertem Glas- boden für Spiegelschrank/Spiegelpaneel inkl. Aufhänger</p> <p>Bottom angle shelf with frosted glass base for mirror cabinet/mirror panel incl. hanging brackets</p>	45,0	15,8	12,6	<b>SRP45</b>		<b>219</b>
<p><b>i</b></p> 	<p>Winkelablage unten mit satiniertem Glas- boden für Spiegelschrank/Spiegelpaneel inkl. Aufhänger</p> <p>Bottom angle shelf with frosted glass base for mirror cabinet/mirror panel incl. hanging brackets</p>	60,0	15,8	12,6	<b>SRP6</b>		<b>253</b>

**i** Regalfarben unbedingt mit angeben, Übersicht siehe Seite 1. Please indicate shelf colours, overview see page 1.

# 3970zubehör »Regale in Tiefe 15,6 cm/shelves in depth 15.6 cm«

Beschreibung Description	Maße in cm Dimensions in cm			Artikel-Nr. Article no.	Türanschlag Door stop	Identnummer ID number
	B/W	H	T/D			

Die Regale sind in der Tiefe von 15,6 cm kompatibel mit den Spiegelschränken aus den Programmen **3020, 3040, 3060, 3090, 3100, 3260, 3280, 3290, 3350, 3360, 3390** und **3460**.

With a depth of 15.60 cm, the shelves are compatible with the mirror cabinets from the **3020, 3040, 3060, 3090, 3100, 3260, 3280, 3290, 3350, 3360, 3390** and **3460** ranges.

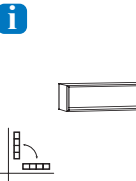
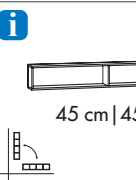
 <p>Regal für Montage unter Spiegelschrank/ Spiegelpaneel oder frei hängend inkl. Aufhänger</p> <p><i>shelf for mounting under mirror cabinet/ mirror panel or free hanging incl. hanging brackets</i></p>	45,0	17,0	15,6	<b>SRB45</b>		<b>266</b>
 <p>Regal für Montage unter Spiegelschrank/ Spiegelpaneel oder frei hängend inkl. Aufhänger</p> <p><i>shelf for mounting under mirror cabinet/ mirror panel or free hanging incl. hanging brackets</i></p>	60,0	17,0	15,6	<b>SRB6</b>		<b>295</b>
 <p>Regal für Montage unter Spiegelschrank/ Spiegelpaneel oder frei hängend inkl. Aufhänger</p> <p><i>shelf for mounting under mirror cabinet/ mirror panel or free hanging incl. hanging brackets</i></p>	80,0	17,0	15,6	<b>SRB8</b>		<b>346</b>
 <p>Regal für Montage unter Spiegelschrank/ Spiegelpaneel oder frei hängend inkl. Aufhänger</p> <p>30 cm   50 cm 50 cm   30 cm</p> <p><i>shelf for mounting under mirror cabinet/ mirror panel or free hanging incl. hanging brackets</i></p>	80,0	17,0	15,6	<b>SRB8-35</b> <b>SRB8-53</b>		<b>346</b>
 <p>Regal für Montage unter Spiegelschrank/ Spiegelpaneel oder frei hängend inkl. Aufhänger</p> <p><i>shelf for mounting under mirror cabinet/ mirror panel or free hanging incl. hanging brackets</i></p>	90,0	17,0	15,6	<b>SRB9</b>		<b>364</b>
 <p>Regal für Montage unter Spiegelschrank/ Spiegelpaneel oder frei hängend inkl. Aufhänger</p> <p>30 cm   60 cm</p> <p><i>shelf for mounting under mirror cabinet/ mirror panel or free hanging incl. hanging brackets</i></p>	90,0	17,0	15,6	<b>SRB9-36</b>		<b>364</b>
 <p>Regal für Montage unter Spiegelschrank/ Spiegelpaneel oder frei hängend inkl. Aufhänger</p> <p>45 cm   45 cm</p> <p><i>shelf for mounting under mirror cabinet/ mirror panel or free hanging incl. hanging brackets</i></p>	90,0	17,0	15,6	<b>SRB9-4545</b>		<b>364</b>
 <p>Regal für Montage unter Spiegelschrank/ Spiegelpaneel oder frei hängend inkl. Aufhänger</p> <p><i>shelf for mounting under mirror cabinet/ mirror panel or free hanging incl. hanging brackets</i></p>	100,0	17,0	15,6	<b>SRB10</b>		<b>392</b>





 Regalfarben unbedingt mit angeben, Übersicht siehe Seite 1. Please indicate shelf colours, overview see page 1.

# 3970zubehör »Regale in Tiefe 15,6 cm und Steckböden/shelves in depth 15.6 cm and plug-in shelves«



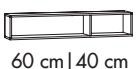

Beschreibung Description	Maße in cm Dimensions in cm			Artikel-Nr. Article no.	Türanschlag Door stop	Identnummer ID number
	B/W	H	T/D			

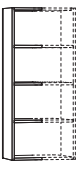
Die Regale sind in der Tiefe von 15,6 cm kompatibel mit den Spiegelschränken aus den Programmen 3020, 3040, 3060, 3090, 3100, 3260, 3280, 3290, 3350, 3360, 3390 und 3460.









With a depth of 15.60 cm, the shelves are compatible with the mirror cabinets from the 3020, 3040, 3060, 3090, 3100, 3260, 3280, 3290, 3350, 3360, 3390 and 3460 ranges.

 60 cm   40 cm	Regal für Montage unter Spiegelschrank/ Spiegelpaneel oder frei hängend inkl. Aufhänger	100,0	17,0	15,6	SRB10-64	392
 60 cm   60 cm	Regal für Montage unter Spiegelschrank/ Spiegelpaneel oder frei hängend inkl. Aufhänger	120,0	17,0	15,6	SRB12-66	417
	Regal für seitliche Montage oder frei- hängend, inkl. Aufhänger 3 feste Einlegeböden	15,0	68,2	15,6	REB15	353
	Regal für seitliche Montage oder frei- hängend, inkl. Aufhänger 3 feste Einlegeböden	20,0	68,2	15,6	REB20	378
	Oberschrankregal für Spiegelschrank/- paneel 3 feste Einlegeböden, inkl. Aufhängung <b>Bei Bestellung Breite des Regals an- geben!</b>	15,0 - 60,0	68,2	15,6	REBV	769

Das Regal REBV kann in cm-Schritten von 15-60 cm Breite individuell bestellt werden / The shelf REBV can be ordered in a width of 15 to 60 cm.

						PG 1	PG 3
	Steckboden für Spiegelschrank-/paneel Unterseite weiß, inkl. 2 Wandhaltern chrom	40,0	1,6	12,4	SB4	221	240
	Steckboden für Spiegelschrank-/paneel Unterseite weiß, inkl. 2 Wandhaltern chrom	80,0	1,6	12,0	SB8	254	273
	Steckboden für Spiegelschrank-/paneel Unterseite weiß, inkl. 2 Wandhaltern chrom	100,0	1,6	12,0	SB10	268	314
	Steckboden für Spiegelschrank-/paneel Unterseite weiß, inkl. 2 Wandhaltern chrom	120,0	1,6	12,0	SB12	277	346

 Gewünschtes Dekor für Regale und Steckböden bitte unbedingt mit angeben, Übersicht siehe Seite 1. Please indicate shelf colours, overview see page 1.

Beschreibung Description	Maße in cm Dimensions in cm			Artikel-Nr. Article no.	Türanschlag Door stop	Identnummer ID number
	B/W	H	T/D			
 <p>Handtuchhalter 1-armig Chrom Glanz (Befestigung am Schrank) <i>towel rail 1-arm glossy chrome (fastening on the cabinet)</i></p>	5,0	1,0	33,0	HHF133		102
 <p>Handtuchhalter 1-armig <b>Schwarz Matt</b> (Befestigung am Schrank) <i>towel rail 1-arm <b>mat black</b> (fastening on the cabinet)</i></p>	5,0	1,0	33,0	HHF133S		102
 <p>Handtuchhalter 1-armig Chrom Glanz (Befestigung am Schrank) ausziehbar <i>towel rail 1-arm glossy chrome (fastening on the cabinet) pull out</i></p>	7,5	4,0	32,5/ 50,0	HH133		125
 <p>Handtuchhalter 2-armig Chrom Glanz (Befestigung am Schrank) ausziehbar <i>towel rail 2-arms glossy chrome (fastening on the cabinet) pull out</i></p>	10,5	4,0	32,5/ 50,0	HH233		175
 <p>Handtuchhalter Chrome Glanz (Befestigung am Schrank) <b>Bitte beachten Sie die Tiefe der Waschtisch-Unterschänke</b> <i>towel rail glossy chrome (fastening on the cabinet) <b>Please note the depth of the washbasin base cabinets</b></i></p>	5,0	2,5	40,0	RHH		195
 <p>Spiegelschrank-Unterbaubeleuchtung LED 6000 K, 3,5 W, 350 Lumen, EEK F (für Spiegelschrank ab 60 cm Breite) <b>ohne</b> Verteiler und Konverter, Beleuchtung wird mit Konverter des Spiegelschranks betrieben. <b>Selbstmontage</b> unter Spiegelschrank (mit oder ohne Regal). <i>base lighting for mirror cabinet LED 6000 K, 3,5 W, 350 lumen EEC F (for mirror cabinet ex 60 cm width) <b>without</b> distributor and converter, lighting is used with converter of the mirror cabinet. <b>Self-assembly</b> under mirror-cabinet (with or without shelf).</i></p>	57,0			WTBP60 	Dieses Produkt enthält eine Lichtquelle der Energieeffizienzklasse F	162
 <p>Spiegelschrank-Unterbaubeleuchtung LED 6000 K, 3,5 W, 350 Lumen, EEK F (für Spiegelschrank ab 60 cm Breite) <b>inkl.</b> Verteiler und Konverter, nur für Spie- gelschränke mit der Aufbauleuchte DE60 in den Programmen 3400 und 3980. <b>Selbstmontage</b> unter Spiegelschrank (mit oder ohne Regal). <i>base lighting for mirror cabinet LED 6000 K, 3,5 W, 350 lumen EEC F (for mirror cabinet ex 60 cm width) <b>incl.</b> distributor and converter, only for mirror cabinets with LED top light DE60 in programmes 3400 and 3980. <b>Self-assembly</b> under mirror-cabinet (with or without shelf).</i></p>	57,0			WTBP60VK  3400,3980	Dieses Produkt enthält eine Lichtquelle der Energieeffizienzklasse F	323



EEK/EEC=Energieeffizienzklasse/energy efficiency category

Leuchtmittel sind nicht austauschbar / illuminants are not interchangeable.

Beschreibung Description	Maße in cm Dimensions in cm			Artikel-Nr. Article no.	Türanschlag Door stop	Identnummer ID number
	B/W	H	T/D			

 <p>Spiegelschrank-Unterbaubeleuchtung LED <b>regelbar</b> von 2800-6500 K, 3,5 W, 350 Lumen, EEK F (für Spiegelschrank ab 60 cm Breite) <b>ohne</b> Verteiler und Konverter, Beleuchtung wird mit Konverter des Spiegelschranks betrieben. <b>Selbstmontage</b> unter Spiegelschrank (mit oder ohne Regal).</p> <p><i>base lighting for mirror cabinet LED adjustable from 2800-6500 K, 3,5 W, 350 lumen, EEC F (for mirror cabinet ex 60 cm width) without distributor and converter, lighting is used with converter of the mirror cabinet. <b>Self-assembly</b> under mirror-cabinet (with or without shelf).</i></p>	57,0	<p><b>WTBPR60</b></p>  <p>Dieses Produkt enthält eine Lichtquelle der Energieeffizienzklasse F</p>	162
 <p>Spiegelschrank-Unterbaubeleuchtung LED 6000 K, 3,4 W, 252 Lumen, EEK G (für Spiegelschrank ab 80 cm Breite) <b>ohne</b> Verteiler und Konverter, Beleuchtung wird mit Konverter des Spiegelschranks betrieben. <b>Montage im Werk an der unteren Spiegelschrankrückwand; indirekte Beleuchtung für Waschtisch (nur ohne Regal möglich).</b></p> <p><i>base lighting for mirror cabinet LED 6000 K, 3,4 W, 252 lumen EEC G (for mirror cabinet ex 80 cm width) without distributor and converter lighting is used with converter of the mirror cabinet. <b>Factory mounting on lower mirror cabinet rear wall; indirect lighting for washbasin (only possible without shelf).</b></i></p>	70,0	<p><b>WTB70</b></p>  <p>Dieses Produkt enthält eine Lichtquelle der Energieeffizienzklasse G</p>	184
 <p>Spiegelschrank-Unterbaubeleuchtung LED 6000 K, 3,4 W, 252 Lumen, EEK G (für Spiegelschrank ab 80 cm Breite) <b>inkl.</b> Verteiler und Konverter, nur für Spie- gelschränke mit der Aufbauleuchte DE60 in den Programmen 3400 und 3980. <b>Montage im Werk an der unteren Spiegelschrankrückwand; indirekte Beleuchtung für Waschtisch (nur ohne Regal möglich).</b></p> <p><i>base lighting for mirror cabinet LED 6000 K, 3,4 W, 252 lumen EEC G (for mirror cabinet ex 80 cm width) incl. distributor and converter, only for mirror cabinets with LED top light DE60 in programmes 3400 and 3980. <b>Factory mounting on lower mirror cabinet rear wall; indirect lighting for washbasin (only possible without shelf).</b></i></p>	70,0	<p><b>WTB70VK</b></p>  <p>3400,3980</p> <p>Dieses Produkt enthält eine Lichtquelle der Energieeffizienzklasse G</p>	335



EEK/EEC=Energieeffizienzklasse/energy efficiency category  
Leuchtmittel sind nicht austauschbar / illuminants are not interchangeable.

Beschreibung <i>Description</i>	Maße in cm <i>Dimensions in cm</i>			Artikel-Nr. <i>Article no.</i>	Türanschlag <i>Door stop</i>	Identnummer <i>ID number</i>
	B/W	H	T/D			
<p>Spiegelschrank-Unterbaubeleuchtung LED 6000 K, 5,3 W, 396 Lumen, EEK G (für Spiegelschrank ab 120 cm Breite) <b>ohne</b> Verteiler und Konverter, Beleuchtung wird mit Konverter des Spiegelschranks betrieben. <b>Montage im Werk an der unteren Spiegelschrankrückwand; indirekte Beleuchtung für Waschtisch (nur ohne Regal möglich).</b></p> <p><i>base lighting for mirror cabinet LED 6000 K, 5,3 W, 396 lumen EEC G (for mirror cabinet ex 120 cm width) without distributor and converter lighting is used with converter of the mirror cabinet. Factory mounting on lower mirror cabinet rear wall; indirect lighting for washbasin (only possible without shelf).</i></p>	110,0			<p><b>WTB1 10</b></p> <p></p> <p>Dieses Produkt enthält eine Lichtquelle der Energieeffizienzklasse G</p>		<b>240</b>
<p>Spiegelschrank-Unterbaubeleuchtung LED 6000 K, 5,3 W, 396 Lumen, EEK G (für Spiegelschrank ab 120 cm Breite) <b>inkl.</b> Verteiler und Konverter, nur für Spie- gelschränke mit der Aufbauleuchte DE60 in den Programmen 3400 und 3980. <b>Montage im Werk an der unteren Spiegelschrankrückwand; indirekte Beleuchtung für Waschtisch (nur ohne Regal möglich).</b></p> <p><i>base lighting for mirror cabinet LED 6000 K, 5,3 W, 396 lumen EEC G (for mirror cabinet ex 120 cm width) incl. distributor and converter, only for mirror cabinets with LED top light DE60 in programmes 3400 and 3980. Factory mounting on lower mirror cabinet rear wall; indirect lighting for washbasin (only possible without shelf).</i></p>	110,0			<p><b>WTB1 10VK</b></p> <p></p> <p>3400,3980</p> <p>Dieses Produkt enthält eine Lichtquelle der Energieeffizienzklasse G</p>		<b>392</b>

EEK/EEC=Energieeffizienzklasse/energy efficiency category





Leuchtmittel sind nicht austauschbar / illuminants are not interchangeable.





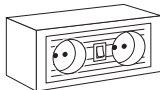

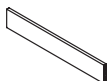
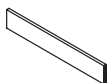
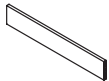
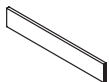
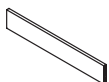

Beschreibung Description	Maße in cm Dimensions in cm			Artikel-Nr. Article no.	Türanschlag Door stop	Identnummer ID number
	B/W	H	T/D			
 <p>LED-Unterbauleuchte (2er Set) 4000 K, 6,0 W, 300 Lumen, EEK G <b>Beleuchtung kann unter Spiegelschränken und unter Regalen verbaut werden.</b></p> <p><i>LED base lighting (2 pcs / unit) 4000 K, 6,0 W, 300 lumen, EEC G <b>Lighting can be installed under mirror cabinets and under shelves.</b></i></p>	10,0		10,0	<b>WTBF210</b>		<b>439</b>
 <p>Waschtischunterschrankbeleuchtung 4000 oder 6000 K, 3,5 W, 350 Lumen, EEK F <b>Bei Anschluss kann die Lichtfarbe gewählt werden</b> <b>inkl. separatem Bewegungssensor, feste Einstellung 110 °, 1,5 mtr., 45 Sek.</b> für Unterschränke, Regale und Spiegelschränke ab 60 cm Breite; <b>Selbstmontage</b></p> <p><i>base lighting for washbasin cabinet 4000 or 6000 K, 3,5 W, 350 lumen, EEC F <b>The light colour can be selected when connected</b> <b>incl. separate motion sensor fixed setting 110 °, 1,5 mtr., 45 sec.</b> for base cabinets, shelves and mirror cabinets ex 60 cm width; <b>self-assembly</b></i></p>	57,0	2,0	1,5	<b>WTBPB60</b>		<b>370</b>
 <p>Schalter 230 Volt für Beleuchtung am Waschtischunterschrank anstelle des Bewegungssensors</p> <p><i>Switch 230 Volt for lighting on washbasin base cabinet instead of the motion sensor</i></p>				<b>SCHALTERWT</b>		<b>88</b>

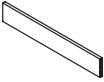
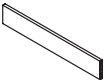
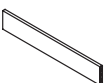
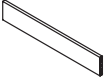
EEK/EEC=Energieeffizienzklasse/energy efficiency category

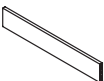
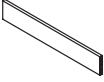



Leuchtmittel sind nicht austauschbar / illuminants are not interchangeable.

Beschreibung Description	Maße in cm Dimensions in cm			Artikel-Nr. Article no.	Türanschlag Door stop	Identnummer ID number
	B/W	H	T/D			
 <p>Doppelsteckdose, silbergrau mit Kontrolllampe (bei Schränken unter 21 cm Breite erfolgt die Montage senkrecht)</p> <p><i>double socket, silver grey with control lamp (in cabinets less than 21 cm width the socket is fitted vertically)</i></p>	16,0	6,6	7,0	<b>DSD-4</b>		<b>139</b>
 <p>Steckdose/Powerbox für Spiegelschränke Ausführung <b>Schweiz</b> IP44 mit USB-C Stecker</p> <p><i>Power socket for mirror cabinets Switzerland type IP44 with USB-C plug</i></p>				<b>Mehrpreis extra charge</b>		<b>138</b>
 <p>Steckdose/Powerbox für Spiegelschränke Ausführung <b>Frankreich</b> mit USB-C Stecker</p> <p><i>Power socket for mirror cabinets France type with USB-C plug</i></p>				<b>Mehrpreis extra charge</b>		<b>138</b>
 <p>Innenschubkasten für Beistellschränke 40 cm</p> <p><i>internal drawer for side cabinets 40 cm</i></p>	36,0	8,9	30,0	<b>ISG40</b>		<b>387</b>
 <p>Innenschublade für 60 cm Auszug</p> <p><i>internal drawer for 60 cm pull-out</i></p>				<b>ISG60</b>		<b>452</b>
 <p>Inneneinteilung passend für alle 40 cm breiten Auszüge</p> <p><i>internal subdivision suitable for all 40 cm wide pull-outs</i></p>	38,0	6,0	1,1	<b>IEG40</b>		<b>123</b>
 <p>Inneneinteilung nur passend für 60 cm Auszug des WMCAAR6 in Programm 3040</p> <p><i>internal partitioning only suitable for 60 cm pull-out of WMCAAR6 in programme 3040</i></p>	58,0	6,0	1,1	<b>IEG58</b> 3040		<b>130</b>
 <p>Inneneinteilung für 60 cm Auszüge in Programmen</p> <p><i>internal partitioning for 60 cm pull-outs in programmes</i></p>	58,0	6,0	1,1	<b>IEG60</b> 3040/3060/3090 3100/3130/3250 3260/3280/3460		<b>130</b>
 <p>Inneneinteilung für 75 cm Auszüge in Programm 3400</p> <p><i>internal partitioning for 75 cm pull-outs in programme 3400</i></p>	73,0	6,0	1,1	<b>IEG75</b> 3400		<b>139</b>
 <p>Inneneinteilung für 77 cm Auszüge in Programmen</p> <p><i>internal partitioning for 77 cm pull-outs in programmes</i></p>	75,0	6,0	1,1	<b>IEG77</b> 3260/3290/3360/3390		<b>143</b>

Beschreibung Description	Maße in cm Dimensions in cm			Artikel-Nr. Article no.	Türanschlag Door stop	Identnummer ID number
	B/W	H	T/D			
 <p>Inneneinteilung für 80 cm Auszüge in Programmen <i>internal partitioning for 80 cm pull-outs in programmes</i></p>	78,0	6,0	1,1	<b>IEG80</b> 3060/3130/3250		<b>148</b>
 <p>Inneneinteilung für 90 cm Auszüge in Programmen <i>internal partitioning for 90 cm pull-outs in programmes</i></p>	88,0	6,0	1,1	<b>IEG90</b> 3040/3060/3100/3160		<b>157</b>
 <p>Inneneinteilung für 95 cm Auszüge in Programm 3400 <i>internal partitioning for 95 cm pull-outs in programme 3400</i></p>	93,0	6,0	1,1	<b>IEG95</b> 3400		<b>162</b>
 <p>Inneneinteilung für 97 cm Auszüge in Programmen <i>internal partitioning for 97 cm pull-outs in programmes</i></p>	95,0	6,0	1,1	<b>IEG97</b> 3260/3290/3360/3390		<b>166</b>
 <p>Inneneinteilung für 100 cm Auszüge in Programmen <i>internal partitioning for 100 cm pull-outs in programmes</i></p>	98,0	6,0	1,1	<b>IEG100</b> 3130/3250		<b>171</b>
 <p>Inneneinteilung für 117 cm Auszüge in Programmen <i>internal partitioning for 117 cm pull-outs in programmes</i></p>	115,0	6,0	1,1	<b>IEG117</b> 3260/3290/3360/3390		<b>194</b>
 <p>Inneneinteilung für 120 cm Auszüge in Programmen <i>internal partitioning for 120 cm pull-outs in programmes</i></p>	118,0	6,0	1,1	<b>IEG120</b> 3040/3100		<b>199</b>
 <p>Schubkasteneinsatz (Kunststoff) für Schubkasten B: 40 cm / T: 30 cm für Beistellschränke <i>drawer insert part (plastic) for drawer 40 cm w: 40cm / d: 30 cm for side cabinets</i></p>	30,9	4,5	28,0	<b>SEG4</b>		<b>76</b>
 <p>Schubkasteneinsatz (Kunststoff) für Schubkasten B: 40 cm / T: 40 cm in Programmen <i>drawer insert part (plastic) for drawer 40 cm w: 40cm / d: 40 cm in programmes</i></p>	30,9	4,5	38,0	<b>SEG44</b> 3260/3290/3360/3390		<b>85</b>
 <p>Schubkasteneinsatz (Kunststoff) für Schubkasten B: 60 cm / T: 30 cm für Beistellschränke <i>drawer insert part (plastic) for drawer 60 cm w: 60cm / d: 30 cm for side cabinets</i></p>	50,9	4,5	28,0	<b>SEG6</b>		<b>130</b>

Beschreibung Description	Maße in cm Dimensions in cm			Artikel-Nr. Article no.	Türanschlag Door stop	Identnummer ID number
	B/W	H	T/D			
 <p>Sockelfuß 4 x 4 cm silbergrau, Höhenausgleich bis 2 cm <b>2 Stück</b></p> <p><i>base foot 4 x 4 cm silver-grey, height adjustment up to 2 cm, 2 pieces</i></p>	4,0	12,0/ 14,0	4,0	<b>SPE12</b>		<b>139</b>
 <p>Stellfuß verchromt 5x5 cm, <b>4 Stück</b> Höhenverstellung +1 cm für Schrankhöhe 47,8 cm</p> <p><i>adjustable feet chromed 5x5 cm, 4 pieces, adjustment range +1 cm for cabinet height 47,8 cm</i></p>	5,0	24,2	5,0	<b>SFA4</b>		<b>171</b>
 <p>Stellfuß verchromt 5x5 cm, <b>4 Stück</b> Höhenverstellung +1 cm für Schrankhöhe 60,6 cm</p> <p><i>adjustable feet chromed 5x5 cm, 4 pieces, adjustment range +1 cm for cabinet height 60,6 cm</i></p>	5,0	10,0	5,0	<b>SFB4</b>		<b>125</b>
 <p>Spiegelheizung für Spiegelpaneel 35 W inkl. Schalter</p> <p><i>mirror heater for mirror panel 35 W incl. switch</i></p>	50,0	30,0		<b>SH</b>		<b>415</b>
 <p>Designsiphon</p> <p><i>design siphon</i></p>				<b>DS</b>		<b>236</b>
 <p>Raumsparsiphon</p> <p><i>basin siphon</i></p>				<b>RSPAR-4</b>		<b>109</b>
 <p>Raumsparsiphon</p> <p><i>basin siphon</i></p>				<b>RSS</b>		<b>134</b>
 <p>Clou-Überlauf-System <b>chrom Glanz</b>, Wasserstauen bei Waschtischen mit Permanentablauf</p> <p><i>Clou overflow system, <b>bright chrome</b>, to retain water in basins with permanent drain valve</i></p>				<b>CLOU-4</b>		<b>208</b>
 <p>Befestigungsmaterial für Keramik- und Mineralmarmor Waschtische M10 (Bei unseren Waschtischen im Lieferumfang bereits enthalten!)</p> <p><i>Mounting set for ceramic and mineral marble washbasins M10 (Already included with our washbasins!)</i></p>				<b>MONK-4</b>		<b>66</b>
 <p>Montageschiene inkl. Befestigungsmaterial</p> <p><i>mounting rail incl. fastening material</i></p>	210,0			<b>MS210</b>		<b>102</b>

Beschreibung Description	Maße in cm Dimensions in cm			Artikel-Nr. Article no.	Türanschlag Door stop	Identnummer ID number
	B/W	H	T/D			

	Einhebel-Waschtischarmatur <b>schwarz</b> inkl. Befestigungsmaterial und „Push to open“-Ablauf (Nicht kompatibel mit CLOU-System!)  <i>single lever top, <b>black</b> incl. fittings and „push to open“ drain (Not compatible with CLOU system!)</i>				<b>MBSD</b>	<b>439</b>
	Einhebel-Waschtischarmatur chrom inkl. Zugstange und Befestigungsmaterial  <i>single lever tap, chrome incl. pull rod and fittings</i>				<b>MBCAP</b>	<b>208</b>
	Einhebel-Waschtischarmatur chrom inkl. Zugstange und Befestigungsmaterial  <i>single lever tap, chrome incl. pull rod and fittings</i>				<b>MBCA</b>	<b>439</b>
	Einhebel-Waschtischarmatur chrom inkl. Zugstange und Befestigungsmaterial  <i>single lever tap, chrome incl. pull rod and fittings</i>				<b>MBCR</b>	<b>530</b>
	Einhebel-Waschtischarmatur chrom inkl. Zugstange und Befestigungsmaterial  <i>single lever top, chrome incl. pull rod and fittings</i>				<b>MBCW</b>	<b>946</b>





# 3980spiegel

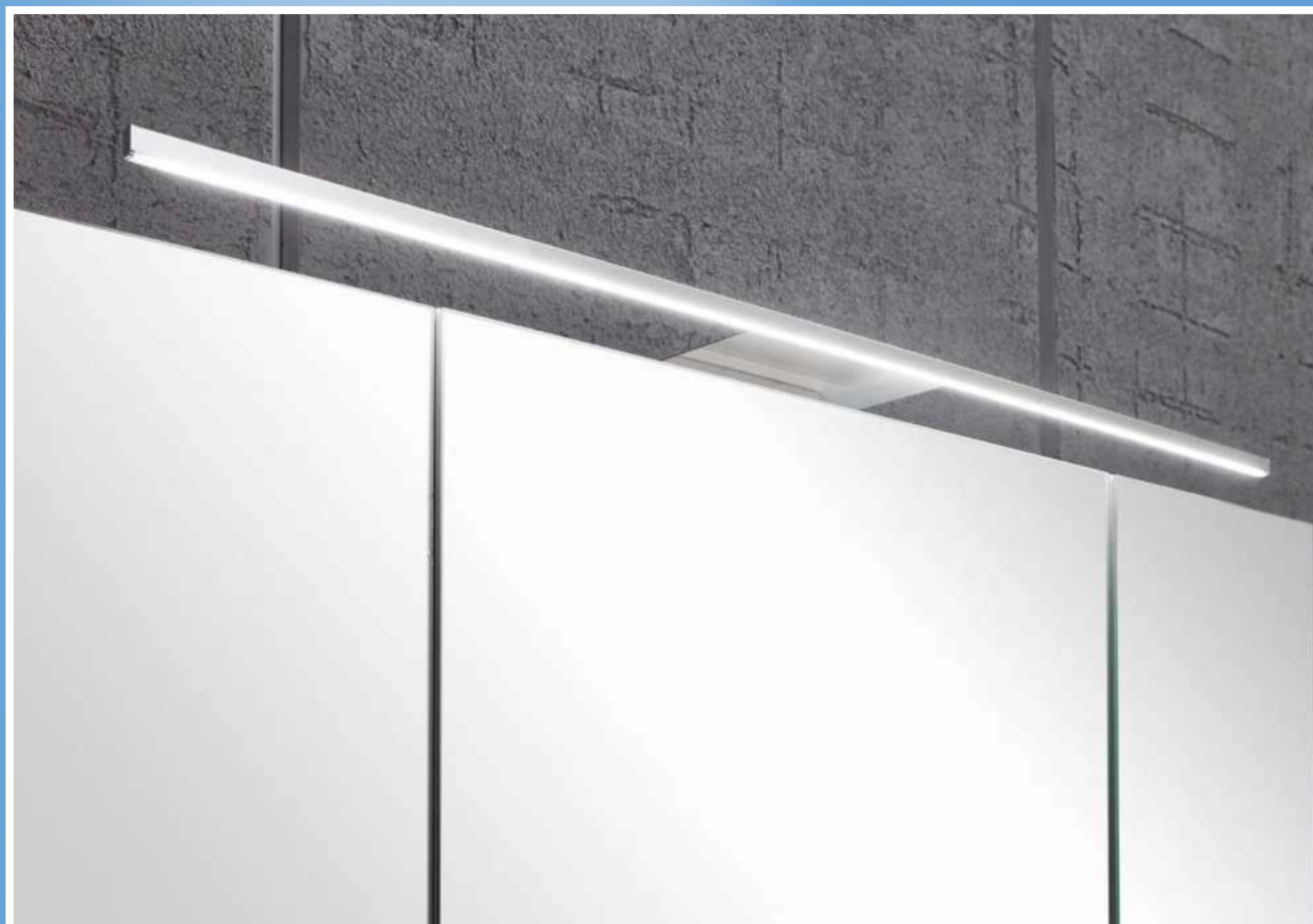
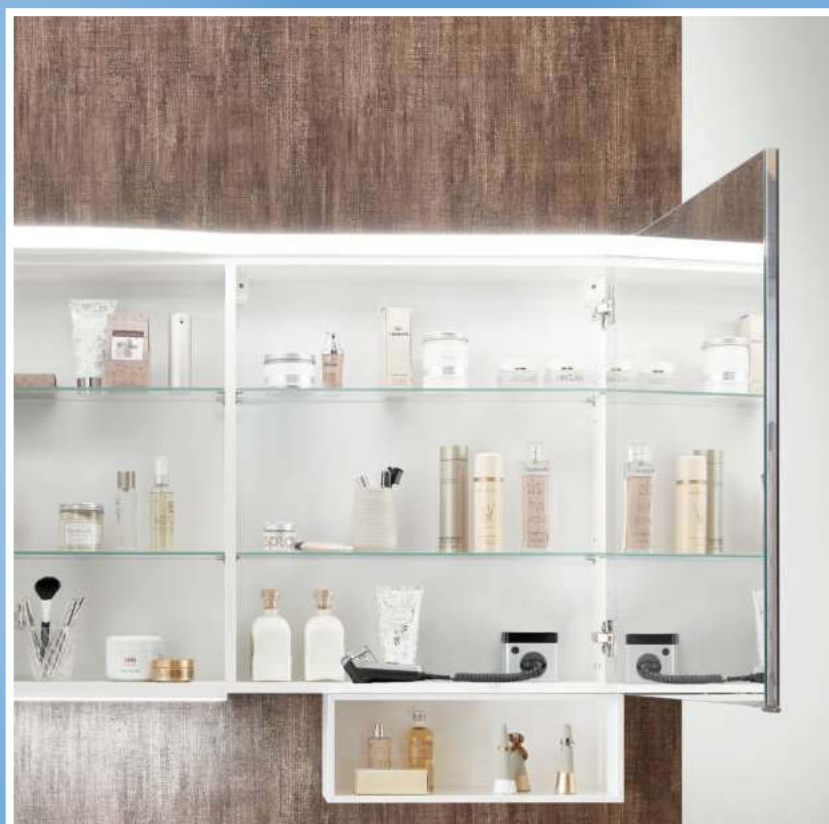





# »3980spiegel« Farb-Varianten/colour options

## Piktogramme/pictograms



LED Lichtfarbe kalt  
LED colour temperature cold



LED Lichtfarbe warm  
LED colour temperature warm



LED Lichtfarbe regelbar,  
Helligkeit dimmbar  
LED colour temperature adjust-  
able, brightness dimmable

## Schränke/cabinets 3980spiegel

### Korpusfarben/basic shell colours



**286**  
**Weiß Seidenglanz**  
Silk Gloss White  
SP86



**284**  
**Anthrazit Seidenglanz**  
Silk Gloss Anthracite  
SP84



**490**  
**Kastanie Graphit Nachbildung**  
Graphite Chestnut Finish  
SP45



**473**  
**Eiche Struktur Natur Nachbildung** **NEW**  
Oak Structure Nature Finish  
SP55



**435**  
**Eiche Struktur Weiß Nachbildung** **NEW**  
Oak Structure White Finish  
SP40



**426**  
**Eiche Struktur Braun Nachbildung** **NEW**  
Oak Structure Brown Finish  
SP70



**042**  
**Weiß Glanz Folie**  
Gloss White  
SP50



**438**  
**Anthrazit Glanz Folie**  
Gloss Anthracite  
SP30

## Spiegelschränke mit vollflächig verspiegelten Türen Mirror cabinets with full mirrored doors



**Die Steckdose / Powerbox ist immer rechts unten im Spiegelschrank verbaut, Schutzart IP21.**  
The power socket is always installed bottom right in mirror cases, type IP21.

## Spiegelschränke mit Doppelglasspiegeltüren Mirror cabinets with double glass mirror doors



**Die Steckdose / Powerbox ist immer rechts unten im Spiegelschrank verbaut, Schutzart IP21.**  
The power socket is always installed bottom right in mirror cases, type IP21.

**Die Steckdose / Powerbox für Spiegelschränke ist auch in Ausführung für die Schweiz / Frankreich erhältlich. Bitte Mehrpreis beachten (siehe Seite 13).**  
The power socket for mirror cabinets is also available for Switzerland / France. Please note extra charge (see page 13).

# »3980spiegel« Konzept/concept

## Spiegel / mirror

## Beleuchtung / lighting

60 - 80 cm Breite  
60 - 80 cm width

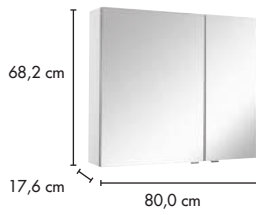

Spiegelschrank/  
mirror cabinet  
Abb. SOX8L

Artikel article	Ausführung model	Breite x Höhe x Tiefe width x height x depth
SOX6L	2-türig/doors	40/20
SOX6R	2-türig/doors	20/40
SOX7L	2-türig/doors	50/20
SOX7R	2-türig/doors	20/50
SOX8L	2-türig/doors	50/30
SOX8R	2-türig/doors	30/50

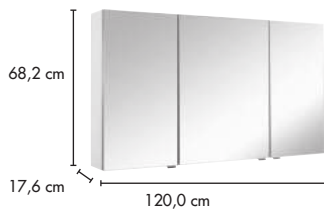

Spiegelschrank/  
mirror cabinet  
Abb. SOX12C

Artikel article	Ausführung model	Breite x Höhe x Tiefe width x height x depth
SOX9	3-türig/doors	20/50/20
SOX10	3-türig/doors	25/50/25
SOX12	3-türig/doors	35/50/35
SOX12D	3-türig/doors	60/60
SOX13	3-türig/doors	40/50/40
SOX13D	3-türig/doors	50/30/50
SOX14	3-türig/doors	40/60/40
SOX14D	3-türig/doors	50/40/50
SOX16	3-türig/doors	60/40/60

90 - 160 cm Breite  
90 - 160 cm width

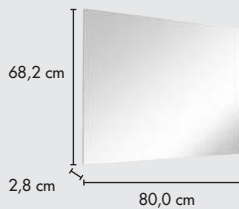

Spiegelpaneel/  
mirror panel  
Abb. SPOX8

Artikel article	Ausführung model	Breite x Höhe x Tiefe width x height x depth
SPOX6		60,0 x 68,2 x 2,8 cm
SPOX7		70,0 x 68,2 x 2,8 cm
SPOX8		80,0 x 68,2 x 2,8 cm

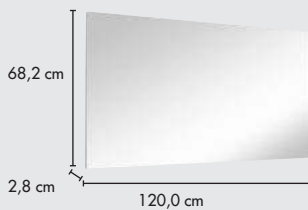

Spiegelpaneel/  
mirror panel  
Abb. SPOX12

Artikel article	Ausführung model	Breite x Höhe x Tiefe width x height x depth
SPOX9		90,0 x 68,2 x 2,8 cm
SPOX10		100,0 x 68,2 x 2,8 cm
SPOX12		120,0 x 68,2 x 2,8 cm
SPOX13		130,0 x 68,2 x 2,8 cm
SPOX14		140,0 x 68,2 x 2,8 cm
SPOX16		160,0 x 68,2 x 2,8 cm

60 - 80 cm Breite  
60 - 80 cm width

90 - 160 cm Breite  
90 - 160 cm width



FLL60



FLS60



Artikel article	Ausführung model	Lichtfarbe luminous colour	Breite width
FLL60	LED-Aufbauleuchte LED-lighting	6000 K	60,0 cm

Artikel article	Ausführung model	Lichtfarbe luminous colour	Breite width
FLS60	LED-Aufbauleuchte LED-lighting	2800-6500 K	60,0 cm



FLL90



FLS90



Artikel article	Ausführung model	Lichtfarbe luminous colour	Breite width
FLL90	LED-Aufbauleuchte LED-lighting	6000 K	90,0 cm

Artikel article	Ausführung model	Lichtfarbe luminous colour	Breite width
FLS90	LED-Aufbauleuchte LED-lighting	2800-6500 K	90,0 cm

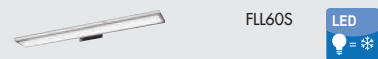

FLL60S

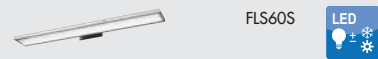

FLS60S



Artikel article	Ausführung model	Lichtfarbe luminous colour	Breite width
FLL60S	LED-Aufbauleuchte LED-lighting	6000 K	60,0 cm

Artikel article	Ausführung model	Lichtfarbe luminous colour	Breite width
FLS60S	LED-Aufbauleuchte LED-lighting	2800-6500 K	60,0 cm



FLL90S



FLS90S



Artikel article	Ausführung model	Lichtfarbe luminous colour	Breite width
FLL90S	LED-Aufbauleuchte LED-lighting	6000 K	90,0 cm

Artikel article	Ausführung model	Lichtfarbe luminous colour	Breite width
FLS90S	LED-Aufbauleuchte LED-lighting	2800-6500 K	90,0 cm

# 3980spiegel »Spiegelschränke beidseitig verspiegelt/mirror cabinets mirrored on both sides«

Beschreibung Description	Maße in cm Dimensions in cm			Artikel-Nr. Article no.	Türanschlag Door stop	Identnummer ID number
	B/W	H	T/D			

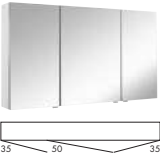
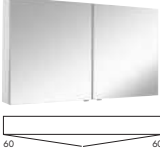
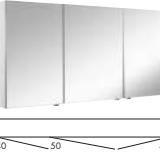
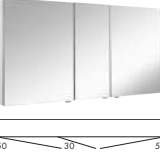
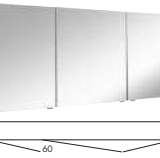
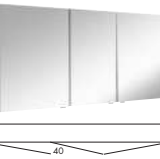
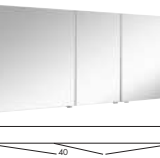

 <p>Spiegelschrank, 2 beidseitig verspiegelte Türen, 2 Glaseinlegeböden, inkl. Schalter/Steckdose</p> <p><i>mirror cabinet, 2 doors mirrored on both sides, 2 glass boards, incl. switch/socket</i></p>	60,0	68,2	17,6	<b>SOX6L</b>		1200
 <p>Spiegelschrank, 2 beidseitig verspiegelte Türen, 2 Glaseinlegeböden, inkl. Schalter/Steckdose</p> <p><i>mirror cabinet, 2 doors mirrored on both sides, 2 glass boards, incl. switch/socket</i></p>	60,0	68,2	17,6	<b>SOX6R</b>		1200
 <p>Spiegelschrank, 2 beidseitig verspiegelte Türen, 2 Glaseinlegeböden, inkl. Schalter/Steckdose</p> <p><i>mirror cabinet, 2 doors mirrored on both sides, 2 glass boards, incl. switch/socket</i></p>	70,0	68,2	17,6	<b>SOX7L</b>		1269
 <p>Spiegelschrank, 2 beidseitig verspiegelte Türen, 2 Glaseinlegeböden, inkl. Schalter/Steckdose</p> <p><i>mirror cabinet, 2 doors mirrored on both sides, 2 glass boards, incl. switch/socket</i></p>	70,0	68,2	17,6	<b>SOX7R</b>		1269
 <p>Spiegelschrank, 2 beidseitig verspiegelte Türen, 2 Glaseinlegeböden, inkl. Schalter/Steckdose</p> <p><i>mirror cabinet, 2 doors mirrored on both sides, 2 glass boards, incl. switch/socket</i></p>	80,0	68,2	17,6	<b>SOX8L</b>		1338
 <p>Spiegelschrank, 2 beidseitig verspiegelte Türen, 2 Glaseinlegeböden, inkl. Schalter/Steckdose</p> <p><i>mirror cabinet, 2 doors mirrored on both sides, 2 glass boards, incl. switch/socket</i></p>	80,0	68,2	17,6	<b>SOX8R</b>		1338
 <p>Spiegelschrank, 3 beidseitig verspiegelte Türen, 4 Glaseinlegeböden, inkl. Schalter/Steckdose</p> <p><i>mirror cabinet, 3 doors mirrored on both sides, 4 glass boards, incl. switch/socket</i></p>	90,0	68,2	17,6	<b>SOX9</b>		1546
 <p>Spiegelschrank, 3 beidseitig verspiegelte Türen, 4 Glaseinlegeböden, inkl. Schalter/Steckdose</p> <p><i>mirror cabinet, 3 doors mirrored on both sides, 4 glass boards, incl. switch/socket</i></p>	100,0	68,2	17,6	<b>SOX10</b>		1638

# 3980spiegel »Spiegelschränke beidseitig verspiegelt/mirror cabinets mirrored on both sides«

Beschreibung Description	Maße in cm Dimensions in cm			Artikel-Nr. Article no.	Türanschlag Door stop	Identnummer ID number
	B/W	H	T/D			
 <p>Spiegelschrank, 3 beidseitig verspiegelte Türen, 4 Glaseinlegeböden, inkl. Schalter/Steckdose</p> <p><i>mirror cabinet, 3 doors mirrored on both sides, 4 glass boards, incl. switch/socket</i></p>	120	68,2	17,6	<b>SOX12</b>		<b>1730</b>
 <p>Spiegelschrank, 2 beidseitig verspiegelte Türen, 4 Glaseinlegeböden, inkl. Schalter/Steckdose</p> <p><i>mirror cabinet, 2 doors mirrored on both sides, 4 glass boards, incl. switch/socket</i></p>	120	68,2	17,6	<b>SOX12D</b>		<b>1661</b>
 <p>Spiegelschrank, 3 beidseitig verspiegelte Türen, 4 Glaseinlegeböden, inkl. Schalter/Steckdose</p> <p><i>mirror cabinet, 3 doors mirrored on both sides, 4 glass boards, incl. switch/socket</i></p>	130	68,2	17,6	<b>SOX13</b>		<b>1846</b>
 <p>Spiegelschrank, 3 beidseitig verspiegelte Türen, 4 Glaseinlegeböden, inkl. Schalter/Steckdose</p> <p><i>mirror cabinet, 3 doors mirrored on both sides, 4 glass boards, incl. switch/socket</i></p>	130	68,2	17,6	<b>SOX13D</b>		<b>1846</b>
 <p>Spiegelschrank, 3 beidseitig verspiegelte Türen, 4 Glaseinlegeböden, inkl. Schalter/Steckdose</p> <p><i>mirror cabinet, 3 doors mirrored on both sides, 4 glass boards, incl. switch/socket</i></p>	140	68,2	17,6	<b>SOX14</b>		<b>1961</b>
 <p>Spiegelschrank, 3 beidseitig verspiegelte Türen, 4 Glaseinlegeböden, inkl. Schalter/Steckdose</p> <p><i>mirror cabinet, 3 doors mirrored on both sides, 4 glass boards, incl. switch/socket</i></p>	140	68,2	17,6	<b>SOX14D</b>		<b>1961</b>
 <p>Spiegelschrank, 3 beidseitig verspiegelte Türen, 4 Glaseinlegeböden, inkl. Schalter/Steckdose</p> <p><i>mirror cabinet, 3 doors mirrored on both sides, 4 glass boards, incl. switch/socket</i></p>	160	68,2	17,6	<b>SOX16</b>		<b>2123</b>

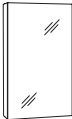
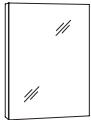
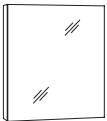
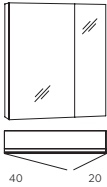
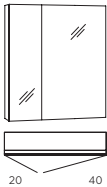
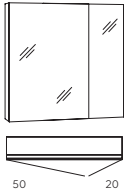
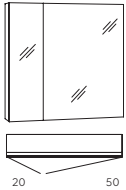
Beschreibung Description	Maße in cm Dimensions in cm			Artikel-Nr. Article no.	Türanschlag Door stop	Identnummer ID number
	B/W	H	T/D			

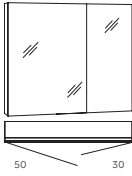
 <p>Spiegelschrank, ohne Beleuchtung, 1 Doppelglasspiegeltür, 2 Glaseinlegeböden, inkl. Schalter/Steckdose</p> <p><i>mirror cabinet, without lighting, 1 double glass mirror door, 2 glass boards, incl. switch/socket</i></p>	40,0	68,2	13,6	<b>SOXD4</b>	L/R	<b>1246</b>
 <p>Spiegelschrank, ohne Beleuchtung, 1 Doppelglasspiegeltür, 2 Glaseinlegeböden, inkl. Schalter/Steckdose</p> <p><i>mirror cabinet, without lighting, 1 double glass mirror door, 2 glass boards , incl. switch/socket</i></p>	50,0	68,2	13,6	<b>SOXD5</b>	L/R	<b>1431</b>
 <p>Spiegelschrank, ohne Beleuchtung, 1 Doppelglasspiegeltür, 2 Glaseinlegeböden, inkl. Schalter/Steckdose</p> <p><i>mirror cabinet, without lighting, 1 double glass mirror door, 2 glass boards, incl. switch/socket</i></p>	60,0	68,2	13,6	<b>SOXD6</b>	L/R	<b>1476</b>
 <p>Spiegelschrank, ohne Beleuchtung, 2 Doppelglasspiegeltüren, 2 Glaseinlegeböden, inkl. Schalter/Steckdose</p> <p><i>mirror cabinet, without lighting, 2 double glass mirror doors, 2 glass boards, incl. switch/socket</i></p>	60,0	68,2	13,6	<b>SOXD6L</b>		<b>1684</b>
 <p>Spiegelschrank, ohne Beleuchtung, 2 Doppelglasspiegeltüren, 2 Glaseinlegeböden, inkl. Schalter/Steckdose</p> <p><i>mirror cabinet, without lighting, 2 double glass mirror doors, 2 glass boards, incl. switch/socket</i></p>	60,0	68,2	13,6	<b>SOXD6R</b>		<b>1684</b>
 <p>Spiegelschrank, ohne Beleuchtung, 2 Doppelglasspiegeltüren, 2 Glaseinlegeböden, inkl. Schalter/Steckdose</p> <p><i>mirror cabinet, without lighting, 2 double glass mirror doors, 2 glass boards, incl. switch/socket</i></p>	70,0	68,2	13,6	<b>SOXD7L</b>		<b>1799</b>
 <p>Spiegelschrank, ohne Beleuchtung, 2 Doppelglasspiegeltüren, 2 Glaseinlegeböden, inkl. Schalter/Steckdose</p> <p><i>mirror cabinet, without lighting, 2 double glass mirror doors, 2 glass boards, incl. switch/socket</i></p>	70,0	68,2	13,6	<b>SOXD7R</b>		<b>1799</b>

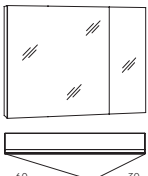
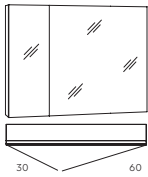
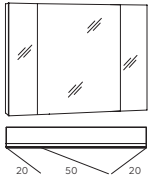
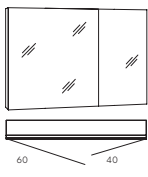
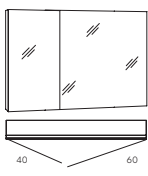
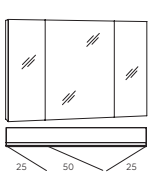
Beschreibung Description	Maße in cm Dimensions in cm			Artikel-Nr. Article no.	Türanschlag Door stop	Identnummer ID number
	B/W	H	T/D			
 <p>Spiegelschrank, ohne Beleuchtung, 2 Doppelglasspiegeltüren, 2 Glaseinlegeböden, inkl. Schalter/Steckdose</p> <p><i>mirror cabinet, without lighting, 2 double glass mirror doors, 2 glass boards, incl. switch/socket</i></p>	80,0	68,2	13,6	<b>SOXD8L</b>		<b>1868</b>
 <p>Spiegelschrank, ohne Beleuchtung, 2 Doppelglasspiegeltüren, 2 Glaseinlegeböden, inkl. Schalter/Steckdose</p> <p><i>mirror cabinet, without lighting, 2 double glass mirror doors, 2 glass boards, incl. switch/socket</i></p>	80,0	68,2	13,6	<b>SOXD8R</b>		<b>1868</b>
 <p>Spiegelschrank, ohne Beleuchtung, 2 Doppelglasspiegeltüren, 2 Glaseinlegeböden, inkl. Schalter/Steckdose</p> <p><i>mirror cabinet, without lighting, 2 double glass mirror doors, 2 glass boards, incl. switch/socket</i></p>	90,0	68,2	13,6	<b>SOXD9L</b>		<b>1892</b>
 <p>Spiegelschrank, ohne Beleuchtung, 2 Doppelglasspiegeltüren, 2 Glaseinlegeböden, inkl. Schalter/Steckdose</p> <p><i>mirror cabinet, without lighting, 2 double glass mirror doors, 2 glass boards, incl. switch/socket</i></p>	90,0	68,2	13,6	<b>SOXD9R</b>		<b>1892</b>
 <p>Spiegelschrank, ohne Beleuchtung, 3 Doppelglasspiegeltüren, 4 Glaseinlegeböden, inkl. Schalter/Steckdose</p> <p><i>mirror cabinet, without lighting, 3 double glass mirror doors, 4 glass boards, incl. switch/socket</i></p>	90,0	68,2	13,6	<b>SOXD9</b>		<b>2353</b>
 <p>Spiegelschrank, ohne Beleuchtung, 2 Doppelglasspiegeltüren, 2 Glaseinlegeböden, inkl. Schalter/Steckdose</p> <p><i>mirror cabinet, without lighting, 2 double glass mirror doors, 2 glass boards, incl. switch/socket</i></p>	100,0	68,2	13,6	<b>SOXD10L</b>		<b>1937</b>
 <p>Spiegelschrank, ohne Beleuchtung, 2 Doppelglasspiegeltüren, 2 Glaseinlegeböden, inkl. Schalter/Steckdose</p> <p><i>mirror cabinet, without lighting, 2 double glass mirror doors, 2 glass boards, incl. switch/socket</i></p>	100,0	68,2	13,6	<b>SOXD10R</b>		<b>1937</b>
 <p>Spiegelschrank, ohne Beleuchtung, 3 Doppelglasspiegeltüren, 4 Glaseinlegeböden, inkl. Schalter/Steckdose</p> <p><i>mirror cabinet, without lighting, 3 double glass mirror doors, 4 glass boards, incl. switch/socket</i></p>	100,0	68,2	13,6	<b>SOXD10</b>		<b>2399</b>

Beschreibung Description	Maße in cm Dimensions in cm			Artikel-Nr. Article no.	Türanschlag Door stop	Identnummer ID number
	B/W	H	T/D			

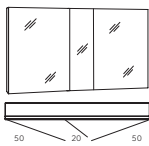
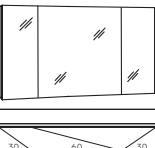
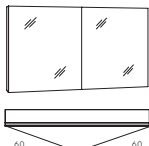
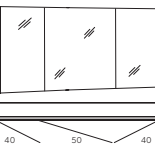
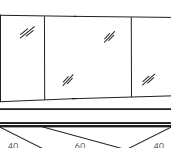
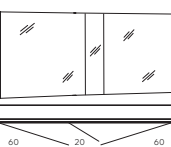
 <p>Spiegelschrank, ohne Beleuchtung, 3 Doppelglasspiegeltüren, 4 Glaseinlegeböden, inkl. Schalter/Steckdose</p> <p><i>mirror cabinet, without lighting, 3 double glass mirror doors, 4 glass boards, incl. switch/socket</i></p>	120,0	68,2	13,6	<b>SOXD12M</b>		<b>2445</b>
 <p>Spiegelschrank, ohne Beleuchtung, 3 Doppelglasspiegeltüren, 4 Glaseinlegeböden, inkl. Schalter/Steckdose</p> <p><i>mirror cabinet, without lighting, 3 double glass mirror doors, 4 glass boards, incl. switch/socket</i></p>	120,0	68,2	13,6	<b>SOXD12</b>		<b>2445</b>
 <p>Spiegelschrank, ohne Beleuchtung, 2 Doppelglasspiegeltüren, 4 Glaseinlegeböden, inkl. Schalter/Steckdose</p> <p><i>mirror cabinet, without lighting, 2 double glass mirror doors, 4 glass boards, incl. switch/socket</i></p>	120,0	68,2	13,6	<b>SOXD12D</b>		<b>2053</b>
 <p>Spiegelschrank, ohne Beleuchtung, 3 Doppelglasspiegeltüren, 4 Glaseinlegeböden, inkl. Schalter/Steckdose</p> <p><i>mirror cabinet, without lighting, 3 double glass mirror doors, 4 glass boards, incl. switch/socket</i></p>	130,0	68,2	13,6	<b>SOXD13</b>		<b>2492</b>
 <p>Spiegelschrank, ohne Beleuchtung, 3 Doppelglasspiegeltüren, 4 Glaseinlegeböden, inkl. Schalter/Steckdose</p> <p><i>mirror cabinet, without lighting, 3 double glass mirror doors, 4 glass boards, incl. switch/socket</i></p>	140,0	68,2	13,6	<b>SOXD14</b>		<b>2583</b>
 <p>Spiegelschrank, ohne Beleuchtung, 3 Doppelglasspiegeltüren, 4 Glaseinlegeböden, inkl. Schalter/Steckdose</p> <p><i>mirror cabinet, without lighting, 3 double glass mirror doors, 4 glass boards, incl. switch/socket</i></p>	140,0	68,2	13,6	<b>SOXD14M</b>		<b>2583</b>

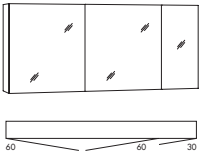
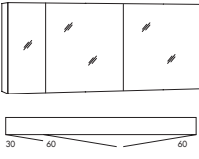
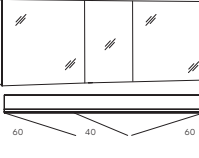
Beschreibung Description	Maße in cm Dimensions in cm			Artikel-Nr. Article no.	Türanschlag Door stop	Identnummer ID number
	B/W	H	T/D			
 <p>Spiegelschrank, ohne Beleuchtung, 3 Doppelglasspiegeltüren, 6 Glaseinlegeböden, inkl. Schalter/Steckdose</p> <p><i>mirror cabinet, without lighting, 3 double glass mirror doors, 6 glass boards, incl. switch/socket</i></p>	150,0	68,2	13,6	<b>SOXD15L</b>		<b>2722</b>
 <p>Spiegelschrank, ohne Beleuchtung, 3 Doppelglasspiegeltüren, 6 Glaseinlegeböden, inkl. Schalter/Steckdose</p> <p><i>mirror cabinet, without lighting, 3 double glass mirror doors, 6 glass boards, incl. switch/socket</i></p>	150,0	68,2	13,6	<b>SOXD15R</b>		<b>2722</b>
 <p>Spiegelschrank, ohne Beleuchtung, 3 Doppelglasspiegeltüren, 4 Glaseinlegeböden, inkl. Schalter/Steckdose</p> <p><i>mirror cabinet, without lighting, 3 double glass mirror doors, 4 glass boards, incl. switch/socket</i></p>	160,0	68,2	13,6	<b>SOXD16</b>		<b>2722</b>

















## 3980spiegel »Spiegelpaneele/mirror panels«

	Spiegelpaneel ohne Beleuchtung inkl. Schalter mittig unten für 2 Lichtfarben  <i>mirror panel without lighting incl. switch bottom center for 2 luminous colours</i>	60,0	68,2	2,8	<b>SPOX6</b>	<b>461</b>
	Spiegelpaneel ohne Beleuchtung inkl. Schalter mittig unten für 2 Lichtfarben  <i>mirror panel without lighting incl. switch bottom center for 2 luminous colours</i>	70,0	68,2	2,8	<b>SPOX7</b>	<b>508</b>
	Spiegelpaneel ohne Beleuchtung inkl. Schalter mittig unten für 2 Lichtfarben  <i>mirror panel without lighting incl. switch bottom center for 2 luminous colours</i>	80,0	68,2	2,8	<b>SPOX8</b>	<b>554</b>
	Spiegelpaneel ohne Beleuchtung inkl. Schalter mittig unten für 2 Lichtfarben  <i>mirror panel without lighting incl. switch bottom center for 2 luminous colours</i>	90,0	68,2	2,8	<b>SPOX9</b>	<b>600</b>
	Spiegelpaneel ohne Beleuchtung inkl. Schalter mittig unten für 2 Lichtfarben  <i>mirror panel without lighting incl. switch bottom center for 2 luminous colours</i>	100,0	68,2	2,8	<b>SPOX10</b>	<b>646</b>
	Spiegelpaneel ohne Beleuchtung inkl. Schalter mittig unten für 2 Lichtfarben  <i>mirror panel without lighting incl. switch bottom center for 2 luminous colours</i>	120,0	68,2	2,8	<b>SPOX12</b>	<b>692</b>
	Spiegelpaneel ohne Beleuchtung inkl. Schalter mittig unten für 2 Lichtfarben  <i>mirror panel without lighting incl. switch bottom center for 2 luminous colours</i>	130,0	68,2	2,8	<b>SPOX13</b>	<b>739</b>
	Spiegelpaneel ohne Beleuchtung inkl. Schalter mittig unten für 2 Lichtfarben  <i>mirror panel without lighting incl. switch bottom center for 2 luminous colours</i>	140,0	68,2	2,8	<b>SPOX14</b>	<b>785</b>
	Spiegelpaneel ohne Beleuchtung inkl. Schalter mittig unten für 2 Lichtfarben  <i>mirror panel without lighting incl. switch bottom center for 2 luminous colours</i>	160,0	68,2	2,8	<b>SPOX16</b>	<b>830</b>

**Aufgrund des Schalters auf der Unterseite können unter diese Spiegelpaneele keine Regale geplant werden.**  
*Due to the switch beneath the mirror no shelves can be planned below these mirror panels.*

# 3980spiegel »Beleuchtung/lighting«

Beschreibung Description	Maße in cm Dimensions in cm			Artikel-Nr. Article no.	Identnummer ID number
	B/W	H	T/D		
 <p>LED Aufbauleuchte 2800-6500 K, 12 W, 926 Lumen, EEK G</p> <p><i>LED top light 2800-6500 K, 12 W, 926 lumen, EEC G</i></p>	60,0	2,5	8,0	<b>FLS60</b> <b>FLS60S</b>  für Spiegelschränke / for mirror cabinets für Spiegelpaneele / for mirror panels	<b>808</b> <b>923</b>
 <p>LED Aufbauleuchte 2800-6500 K, 17,5 W, 1390 Lumen, EEK G</p> <p><i>LED top light 2800-6500 K, 17,5 W, 1390 lumen, EEC G</i></p>	90,0	2,5	8,0	<b>FLS90</b> <b>FLS90S</b>  für Spiegelschränke / for mirror cabinets für Spiegelpaneele / for mirror panels	<b>877</b> <b>1038</b>
 <p>LED Aufbauleuchte 6000 K, 11,5 W, 1168 Lumen, EEK E</p> <p><i>LED top light 6000 K, 11,5 W, 1168 lumen, EEC E</i></p>	60,0	2,5	8,0	<b>FLL60</b> <b>FLL60S</b>  für Spiegelschränke / for mirror cabinets für Spiegelpaneele / for mirror panels	<b>600</b> <b>715</b>
 <p>LED Aufbauleuchte 6000 K, 17,0 W, 1751 Lumen, EEK E</p> <p><i>LED top light 6000 K, 17,0 W, 1751 lumen, EEC E</i></p>	90,0	2,5	8,0	<b>FLL90</b> <b>FLL90S</b>  für Spiegelschränke / for mirror cabinets für Spiegelpaneele / for mirror panels	<b>670</b> <b>830</b>
 <p>LED Aufbauleuchte 6000 K, 4,3 W, 518 Lumen, EEK E</p> <p><i>LED top light 6000 K, 4,3 W, 518 lumen, EEC E</i></p>	54,0	5,0	5,0	<b>LL54</b> <b>LL54S</b>  für Spiegelschränke / for mirror cabinets für Spiegelpaneele / for mirror panels	<b>300</b> <b>415</b>
 <p>LED Aufbauleuchte 6000 K, 6,0 W, 720 Lumen, EEK E</p> <p><i>LED top light 6000 K, 6,0 W, 720 lumen, EEC E</i></p>	74,0	5,0	5,0	<b>LL74</b> <b>LL74S</b>  für Spiegelschränke / for mirror cabinets für Spiegelpaneele / for mirror panels	<b>323</b> <b>439</b>
 <p>LED Aufbauleuchte 6000 K, 7,4 W, 892 Lumen, EEK E</p> <p><i>LED top light 6000 K, 7,4 W, 892 lumen, EEC E</i></p>	94,0	5,0	5,0	<b>LL94</b> <b>LL94S</b>  für Spiegelschränke / for mirror cabinets für Spiegelpaneele / for mirror panels	<b>370</b> <b>485</b>













Unsere Spiegelschränke werden mit passendem Trafo geliefert. Daher enthalten nur die Beleuchtungen für Spiegelpaneele einen Trafo. Bei Bestellung einer Beleuchtung ohne MARLIN-Spiegelschrank daher bitte die Version für Spiegelpaneele wählen.

Our mirror cabinets are supplied with a matching converter. Therefore only the mirror panel lights include a separate converter. Choose the mirror panel version when ordering a top light without a MARLIN mirror cabinet.

EEK/EEC=Energieeffizienzklasse/energy efficiency category

Leuchtmittel sind nicht austauschbar / illuminants are not interchangeable.



















# 3980spiegel »Beleuchtung/lighting«

Beschreibung Description	Maße in cm Dimensions in cm			Artikel-Nr. Article no.	Identnummer ID number
	B/W	H	T/D		
 <p>LED Aufbauleuchte 6000 K, 6,3 W, 817 Lumen, EEK F</p> <p>LED top light 6000 K, 6,3 W, 817 lumen, EEK F</p>	70,0	3,5	11,0	<b>LF70</b> <b>LF70S</b>  für Spiegelschränke / for mirror cabinets für Spiegelpaneele / for mirror panels Dieses Produkt enthält eine Lichtquelle der Energieeffizienzklasse F	<b>854</b> <b>969</b>
 <p>LED Aufbauleuchte 6000 K, 9,9 W, 1284 Lumen, EEK F</p> <p>LED top light 6000 K, 9,9 W, 1284 lumen, EEK F</p>	110,0	3,5	11,0	<b>LF110</b> <b>LF110S</b>  für Spiegelschränke / for mirror cabinets für Spiegelpaneele / for mirror panels Dieses Produkt enthält eine Lichtquelle der Energieeffizienzklasse F	<b>1107</b> <b>1269</b>
 <p>LED Aufbauleuchte 6000 K, 4,8 W, 576 Lumen, EEK E</p> <p>LED top light 6000 K, 4,8 W, 576 lumen, EEK E</p>	60,0	11,5	13,0	<b>RL60</b> <b>RL60S</b>  für Spiegelschränke / for mirror cabinets für Spiegelpaneele / for mirror panels Dieses Produkt enthält eine Lichtquelle der Energieeffizienzklasse E	<b>415</b> <b>530</b>
 <p>LED Aufbauleuchte 6000 K, 12,2 W, 1020 Lumen, EEK E</p> <p>LED top light 6000 K, 12,2 W, 1020 lumen, EEK E</p>	60,0	11,5	13,0	<b>RL90</b> <b>RL90S</b>  für Spiegelschränke / for mirror cabinets für Spiegelpaneele / for mirror panels Dieses Produkt enthält eine Lichtquelle der Energieeffizienzklasse E	<b>530</b> <b>646</b>
 <p>LED Aufbauleuchte 2800-6500 K, 16,7 W, 1487 Lumen, EEK F</p> <p>LED top light 2800-6500 K, 16,7 W, 1487 lumen, EEK F</p>	60,0	1,8	17,4	<b>WI6</b> <b>WI6S</b>  für Spiegelschränke / for mirror cabinets für Spiegelpaneele / for mirror panels Dieses Produkt enthält eine Lichtquelle der Energieeffizienzklasse F	<b>623</b> <b>785</b>
 <p>LED Aufbauleuchte 2800-6500 K, 22,8 W, 2004 Lumen, EEK F</p> <p>LED top light 2800-6500 K, 22,8 W, 2004 lumen, EEK F</p>	80,0	1,8	17,4	<b>WI8</b> <b>WI8S</b>  für Spiegelschränke / for mirror cabinets für Spiegelpaneele / for mirror panels Dieses Produkt enthält eine Lichtquelle der Energieeffizienzklasse F	<b>854</b> <b>1016</b>

**Unsere Spiegelschränke werden mit passendem Trafo geliefert. Daher enthalten nur die Beleuchtungen für Spiegelpaneele einen Trafo. Bei Bestellung einer Beleuchtung ohne MARLIN-Spiegelschrank daher bitte die Version für Spiegelpaneele wählen.**  
 Our mirror cabinets are supplied with a matching converter. Therefore only the mirror panel lights include a separate converter. Choose the mirror panel version when ordering a top light without a MARLIN mirror cabinet.

EEK/EEC=Energieeffizienzklasse/energy efficiency category  
 Leuchtmittel sind nicht austauschbar / illuminants are not interchangeable.

# 3980spiegel »Beleuchtung/lighting«

Beschreibung Description	Maße in cm Dimensions in cm			Artikel-Nr. Article no.	Identnummer ID number
	B/W	H	T/D		
 <p>LED Aufbauleuchte 2800-6500 K, 5,6 W, 452 Lumen, EEK G</p> <p>LED top light 2800-6500 K, 5,6 W, 452 lumen, EEK G</p>	60,0	1,5	5,0	<b>SLM60</b> für Spiegelschränke / for mirror cabinets <b>SLM60S</b> für Spiegelpaneele / for mirror panels 	<b>300</b> <b>415</b>
				Dieses Produkt enthält eine Lichtquelle der Energieeffizienzklasse G	
 <p>LED Aufbauleuchte 2800-6500 K, 8,4 W, 688 Lumen, EEK G</p> <p>LED top light 2800-6500 K, 8,4 W, 688 lumen, EEK G</p>	90,0	1,5	5,0	<b>SLM90</b> für Spiegelschränke / for mirror cabinets <b>SLM90S</b> für Spiegelpaneele / for mirror panels 	<b>392</b> <b>508</b>
				Dieses Produkt enthält eine Lichtquelle der Energieeffizienzklasse G	
 <p>LED Aufbauleuchte 4000 K, 17,3 W, 2160 Lumen, EEK E</p> <p>LED top light 4000 K, 17,3 W, 2160 lumen, EEK E</p>	60,0	2,0	7,0	 <b>AZA60</b> für Spiegelschränke / for mirror cabinets <b>AZA60S</b> für Spiegelpaneele / for mirror panels 	<b>323</b> <b>485</b>
				Dieses Produkt enthält eine Lichtquelle der Energieeffizienzklasse E	
 <p>LED Aufbauleuchte 4000 K, 23,0 W, 2880 Lumen, EEK E</p> <p>LED top light 4000 K, 23,0 W, 2880 lumen, EEK E</p>	80,0	2,0	7,0	 <b>AZA80</b> für Spiegelschränke / for mirror cabinets <b>AZA80S</b> für Spiegelpaneele / for mirror panels 	<b>370</b> <b>530</b>
				Dieses Produkt enthält eine Lichtquelle der Energieeffizienzklasse E	
 <p>LED Aufbauleuchte 4000 K, 5,8 W, 248 Lumen, EEK F</p> <p>LED top light 4000 K, 5,8 W, 248 lumen, EEK F</p>	60,0	4,0	7,0	 <b>ASL60</b> für Spiegelschränke / for mirror cabinets <b>ASL60S</b> für Spiegelpaneele / for mirror panels 	<b>162</b> <b>300</b>
				Dieses Produkt enthält eine Lichtquelle der Energieeffizienzklasse F	
 <p>LED Aufbauleuchte 4000 K, 7,8 W, 331 Lumen, EEK F</p> <p>LED top light 4000 K, 7,8 W, 331 lumen, EEK F</p>	80,0	4,0	7,0	 <b>ASL80</b> für Spiegelschränke / for mirror cabinets <b>ASL80S</b> für Spiegelpaneele / for mirror panels 	<b>184</b> <b>323</b>
				Dieses Produkt enthält eine Lichtquelle der Energieeffizienzklasse F	
 <p>LED Aufbauleuchte 6000 K, 8,0 W, 870 Lumen, EEK F</p> <p>LED top light 6000 K, 8,0 W, 870 lumen, EEK F</p>	60,0	5,2	10,7	 <b>DE60</b> für Spiegelschränke / for mirror cabinets 	<b>184</b>
				Dieses Produkt enthält eine Lichtquelle der Energieeffizienzklasse F	

Unsere Spiegelschränke werden mit passendem Trafo geliefert. Daher enthalten nur die Beleuchtungen für Spiegelpaneele einen Trafo. Bei Bestellung einer Beleuchtung ohne MARLIN-Spiegelschrank daher bitte die Version für Spiegelpaneele wählen.



Our mirror cabinets are supplied with a matching converter. Therefore only the mirror panel lights include a separate converter. Choose the mirror panel version when ordering a top light without a MARLIN mirror cabinet.

EEK/EEC=Energieeffizienzklasse/energy efficiency category

Leuchtmittel sind nicht austauschbar / illuminants are not interchangeable.

## 3980spiegel »Zubehör/accessoires«

Beschreibung Description	Maße in cm Dimensions in cm			Artikel-Nr. Article no.	Türanschlag Door stop	Identnummer ID number
	B/W	H	T/D			

	Spiegelheizung für Spiegelpaneel 35 W inkl. Schalter  <i>mirror heater for mirror panel 35 W incl. switch</i>	50,0	30,0		<b>SH</b>	<b>415</b>
	Steckdose/Powerbox für Spiegelschränke Ausführung <b>Schweiz</b> IP44 mit USB-C Stecker  <i>Power socket for mirror cabinets Switzerland type IP44 with USB-C plug</i>				<b>Mehrpreis extra charge</b>	<b>138</b>
	Steckdose/Powerbox für Spiegelschränke Ausführung <b>Frankreich</b> mit USB-C Stecker  <i>Power socket for mirror cabinets France type with USB-C plug</i>				<b>Mehrpreis extra charge</b>	<b>138</b>

**i** Weiteres Zubehör finden Sie im Register 3970.  
*Further accessoires can be found in register 3970.*











# 3990beistellschränke







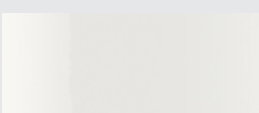

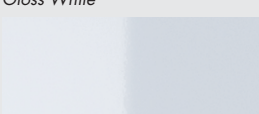
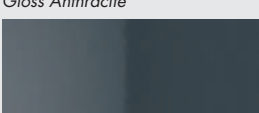









# »3990beistellschränke« Farb-Varianten/colour options

Frontfarben front colours			3020life	3040city	3060daily	3090cosmo	3100scala	3130azure	3160motion	3250star	3260fair	3280cara	3360line	3460marlinplan
<b>Kastanie Grahpit Nachbildung</b> <i>Graphite Cestnut Finish</i> 	Melamin melamine	<b>BMC_</b> 490	•		•					•	•		•	•
	Folie foil	<b>BFC_</b> 449		•		•	•	•	•			•		
<b>Eiche Struktur Natur Nachbildung</b> <i>Oak Struktore Nature Finish</i> 	Melamin melamine	<b>BMM_</b> 473	•		•					•	•		•	•
	Folie foil	<b>BFM_</b> 273		•		•	•	•	•			•		
<b>Eiche Struktur Weiß Nachbildung</b> <i>Oak Struktore White Finish</i> 	Melamin melamine	<b>BML_</b> 435	•		•					•	•		•	•
	Folie foil	<b>BFL_</b> 235		•		•	•	•	•			•		
<b>Eiche Struktur Braun Nachbildung</b> <i>Oak Struktore Brown Finish</i> 	Melamin melamine	<b>BMH_</b> 426	•		•					•	•		•	•
	Folie foil	<b>BFH_</b> 226		•		•	•	•	•			•		
<b>Weiß Seidenglanz</b> <i>Silk Gloss White</i> 	Melamin melamine	<b>BME_</b> 286	•		•				nur Kerpus only carcass	•	•		•	•
	Folie foil	nicht lieferbar not available	nicht lieferbar not available											
<b>Anthrazit Seidenglanz</b> <i>Silk Gloss Anthracite</i> 	Melamin melamine	<b>BMA_</b> 284	•		•					•	•		•	•
	Folie foil	nicht lieferbar not available	nicht lieferbar not available											
<b>Rot Glanz</b> <i>Gloss Red</i> 	Melamin melamine	nicht lieferbar not available	nicht lieferbar not available											
	Folie foil	<b>BFR_</b> 952	•	•			•	•						
<b>Weiß Glanz</b> <i>Gloss White</i> 	Melamin melamine	nicht lieferbar not available	nicht lieferbar not available											
	Folie foil	<b>BFG_</b> 961	•	•		•	•	•	•	•	•	•	•	nur Front only front
<b>Anthrazit Glanz</b> <i>Gloss Anthracite</i> 	Melamin melamine	nicht lieferbar not available	nicht lieferbar not available											
	Folie foil	<b>BFF_</b> 438	•	•		•	•	•	•	•	•	•	•	nur Front only front

# »3990beistellschränke« Griff-Varianten/handle options

Griff-Varianten handle options	Grifftyp*/ handletyp*	3020life	3040city	3060daily	3090cosmo	3100scala	3130azure	3160motion	3250star	3260fair	3280cara	3360line	3460marlinplan
	193	•	•										
	237	•					•						
	281			•									
	138				•	•		•					
	338				•								
	438				•			•			•		
	285						•						
	205						•						
	379								•				
	271								•	•		•	•
	386									•		•	•
	255												•

\* Die Angabe des Grifftyps ist ausreichend. Die Griffe werden passend zur jeweiligen Schrankbreite beigelegt.

\* The indication of the handle typ is sufficient. The handles are supplied to match the respective cabinet width.

# »3990beistellschränke« Farb-Varianten/colour options

## Schränke/cabinets 3990beistellschränke

### Frontfarben/front colours

### Korpusfarben/basic shell colours

#### Dickkante/thick edge

#### PG 1 Dickkante/thick edge

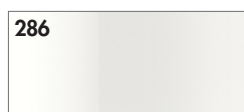

**286**  
**Weiß Seidenglanz**  
*Silk Gloss White*  
BME\_



**286**  
**Weiß Seidenglanz**  
*Silk Gloss White*  
E



**284**  
**Anthrazit Seidenglanz**  
*Silk Gloss Anthracite*  
BMA\_



**284**  
**Anthrazit Seidenglanz**  
*Silk Gloss Anthracite*  
A



**490**  
**Kastanie Graphit Nachbildung**  
*Graphite Chestnut Finish*  
BMC\_



**490**  
**Kastanie Graphit Nachbildung**  
*Graphite Chestnut Finish*  
C



**473**  
**Eiche Struktur Natur Nachbildung**  
*Oak Structure Nature Finish*  
BMM\_



**473**  
**Eiche Struktur Natur Nachbildung**  
*Oak Structure Nature Finish*  
M



**435**  
**Eiche Struktur Weiß Nachbildung**  
*Oak Structure White Finish*  
BML\_



**435**  
**Eiche Struktur Weiß Nachbildung**  
*Oak Structure White Finish*  
L



**426**  
**Eiche Struktur Braun Nachbildung**  
*Oak Structure Brown Finish*  
BMH\_



**426**  
**Eiche Struktur Braun Nachbildung**  
*Oak Structure Brown Finish*  
H

### Frontfarben/front colours

### Korpusfarben/basic shell colours

#### MDF-foliiert/MDF-coated

#### PG 2 Dickkante/thick edge



**952**  
**Rot Glanz**  
*Gloss Red*  
BFR\_



**030**  
**Weiß Matt\***  
*Matt White\**  
W

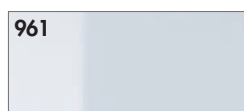

**961**  
**Weiß Glanz**  
*Gloss White*  
BFG\_

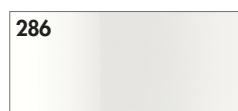

**286**  
**Weiß Seidenglanz**  
*Silk Gloss White*  
E



**438**  
**Anthrazit Glanz**  
*Gloss Anthracite*  
BFF\_



**284**  
**Anthrazit Seidenglanz**  
*Silk Gloss Anthracite*  
A



**449**  
**Kastanie Graphit Nachbildung**  
*Graphite Chestnut Finish*  
BFC\_



**490**  
**Kastanie Graphit Nachbildung**  
*Graphite Chestnut Finish*  
C



**273**  
**Eiche Struktur Natur Nachbildung**  
*Oak Structure Nature Finish*  
BFM\_



**473**  
**Eiche Struktur Natur Nachbildung**  
*Oak Structure Nature Finish*  
M



**235**  
**Eiche Struktur Weiß Nachbildung**  
*Oak Structure White Finish*  
BFL\_



**435**  
**Eiche Struktur Weiß Nachbildung**  
*Oak Structure White Finish*  
L



**226**  
**Eiche Struktur Braun Nachbildung**  
*Oak Structure Brown Finish*  
BFH\_



**426**  
**Eiche Struktur Braun Nachbildung**  
*Oak Structure Brown Finish*  
H

\* Bei Korpus »Weiß Matt« ist die Abdeckplatten vom Beistellschrank »Weiß Glanz«.  
Units with carcass "White Matt" are supplied with a cover plate in "White Gloss".

# »3990bestellschränke« Farb-Varianten/colour options

## Schränke/cabinets 3990bestellschränke

### Frontfarben/front colours

MDF-foliert/MDF-coated



952

**Rot Glanz**  
*Gloss Red*  
BFR\_

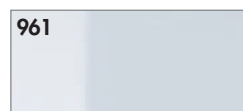

961

**Weiß Glanz**  
*Gloss White*  
BFG\_



438

**Anthrazit Glanz**  
*Gloss Anthracite*  
BFF\_



449

**Kastanie Graphit Nachbildung**  
*Graphite Chestnut Finish*  
BFC\_



273

**Eiche Struktur Natur Nachbildung**  
*Oak Structure Nature Finish*  
BFM\_



235

**Eiche Struktur Weiß Nachbildung**  
*Oak Structure White Finish*  
BFL\_



226

**Eiche Struktur Braun Nachbildung**  
*Oak Structure Brown Finish*  
BFH\_

### Korpusfarben/basic shell colours

PG 3 MDF-foliert/MDF-coated



042

**Weiß Glanz Folie**  
*Gloss White*  
G



438

**Anthrazit Glanz Folie**  
*Gloss Anthracite*  
F

### Regalfarben/shelf colours



287

**Weiß Seidenglanz**  
*Silk Gloss White*  
BM86



474

**Eiche Struktur Natur Nachbildung**  
*Oak Structure Nature Finish*  
BM55



436

**Eiche Struktur Weiß Nachbildung**  
*Oak Structure White Finish*  
BM40



285

**Anthrazit Seidenglanz**  
*Silk Gloss Anthracite*  
BM84



491







**Kastanie Graphit Nachbildung**  
*Graphite Chestnut Finish*  
BM45



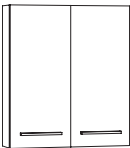



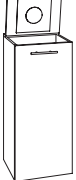

427

**Eiche Struktur Braun Nachbildung**  
*Oak Structure Brown Finish*  
BM70

# 3990beistellschränke »Beistellschränke mit Griff/side cabinets with handle«

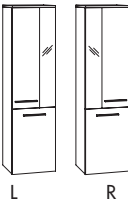
	Beschreibung <i>Description</i>	Maße in cm <i>Dimensions in cm</i>			Artikel-Nr. <i>Article no.</i>	Türanschlag <i>Door stop</i>	Identnummer <i>ID number</i>		
		B/W	H	T/D			PG1	PG2	PG3
	Oberschrank 1 Tür 2 Glaseinlegeböden  <i>top cabinet 1 door 2 glass boards</i>	40,0	68,2	17,6	<b>OT40DL</b> <b>OT40DR</b>	Links/ <i>left</i> Rechts/ <i>right</i>	<b>461</b>	<b>554</b>	<b>623</b>
	Oberschrank 2 Türen 2 Glaseinlegeböden  <i>top cabinet 2 doors 2 glass boards</i>	60,0	68,2	17,6	<b>OT60D</b>		<b>715</b>	<b>923</b>	<b>1016</b>
	Unterschrank inkl. Abdeckplatte 1 Tür, 1 Schubkasten  <i>base cabinet incl. top 1 door, 1 drawer</i>	40,0	49,6	35,0	<b>UST4FL</b> <b>UST4FR</b>	Links/ <i>left</i> Rechts/ <i>right</i>	<b>761</b>	<b>830</b>	<b>1061</b>
	Highboard inkl. Abdeckplatte 1 Tür 2 Glaseinlegeböden  <i>high cabinet incl. top 1 door 2 glass boards</i>	30,0	91,2	35,0	<b>HBT3FL</b> <b>HBT3FR</b>	Links/ <i>left</i> Rechts/ <i>right</i>	<b>646</b>	<b>785</b>	<b>1061</b>
		40,0	91,2	17,6	<b>HBFT4FL</b> <b>HBFT4FR</b>	Links/ <i>left</i> Rechts/ <i>right</i>	<b>646</b>	<b>785</b>	<b>1061</b>
		40,0	91,2	35,0	<b>HBT4FL</b> <b>HBT4FR</b>	Links/ <i>left</i> Rechts/ <i>right</i>	<b>692</b>	<b>830</b>	<b>1176</b>
	Highboard inkl. Abdeckplatte 1 Tür, 1 Schubkasten 2 Glaseinlegeböden  <i>high cabinet incl. top 1 door, 1 drawer 2 glass boards</i>	40,0	91,2	35,0	<b>HBST4FL</b> <b>HBST4FR</b>	Links/ <i>left</i> Rechts/ <i>right</i>	<b>946</b>	<b>1061</b>	<b>1407</b>
	Highboard inkl. Abdeckplatte 1 Tür/Wäschekippe  <i>high cabinet incl. top 1 door/linen bin</i>	40,0	91,2	35,0	<b>HBW4F</b>		<b>716</b>	<b>854</b>	<b>1200</b>
	Schminkschrank inkl. Deckel 1 Tür, 1 Klappe 2 Glaseinlegeböden Kosmetikeinsatz & Vergrößerungsspiegel  <i>make-up cabinet incl. lid 1 door, 1 flap door 2 glass boards cosmetic insert part &amp; magnifying mirror</i>	40,0	91,2	35,0	<b>HBKT4L</b> <b>HBKT4R</b>	Links/ <i>left</i> Rechts/ <i>right</i>	<b>1315</b>	<b>1453</b>	<b>1822</b>
	Mittelschrank inkl. Abdeckplatte 2 Türen 3 Glaseinlegeböden  <i>medium cabinet incl. top 2 doors 3 glass boards</i>	30,0	148,8	35,0	<b>MTT3FL</b> <b>MTT3FR</b>	Links/ <i>left</i> Rechts/ <i>right</i>	<b>969</b>	<b>1176</b>	<b>1638</b>
		40,0	148,8	35,0	<b>MTT4FL</b> <b>MTT4FR</b>	Links/ <i>left</i> Rechts/ <i>right</i>	<b>1085</b>	<b>1292</b>	<b>1753</b>







# 3990beistellschränke »Beistellschränke mit Griff/side cabinets with handle«

Beschreibung Description	Maße in cm Dimensions in cm			Artikel-Nr. Article no.	Türanschlag Door stop	Identnummer ID number		
	B/W	H	T/D			PG1	PG2	PG3
 <p>Mittelschrank inkl. Abdeckplatte 2 Türen, 1 Einschubregal 2 Glaseinlegeböden</p> <p><i>medium cabinet incl. top 2 doors, 1 push-in shelf 2 glass boards</i></p>	40,0	148,8	35,0	<b>MTET4FL MTET4FR</b>	Links/ <i>left</i> Rechts/ <i>right</i>	<b>1292</b>	<b>1476</b>	<b>1937</b>
 <p>Mittelschrank inkl. Abdeckplatte 2 Türen, 1 Schubkasten 3 Glaseinlegeböden</p> <p><i>medium cabinet incl. top 2 doors, 1 drawer 3 glass boards</i></p>	40,0	148,8	35,0	<b>MTST4FL MTST4FR</b>	Links/ <i>left</i> Rechts/ <i>right</i>	<b>1315</b>	<b>1522</b>	<b>1961</b>
 <p>Mittelschrank inkl. Abdeckplatte 1 Tür, 2 Auszüge 2 Glaseinlegeböden</p> <p><i>medium cabinet incl. top 1 door, 2 extensions 2 glass boards</i></p>	40,0	148,8	35,0	<b>MTAA4FL MTAA4FR</b>	Links/ <i>left</i> Rechts/ <i>right</i>	<b>1476</b>	<b>1684</b>	<b>2145</b>
 <p>Mittelschrank inkl. Abdeckplatte 1 Tür, 1 Tür Kombination Holz/satiniertes Glas, 3 Glaseinlegeböden</p> <p><i>medium cabinet incl. top 1 door, 1 door combination wood/ frosted glass, 3 glass boards</i></p> <p>L R</p>	40,0	148,8	35,0	<b>MGT4FL MGT4FR</b>	Links/ <i>left</i> Rechts/ <i>right</i>	<b>1431</b>	<b>1615</b>	<b>2076</b>
 <p>Mittelschrank inkl. Abdeckplatte 4 Türen 3 Glaseinlegeböden</p> <p><i>medium cabinet incl. top 4 doors 3 glass boards</i></p>	60,0	148,8	35,0	<b>MTT6F</b>		<b>1476</b>	<b>1777</b>	<b>2284</b>
 <p>Mittelschrank inkl. Abdeckplatte 4 Türen, 1 Schubkasten 3 Glaseinlegeböden</p> <p><i>medium cabinet incl. top 4 doors, 1 drawer 3 glass boards</i></p>	60,0	148,8	35,0	<b>MTST6F</b>		<b>1707</b>	<b>2007</b>	<b>2514</b>
 <p>Mittelschrank inkl. Abdeckplatte 2 Türen, 2 Auszüge 2 Glaseinlegeböden</p> <p><i>medium cabinet incl. top 2 doors, 2 extensions 2 glass boards</i></p>	60,0	148,8	35,0	<b>MTAA6F</b>		<b>1799</b>	<b>2099</b>	<b>2630</b>
 <p>Glasregal mit Holzrückwand in Korpus- farbe, inkl. Abdeckplatte 7 Glasböden</p> <p><i>glass shelf with wooden back panel in carcase colour, incl. top 7 glass boards</i></p>	33,8	148,8	15,0	<b>MGR33F</b>		<b>2583</b>	-	<b>2769</b>
<b>Bitte Korpusfarbe angeben Please indicate shelf colour</b>								

 Regalfarben unbedingt mit angeben, Übersicht siehe Seite 2. *Please indicate shelf colours, overview see page 2.*

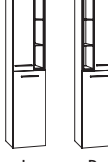

# 3990beistellschränke »Beistellschränke mit Griff/side cabinets with handle«

Beschreibung Description	Maße in cm Dimensions in cm			Artikel-Nr. Article no.	Türanschlag Door stop	Identnummer ID number		
	B/W	H	T/D			PG1	PG2	PG3

						PG1	PG2	PG3	
	Hochschrank 2 Türen 4 Glaseinlegeböden	30,0	178,7	35,0	HTT3L HTT3R	Links/left Rechts/right	1107	1292	1730
	<i>tower cabinet 2 doors 4 glass boards</i>	40,0	178,7	17,6	HFTT4L HFTT4R	Links/left Rechts/right	1107	1292	1730
		40,0	178,7	35,0	HTT4L HTT4R	Links/left Rechts/right	1200	1476	1915
<b>i</b> 	Hochschrank 2 Türen, 1 Einschubregal 4 Glaseinlegeböden	40,0	178,7	35,0	HTET4L HTET4R	Links/left Rechts/right	1476	1707	2145
	<i>tower cabinet 2 doors, 1 push-in shelf 4 glass boards</i>								
	Hochschrank 2 Türen, 1 Schubkasten 3 Glaseinlegeböden	40,0	178,7	35,0	HTST4L HTST4R	Links/left Rechts/right	1499	1753	2169
	<i>tower cabinet 2 doors, 1 drawer 3 glass boards</i>								
	Hochschrank 1 Tür, 1 Tür/Wäscheskippe 2 Glaseinlegeböden	40,0	178,7	35,0	HTW4L HTW4R	Links/left Rechts/right	1246	1500	1937
	<i>tower cabinet 1 door, 1 door/linen bin 2 glass boards</i>								
	Hochschrank 1 Tür, 3 Auszüge 2 Glaseinlegeböden	40,0	178,7	35,0	HTAAA4L HTAAA4R	Links/left Rechts/right	1822	2076	2538
	<i>tower cabinet 1 door, 3 extensions 2 glass boards</i>								
<b>i</b> 	Hochschrank 2 Türen, 1 Einschubregal 4 Glaseinlegeböden	40,0	178,7	35,0	HTRT4L HTRT4R	Links/left Rechts/right	1615	1868	2399
	<i>tower cabinet 2 doors, 1 push-in shelf 4 glass boards</i>								
	Hochschrank 4 Türen 4 Glaseinlegeböden	60,0	178,7	35,0	HTT6		1661	1937	2445
	<i>tower cabinet 4 doors 4 glass boards</i>								
<b>i</b> 	Hochschrank 4 Türen, 1 Einschubregal 4 Glaseinlegeböden	60,0	178,7	35,0	HTET6		1937	2238	2676
	<i>tower cabinet 4 doors, 1 push-in shelf 4 glass boards</i>								

**i** Regalfarben unbedingt mit angeben, Übersicht siehe Seite 2. Please indicate shelf colours, overview see page 2

# 3990beistellschränke »Beistellschränke mit Griff/side cabinets with handle«

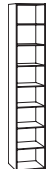
Beschreibung Description	Maße in cm Dimensions in cm			Artikel-Nr. Article no.	Türanschlag Door stop	Identnummer ID number		
	B/W	H	T/D			PG1	PG2	PG3
 <p>Hochschrank 4 Türen, 2 Schubkästen 4 Glaseinlegeböden</p> <p><i>tower cabinet 4 doors, 2 drawers 4 glass boards</i></p>	60,0	178,7	35,0	HTSST6		PG1 2123	PG2 2468	PG3 2929
 <p>Hochschrank 2 Türen, 3 Auszüge 2 Glaseinlegeböden</p> <p><i>tower cabinet 2 doors, 3 extensions 2 glass boards</i></p>	60,0	178,7	35,0	HTAAA6		2238	2607	3045
<b>Hochschrank mit Spiegeltür/tower cabinet with mirrored door</b>						PG1	PG2	PG3
 <p>Hochschrank 2 Spiegeltüren 4 Glaseinlegeböden</p> <p><i>tower cabinet 2 mirrored doors 4 glass boards</i></p>	40,0	178,7	35,0	HPP4L HPP4R	Links/left Rechts/right	1431 BMQ_	-	1868 BFQ_
	40,0	178,7	17,6	HFPP4L HFPP4R	Links/left Rechts/right	1223 BMQ_	-	1661 BFQ_
 <p>Glasregal mit Holzrückwand in Korpus- farbe, inkl. Abdeckplatte 7 Glasböden</p> <p><i>glass shelf with wooden back panel in carcase colour, incl. top 7 glass boards</i></p>	33,8	178,7	15,0	HGR33		2953	-	3160
						Bitte Korpusfarbe angeben Please indicate shelf colour		





informationen &  
produktqualität

*INFORMATION &  
PRODUCT QUALITY*



# Produktqualität & technische Informationen / Product quality & technical information

## Farbunterschiede

Bitte weisen Sie Ihren Kunden darauf hin, dass Fronten, Korpus, Oberboden, Abdeckplatte und Steckboard zwar teilweise identische Farbbezeichnungen haben, jedoch nicht 1:1 im Dekor und Farbton übereinstimmen. Unterschiedliche Licht- und Sonneneinstrahlung führt zu Farbveränderungen. Diese naturbedingten Unterschiede können kein Reklamationsgrund sein. Farbabweichungen gegenüber Mustern und Ausstellungsbädern sind nicht zu vermeiden.

## Korpus

**Weiß Matt, Kastanie Graphit Nachbildung, Eiche Struktur Natur Nachbildung, Eiche Struktur Weiß Nachbildung, Eiche Struktur Braun Nachbildung, Weiß Seidenglanz und Anthrazit Seidenglanz**

Für den Korpus gilt die DIN 68765. Alle verwendeten Platten sind 3-Schichtspanplatten, beidseitig melaminharzbeschichtet und somit sehr reinigungsfreundlich und entsprechen natürlich der gesetzlich vorgeschriebenen Emissionsklasse. Alle Korpuskanten sind beschichtet (rückseitig mit Papierblindkante). Zum besseren Gebrauchsnutzen und Sicherheit sind sämtliche vorderen Korpuskanten (Sichtkanten) mit einer Dickkante belegt.

## Weiß Glanz, Anthrazit Glanz

Für den Korpus gilt die DIN 68765. Alle Platten sind MDF-Platten, einseitig mit einer Glanzkunststoffbeschichtung. Rückseitig mit Melaminharz beschichtet und somit reinigungsfreundlich und entsprechen der gesetzlich vorgeschriebenen Emissionsklasse.

Bei allen Korpusvarianten sind die Rückwände zurückgesetzt und eingetütet, damit eine gute Durchlüftung zwischen Wand und Möbel ermöglicht wird.

Übersicht Dickkante / Folienbeschichtung:

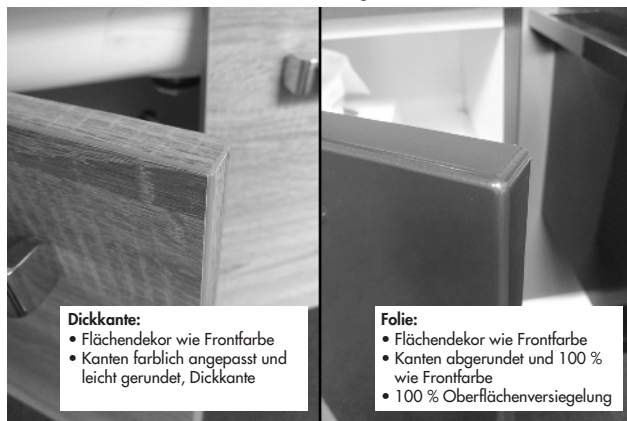

## Ganzmetall-Clipscharniere (inkl. Softclosing)

Die Scharniere sind dreidimensional verstellbar und haben einen Öffnungswinkel von ca. 108° (ausgenommen abgeschrägte Schränke). Dadurch erhält man einen bequemen Zugang zum Schrankinneren. Die Clip-Technik ermöglicht ein leichtes Aus- und Einhängen der Türen ohne Werkzeug. So ist es einfach, den Korpus und die Türkanten gründlich zu reinigen. Mit dem neuen Tüрдämpfungssystem schließen Möbeltüren, selbst wenn sie mit Schwung betätigt werden, sanft und leise. Es passt sich der Schließgeschwindigkeit und dem Gewicht der Tür an.

## Metall-Schubkästen

Die Schubkästen/Auszüge laufen schwebelicht auf verdeckt montierten Führungen – immer als Vollauszug inkl. gedämpftem Selbstzug und Rücklaufsperrle. Alle Schubkästen/Auszüge sind werkzeuglos ein- und auszubauen. Die Fronten sind horizontal je Seite um 1 mm und vertikal um je 2 mm zu verstellen. Zusätzlich kann die Neigung der Front eingestellt werden. Die Tragkraft beträgt insgesamt 30 kg pro Auszug und 30 kg je Schubkasten. Der Stauraum kann bei einem Auszug durch Inneneinteilungen (optional) perfekt untergliedert werden.

## Colour differences

Please inform your customers that although front, basic shell, top panel, cover plate and plug-in board in some cases have identical colour designations, they do not coincide 1:1 in finish and colour. Different ambient light and exposure to sunlight result in colour changes. These natural variations cannot form the basis of a complaint. Colour variations with respect to patterns and display baths cannot be avoided.

## Basic shell

**Matt White, Graphite Chestnut Finish, Oak Structure Nature Finish, Oak Structure White Finish, Oak Structure Brown Finish, Silk Gloss White and Silk Gloss Anthracite**

The basic shell meets the DIN 68765 standard. All the panels used are made of 3-layer chipboard, melamine resin-coated on both sides and hence extremely easy to clean, and of course complying with the legally prescribed emission class. All the basic shell edges are coated (with white edge rear). All the front basic shell edges (visible edges) are covered with a thick edging strip, for better product use and for safety.

## Gloss white, gloss anthracite

DIN 68765 applies to the body. All panels are MDF panels, onesided, with glossy plastic coating. Coated on the back with MF resin and thus easy-to-clean and comply with the legally prescribed emission class.

The rear panels in all the basic shell models are set back and mounted in grooves, enabling good ventilation between wall and furniture.

Overview thick-edging strip / foil coating:

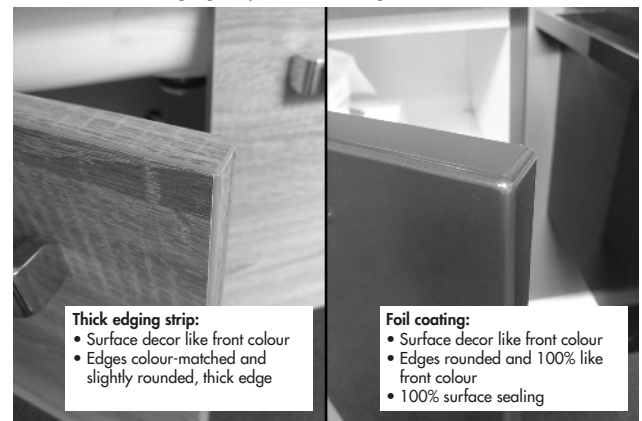

## Full metal clip-on hinges (incl. Softclosing)

The hinges are adjustable in three dimensions, and have an opening angle of ca. 108° (except for bevelled cabinets). This provides easy access to the inside of the cabinet. The clip-on technique enables the doors to be easily hung and removed, without tools. As a result it is easy to clean the basic shell and the door edges thoroughly. With the new door suspension system, the doors close softly and quietly even if they are shut with force. It adjusts itself to the closing speed and weight of the door.

## Metal drawers

The drawers/extensions run as if on air, on concealed runners – fully extending in every case, including damped auto-retract and non-return device. All the drawers/extensions can be fitted and removed without any tools. The fronts can be adjusted horizontally by 1 mm on each side, and vertically by 2mm. The angle of the front panel can also be adjusted. The total permissible load is 30 kg per drawer and 30 kg per drawer. The storage space can be perfectly subdivided by means of internal dividers (optional).

## Die Aufhängung

Zur leichten Montage und perfekten Ausrichtung der Schränke haben wir in der Höhe und Tiefe justierbare Aufhängebeschläge eingesetzt, welche eine Tragfähigkeit von je 75 kg haben und somit ein Höchstmaß an Sicherheit bieten. Sämtliche Schränke sind für eine Wandbefestigung vorgesehen.

Aus sicherheitstechnischen Gründen ist die Wandmontage (Kippsicherung) dringend erforderlich, sonst kann keine Gewährleistung für die Stabilität und Standsicherheit übernommen werden.

Die Wandbeschaffenheit ist vor der Montage unbedingt zu prüfen. Verwendung von Dübeln bei Beton und/oder festem Mauerwerk). Bei abweichender Beschaffenheit (z.B. Rahmenbauweise mit Gipskartonplatten, Leichtbausteinen etc.) ist eine andere, der Belastung angemessene Befestigung bauseits vorzunehmen. Beachten Sie, dass in dem Befestigungsbereich keine Elektro-Installationszonen und keine Ver- oder Entsorgungsleitungen vorhanden sein dürfen. Prüfen Sie mit einem geeigneten Leitungssuchgerät.

## Glasteile

Alle Spiegel und Glasfachböden haben geschliffene Kanten.

## Pflegetips und Hinweise zur Reinigung

1. Reinigen Sie grundsätzlich nur mit weichen angefeuchteten Tüchern, Lederlappen oder Schwammtüchern und trocknen Sie alle Oberflächen nach dem Säubern.

2. Sorgfältige Materialauswahl und ständige Qualitätssicherung sind die Grundlagen unserer Produktfertigung. Unsere Qualität ist für ein normales Badezimmerklima (relative Luftfeuchtigkeit kurzfristig sogar bis 95%) geeignet. Dennoch ist es notwendig, diesen extremen Bedingungen mit ausreichender Be- und Entlüftung entgegen zu wirken und Staunässe zu vermeiden. Ein Aufquellen des Materials durch Einwirkung von Wasser kann nicht als Reklamation anerkannt werden. Entfernen Sie stehendes Wasser also bitte immer sofort und trocknen Sie nach.

3. Geben Sie bei hartnäckigeren Flecken einen milden Haushaltsreiniger oder einen kleinen Schuss Spiritus in das Wasser. Mit einem weichen glatten Tuch wischen Sie die Oberflächen trocken (Weitere Pflegetipps finden Sie in den Angaben des jeweiligen Herstellers von Reinigungs- und Pflegemitteln).

4. Sie sollten nie an einer Stelle herumreiben oder mit Druck reinigen. Was Ihr Bad gar nicht mag: verhärtete schmutzige Lappen, alles was kratzt, ätzt und beißt, wie z.B. Scheuermittel, Fleckenwasser, Nagellackentferner, Möbelpolitur, etc. Diese Reiniger greifen die Oberfläche an.

5. Bei verchromten oder Alu-Zier-/Griffleisten, -Griffen, -Steckdosen, etc. verwenden Sie auf keinen Fall Chromputzmittel. Verfahren Sie hier einfach genau so, wie oben beschrieben.

6. Verwenden Sie keine Möbelpolitur bei Holzdekor-Fronten. Auch hier reicht das Reinigen mit einem feuchten Tuch.

7. Eine regelmäßige Belüftung und Reinigung ist eine Notwendigkeit für den Erhalt von Qualität und Optik Ihrer Möbel.

Wenn Sie diese Tipps anwenden, werden Sie viele Jahre Freude an Ihrem neuen Bad haben.



## Glas Waschtisch

Glas ist ein robustes, hartes Material ohne Schlieren, Einschlüsse oder Rückstände. Es lässt sich leicht reinigen und widersteht Kratzern. Die edle, glänzende Oberfläche wertet zudem jedes Bad auf.

Damit Ihr Glaswaschtisch ebenfalls lange mit der klaren Optik überzeugen kann, haben wir Ihnen ein paar Reinigungstipps zusammengestellt.

Am besten säubern Sie Ihr Waschbecken nur mit einem feuchten Tuch mit Seifenwasser oder neutralen Reinigern. Säurehaltige oder scharfe Putzmittel sind zu vermeiden. Flecken durch Löse-, oder Färbemittel sollten schnell beseitigt werden, damit sie die Oberfläche nicht angreifen. Um Spannungsrissen vorzubeugen, lassen Sie die Wassertemperatur im Becken nicht über 65°C steigen.

## Wall-hanging

To enable easy installation and perfect alignment of the cabinets, we have used wall-hanging fittings with a load-bearing capacity of 75 kg each, thus offering a high degree of safety. All the cabinets are intended for attachment to the wall.

For safety reasons it is urgently recommended to mount the cabinet on the wall (tilt protection) since stability could not be guaranteed otherwise.

Please check the condition of the wall prior to installation (use dowels in case of concret and/or solid brickwork). In case of deviating construction (e.g. frame construction with gypsum plaster boards, breeze blocks etc.) choose another fastening type which corresponds to the applied load. Please note that electrical installation zones and supply and discharge lines must not be present in the mounting area. Please check the wall by means of a suited pipe/cable Detector.

## Glass components

All mirrors and glass shelves have ground edges.

## Care tips and cleaning instructions

1. Generally clean only with a soft damp cloth, chamois or sponge and dry all surfaces.

2. Carefully selected materials and steady quality control are basis of our production. Our quality is suitable for a normal bathroom-climate (relative humidity for a short time up to 95%). However it is necessary to make sure that you have enough ventilation in your bathroom to avoid dammed-up water. Swelling of the material as a result of the effects of water cannot be accepted as a complaint. Remove any water immediately and dry all surfaces.

3. To remove stubborn stains add a mild household cleaner or a small shot of grain alcohol to your water. Dry the surfaces with a soft smooth cloth (you find more care tips and details provided by the manufacturers of your cleaning and care products).

4. Never rub only on one spot or with any pressure. What your bathroom does not like at all: hardened dirty cloths, anything that scratches, etches or burns, such as scouring agents, stain remover, nail-polish remover, furniture polish, etc. These kind of cleaners destroy the surfaces.

5. Never use chrome cleaning agents on chrome-plated or aluminium trim/handle strips, handles, sockets, etc.. Simply proceed exactly as described above..

6. Never use furniture-polish at your wood-décor surfaces. Just clean with a soft damp cloth.

7. Regular ventilation and cleaning is a necessity for a preservation of quality and appearance of your furniture.

If you follow these hints you will rejoice your bathroom furniture for many years.



## Glass washbasin

Glass is a tough and strong material without streaks, enclaves or residues. It is easy to clean and resists scratches. The noble glossy surface enhances the look of every bathroom.

So that your glass washbasin also can assure with it's clear appearance we composed some cleaning hints. The best to clean your washbasin is with a damp cloth and soap-water or natural cleaner. Avoid acidic or harsh detergents. Stains from active solvents or dye have to be removed immediately so they don't harm the surface. Don't let the temperature of the water in the basin rise above 65°C to prevent any cracking.



### Keramik Waschtisch

Die Sanitärkeramik hat eine glatte, dichte und kratzfesten Oberfläche, die gegen alle im Haushalt üblichen Säuren und Laugen resistent ist. Sie brauchen für die tägliche Pflege oft nur klares Wasser und ein feuchtes Tuch.

Altbewährte Reinigungsmittel sind der Haushaltsessig oder die verdünnte Essigsäure, mit denen sich z.B. Kalkablagerungen einfach entfernen lassen. Bei hartnäckigen Flecken können Sie ein in Essig getränktes Haushaltstuch auch einmal über Nacht einwirken lassen. Vorsicht sollten Sie mit allen fluorhaltigen Substanzen sein, die in Rostentfernern und Zahncremes vorkommen können. Hier sollten Sie darauf achten, dass alle Rückstände sofort entfernt werden, da sich bei längerer Einwirkzeit Flecken bilden können.

Manchmal kommt es vor, dass sich Verunreinigungen mit der beschriebenen Pflege nicht entfernen lassen. Hier empfehlen wir Ihnen flüssige oder cremige Badreiniger. Verbessert wird die Wirkung dieser Reiniger noch, wenn Sie einen nicht kratzenden Haushaltsschwamm benutzen.

Weitere Pflegetips finden Sie in den Angaben der jeweiligen Hersteller von Reinigungs- und Pflegemitteln für Sanitärkeramik.



### Mineralmarmor Waschtisch

Wir gratulieren Ihnen zu Ihrem neuen Waschtisch, bei dem wir besonderen Wert auf Qualität, Funktionalität und Design gelegt haben. Ihr Waschtisch besteht aus gemahlenem Stein und Bindemittel. Die Oberfläche des Waschtisches ist mit einer speziellen Deckschicht für Sanitärgebrauch porenfrei versiegelt. Durch den Glanzgrad ist die Oberfläche besonders pflegeleicht und wasserabweisend.

### Sanitär-Armaturen

Verchromte Oberflächen sind empfindlich gegen kalklösende Mittel, säurehaltige Putzmittel und alle Arten von Scheuermitteln. Man empfiehlt kleine Verschmutzungen nur mit Seifenwasser zu entfernen und die Armatur anschließend mit einem Wolltuch zu polieren.

Kalkablagerungen mit Haushaltsessig entfernen. Bei lackierten/farbigen Oberflächen ist die Verwendung von scheuernden, ätzenden oder alkoholhaltigen Reinigungsmitteln unbedingt zu unterlassen. Nur klares Wasser verwenden und mit Wolltuch polieren.

Sollte man eine Verminderung der Wassermenge bemerken, ist eine Reinigung des Luftsprudlers notwendig. Zur Reinigung montiert man den Sprudler ab und spült ihn aus.

### Spiegelschränke/Spiegelpaneele

Entfernen Sie Spritzer, Tropfen und Flecken nur mit einem weichen, trockenen Tuch. Kosmetika und Fettrückstände können mit einem Fensterleder und heißem Wasser ohne Zusatz von Reinigungsmitteln beseitigt werden.

Verwenden Sie bitte keine Chemikalien oder Fensterreiniger. Bei den Spiegelschränken bitte keine Spraydosen auf den Oberboden stellen, aufgrund der Wärmeentwicklung der Beleuchtung entsteht Explosionsgefahr.

Bitte achten Sie darauf, dass die Spiegelkanten möglichst wenig mit Feuchtigkeit in Kontakt kommen. Die Kanten der Spiegel, soweit möglich, immer trocken abwischen, da sich sonst Belagfehler bilden können.

### Damit Sie lange Freude an diesem Produkt haben beachten Sie bitte folgende Hinweise

Reinigen Sie die Oberfläche mit einem weichen Tuch, Schwamm und Flüssigseife (z.B. VISS Badreiniger, AJAX Allzweckreiniger flüssig oder Frosch Zitronenreiniger). Bitte keine groben Schwämme, Scheuermittel oder Scheuermilch verwenden. Hartnäckige Verschmutzungen und Gebrauchsspuren (kleine Kratzer), Brandflecken durch Zigaretten etc. können auch mit einer speziellen Polierpaste beseitigt werden.

Weißliche Flecken, Schlieren und matte Stellen werden häufig durch kalkhaltiges Wasser verursacht. Diese können problemlos mit handelsüblichem Kalkentferner beseitigt werden. Sofort mit viel Wasser nachspülen. Es tut jeder Oberfläche gut, wenn verschüttete Substanzen möglichst sofort entfernt werden. Nagellack- und Haarfärbemittelflecken können auch mit Aceton behandelt werden. Bitte mit ausreichend Wasser nachspülen.



### Ceramic washbasin

Ceramic sanitary ware has a smooth, impermeable and scratchproof surface, which is resistant to the acids and caustic solutions common in the home. For daily maintenance you will often need nothing more than clean water and a damp cloth.

Tried and tested cleaning agents include household vinegar or diluted vinegar concentrate, with which limescale deposits can be easily removed, for example. In the case of stubborn stains you can even apply a vinegar-soaked cloth overnight. You should be cautious with substances containing fluorine, which may be found in rust removers and toothpaste. In this case you should be careful to ensure that all residues are removed immediately, as staining may occur if they are allowed to act on the surface for longer periods.

There are occasions when dirt and discoloration cannot be removed by means of the methods described above. Under these circumstances we recommend the use of liquid or cream bath cleaner. The effect of these cleaners is further enhanced if you use a non-scratch household sponge. Further care tips can be found in the details provided by the manufacturers of each of the cleaning and care products for ceramic sanitary ware.



### Marble mineral washbasin

Congratulations on your new washbasin, for which we have placed particular importance on quality, functionality and design. Your washbasin is made of powdered stone and a bonding agent. The surface of the washbasin is impermeably sealed with a special coating for sanitary use. As a result of its high level of gloss, the surface is especially easy-care and water-repellent.

### Sanitary fittings

Chrome-plated surfaces are sensitive to limescale-removing agents, acidic cleaners and all types of scouring agents. It is recommended that you remove minor soiling with soapy water only, and then polish the fitting with a woollen cloth.

Remove limescale deposits with household vinegar. In the case of painted/coloured surfaces, the use of abrasive, corrosive or alcohol-based cleaning agents is to be avoided at all cost. Use only clean water, and polish with a woollen cloth.

Should you notice a reduction in the flow of water it may be necessary to clean the aerator. To clean the aerator, dismantle it and flush it out.

### Mirror cabinets/mirror panels

Remove splashes, drips and marks with a soft, dry cloth only. Cosmetics and greasy residues can be removed with a chamois leather and hot water, without the addition of any cleaning agents. Please use no chemicals or window cleaners.

Please do not place any aerosol cans on the tops of the mirror cabinets, as heat produced by the light may lead to the risk of an explosion.

Please ensure that the mirror edges are exposed to as little moisture as possible. Always wipe dry the mirror edges if possible as otherwise coating damage could form.

### Please observe the following instructions to ensure lasting enjoyment from this product

Clean the surface with a soft cloth, a sponge and liquid soap (e.g. VISS bath cleaner, AJAX all-purpose liquid cleaner or Frosch lemon cleaner). Please do not use coarse sponges, scouring agents or scouring milk. Stubborn stains and traces of use (small scratches), cigarette burns etc. can also be removed with special polishing paste. Whitish marks, smears and matt spots are frequently caused by hard water. These can be easily removed with commercially available limescale removers. Rinse immediately with plenty of water. It is good for any surface if spilt substances are removed as soon as possible. Nail polish and hair dye marks can also be treated with acetone. Please rinse with plenty of water.

Leicht kreisrunde Polierspuren sind Ausdruck der handwerklichen Fertigung. Diese stellen keinen Grund zur Beanstandung dar. Bitte achten Sie darauf, dass die Wassertemperatur 65°C nicht überschreitet.

Slight circular traces of polish are an expression of the hand-crafted production process. These do not represent any cause for complaint. Please ensure that the water temperature does not exceed 65° C.

### Montagehinweis Mineralmarmor Waschtisch

Vor der Montage ist der Waschtisch auf Transportschäden zu untersuchen. Bei der Montage des Waschtisches ist ein Streifen Silikon auf die Auflagerkanten zu geben. Dann den Waschtisch vorsichtig darauf legen und Wandanschlußseite und Schrankanschlußseite mit Silikon abdichten. Sind nach Montage des Waschtisches noch weitere Fliesenarbeiten oder Spiegelmontagen vorzunehmen, muss der Waschtisch abgedeckt werden.

### Installation notes marble minerals washbasin

The washbasin should be inspected for damage in transit before installation. A strip of silicon sealant should be applied to the supporting edges during installation. Then carefully place the washbasin onto them, and seal the sides adjoining the wall and the cabinet with silicon sealant. The washbasin must be covered if further tiling or mirror fitting work is to be carried out after installation.

### Montagehinweis Keramik Waschtisch

Vor der Montage ist der Waschtisch auf Transportschäden zu untersuchen. Bei der Montage ist die mitgelieferte Montageanleitung zu beachten. Der Waschtisch wird mit speziellen Montageschrauben an der Wand oder mit Silikon auf dem Unterschrank befestigt. Bei beiden Varianten sind die Fugen zur Wand mit Silikon abzudichten. Sind nach der Montage des Waschtisches noch weitere Fliesenarbeiten oder Spiegelmontagen vorzunehmen, muss der Waschtisch abgedeckt werden, um Beschädigungen zu vermeiden.

### Installation notes ceramic washbasin

The washbasin should be inspected for damage in transit before installation. When assembling the washbasin, follow the assembly instructions supplied. The washbasin is fixed to the wall with special mounting screws or to the vanity unit with silicone. With both variants, the joints to the wall must be sealed with silicone. If further tiling or mirror installation is to be carried out after the washbasin has been installed, the washbasin must be covered to prevent damage.

### Technische Änderungen/Toleranzen

Technische Änderungen vorbehalten!

Technische Änderungen wie z.B. eine Formänderung der Überlaufbohrung sind kein Reklamationsgrund. Bitte beachten Sie, dass Maßtoleranzen bis zu 3 mm möglich sind, da jeder Waschtisch individuell für Ihre Kommission hergestellt wird.

### Technical alterations/tolerances

We reserve the right to make technical alterations!

Technical alterations, such as a change to the shape of the overflow, are not a reason for complaint. Please note that dimensional tolerances up to 3 mm are possible, as each washbasin is individually manufactured to order.

## Funktion Überlaufsystem CLOU / function overflow system CLOU

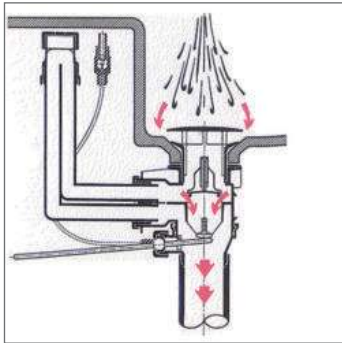

### Geöffnetes Beckenventil

Das Wasser fließt direkt durch das Beckenventil über den Geruchverschluss in die Abwasserleitung.

#### Opened basin drain

The water flows directly through the basin valve over the odour block into the waste water line.

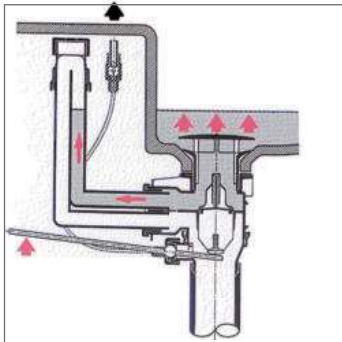

### Geschlossenes Beckenventil

Durch die Betätigung des Exzenters verschließt der Stopfen das Beckenventil. Das Wasser wird in der Keramik sowie im Überlauf gleichmäßig nach dem Prinzip der kommunizierenden Röhren angestaut.

#### Closed basin drain

By actuating the drain valve mechanism, the stopper closes the basin drain. The water accumulates evenly in the basin and the overflow based on the communicating vessels principle.

### Füllstop

Der patentierte Schwimmer, der sich auf dem Stopfen befindet, hebt sich beim Füllstop an und verhindert so ein Zurückströmen des Wassers vom Überlaufrohr in den Waschtisch.

#### Stop valve

The patented float on the stopper is lifted when the basin is filled and prevents the overflow water from flowing back into the basin..

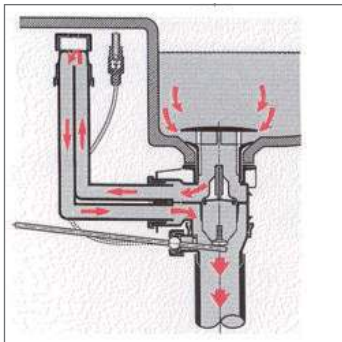

### Überlaufsituation

Erreicht der Wasserstand die Überlaufkante des Überlaufkanals, fließt das nachfließende Wasser im zweigeteilten Überlaufkanal über den Geruchverschluss in die Abwasserleitung.

Das Öffnen des Beckenventils erfolgt durch das Betätigen des Exzenters. Das Wasser fließt ungehindert ab.

#### Overflow situation

If the water level has reached the overflow edge of the overflow drain, the continuing flow of water flows into the divided overflow drain over the odour block into the waste water line.

The basin drain can be opened by actuating the drain valve mechanism. The water is drained without obstruction.

### Technische Daten/technical information

Ablaufleistung nach DIN/Drain capacity as per DIN: 0,42 l/sec

Überlaufleistung/Overflow capacity: 0,25 l/sec

Prüfung/Testing:

Prüfungszeugnis Nr. 219-90 der LGA Würzburg nach DIN 195.545 bzw. EN 274/Test certificate no. 219-90 of LGA Würzburg as per DIN 195.545 and EN 274